

PHILIPS

Data handbook



Electronic
components
and materials

Semiconductors and integrated circuits

Part 3 April 1976

High-frequency transistors

Switching transistors

SEMICONDUCTORS AND INTEGRATED CIRCUITS

Part 3

April 1976

General

High-frequency transistors

Switching transistors

Accessories

Index and maintenance type list

DATA HANDBOOK SYSTEM

Our Data Handbook System is a comprehensive source of information on electronic components, subassemblies and materials; it is made up of three series of handbooks each comprising several parts.

ELECTRON TUBES

BLUE

SEMICONDUCTORS AND INTEGRATED CIRCUITS

RED

COMPONENTS AND MATERIALS

GREEN

The several parts contain all pertinent data available at the time of publication, and each is revised and reissued periodically.

Where ratings or specifications differ from those published in the preceding edition they are pointed out by arrows. Where application information is given it is advisory and does not form part of the product specification.

If you need confirmation that the published data about any of our products are the latest available, please contact our representative. He is at your service and will be glad to answer your inquiries.

This information is furnished for guidance, and with no guarantee as to its accuracy or completeness; its publication conveys no licence under any patent or other right, nor does the publisher assume liability for any consequence of its use; specifications and availability of goods mentioned in it are subject to change without notice; it is not to be reproduced in any way, in whole or in part without the written consent of the publisher.

ELECTRON TUBES (BLUE SERIES)

This series consists of the following parts, issued on the dates indicated.

| | | |
|----------------|--|---------------|
| Part 1a | Transmitting tubes for communication and Tubes for r.f. heating Types PE05/25 ÷ TBW15/125 | December 1975 |
| Part 1b | Transmitting tubes for communication Tubes for r.f. heating Amplifier circuit assemblies | January 1976 |
| Part 2 | Microwave products Communication magnetrons Magnetrons for microwave heating Klystrons Travelling-wave tubes | October 1974 |
| | Diodes Triodes T-R Switches Microwave Semiconductor devices Isolators Circulators | |
| Part 3 | Special Quality tubes; Miscellaneous devices | January 1975 |
| Part 4 | Receiving tubes | March 1975 |
| Part 5a | Cathode-ray tubes | April 1975 |
| Part 5b | Camera tubes; Image intensifier tubes | May 1975 |
| Part 6 | Products for nuclear technology Photodiodes Channel electron multipliers Geiger-Mueller tubes N.B. Photomultiplier tubes and Photo diodes will be issued in Part 9 | July 1975 |
| | Neutron tubes | |
| Part 7 | Gas-filled tubes Voltage stabilizing and reference tubes Counter, selector, and indicator tubes Trigger tubes Switching diodes | August 1975 |
| | Thyratrons Ignitrons Industrial rectifying tubes High-voltage rectifying tubes | |
| Part 8 | TV Picture tubes | October 1975 |

SEMICONDUCTORS AND INTEGRATED CIRCUITS (RED SERIES)

This series consists of the following parts, issued on the dates indicated.

| | | | |
|----------------|---|------------------------------------|----------------------|
| Part 1a | Rectifier diodes, thyristors, triacs | | March 1976 |
| | Rectifier diodes | Rectifier stacks | |
| | Voltage regulator diodes (> 1,5 W) | Thyristors | |
| | Transient suppressor diodes | Triacs | |
| Part 1b | Diodes | | October 1975 |
| | Small signal germanium diodes | Voltage regulator diodes (< 1,5 W) | |
| | Small signal silicon diodes | Voltage reference diodes | |
| | Special diodes | Tuner diodes | |
| Part 2 | Low-frequency transistors | | December 1975 |
| Part 3 | High-frequency and switching transistors | | April 1976 |
| Part 4a | Special semiconductors | | November 1974 |
| | Transmitting transistors | Dual transistors | |
| | Microwave devices | Microminiature devices for | |
| | Field-effect transistors | thick- and thin-film circuits | |
| Part 4b | Devices for optoelectronics | | December 1974 |
| | Photosensitive diodes and transistors | Infrared sensitive devices | |
| | Light emitting diodes | Photoconductive devices | |
| | Photocouplers | | |
| Part 5 | Linear integrated circuits | | March 1975 |
| Part 6 | Digital integrated circuits | | April 1974 |
| | DTL (FC family) | MOS (FD family) | |
| | CML (GX family) | MOS (FE family) | |

COMPONENTS AND MATERIALS (GREEN SERIES)

This series consists of the following parts, issued on the dates indicated.

| | | | |
|----------------|---|---|-----------------------|
| Part 1 | Functional units, Input/output devices, Peripheral devices | | November 1975 |
| | High noise immunity logic FZ/30-Series | Circuit blocks 90-Series | |
| | Circuit blocks 40-Series and CSA70 | Input/output devices | |
| | Counter modules 50-Series | Hybrid integrated circuits | |
| | NORbits 60-Series, 61-Series | Peripheral devices | |
| Part 2a | Resistors | | February 1976 |
| | Fixed resistors | Negative temperature coefficient thermistors (NTC) | |
| | Variable resistors | Positive temperature coefficient thermistors (PTC) | |
| | Voltage dependent resistors (VDR) | Test switches | |
| | Light dependent resistors (LDR) | | |
| Part 2b | Capacitors | | April 1976 |
| | Electrolytic and solid capacitors | Ceramic capacitors | |
| | Paper capacitors and film capacitors | Variable capacitors | |
| Part 3 | Radio, Audio, Television | | February 1975 |
| | FM tuners | Components for black and white television | |
| | Loudspeakers | Components for colour television | |
| | Television tuners and aerial input assemblies | | |
| Part 4a | Soft ferrites | | April 1975 |
| | Ferrites for radio, audio and television | Ferroxcube potcores and square cores | |
| | Beads and chokes | Ferroxcube transformer cores | |
| Part 4b | Piezoelectric ceramics, Permanent magnet materials | | May 1975 |
| Part 5 | Ferrite core memory products | | July 1975 |
| | Ferroxcube memory cores | Core memory systems | |
| | Matrix planes and stacks | | |
| Part 6 | Electric motors and accessories | | September 1975 |
| | Small synchronous motors | Miniature direct current motors | |
| | Stepper motors | | |
| Part 7 | Circuit blocks | | September 1971 |
| | Circuit blocks 100 kHz-Series | Circuit blocks for ferrite core memory drive | |
| | Circuit blocks 1-Series | | |
| | Circuit blocks 10-Series | | |
| Part 8 | Variable mains transformers | | July 1975 |
| Part 9 | Piezoelectric quartz devices | | March 1976 |
| Part 10 | Connectors | | November 1975 |

General

Type designation

Rating systems

Letter symbols

SOAR curves



PRO ELECTRON TYPE DESIGNATION CODE FOR SEMICONDUCTOR DEVICES

This type designation code applies to discrete devices and to multiple devices ¹⁾

The type designation consists of:

TWO LETTERS FOLLOWED BY A SERIAL NUMBER

The first letter gives an indication of the material

- A Material with a band gap of 0.6 to 1.0 eV, such as germanium
- B Material with a band gap of 1.0 to 1.3 eV, such as silicon
- C Material with a band gap of 1.3 eV and more, such as gallium arsenide
- D Material with a band gap of less than 0.6 eV, such as indium antimonide
- R Compound material as employed in Hall generators and photoconductive cells

¹⁾ A multiple device is defined as a combination of similar or dissimilar active devices, contained in a common encapsulation that cannot be dismantled, and of which all electrodes of the individual devices are accessible from the outside.

Multiples of similar devices as well as multiples consisting of a main device and an auxiliary device are designated according to the code for discrete devices described above.

Multiples of dissimilar devices of other nature are designated by the second letter G.

The second letter indicates primarily the main application respectively main application and construction if a further differentiation is essential

- A Detection diode, switching diode, mixer diode
- B Variable capacitance diode
- C Transistor for a.f. applications ($R_{th\ j-mb} > 15\text{ }^{\circ}\text{C/W}$)
- D Power transistor for a.f. applications ($R_{th\ j-mb} \leq 15\text{ }^{\circ}\text{C/W}$)
- E Tunnel diode
- F Transistor for h.f. applications ($R_{th\ j-mb} > 15\text{ }^{\circ}\text{C/W}$)
- G Multiple of dissimilar devices (see note on page 1); Miscellaneous
- H Magnetic sensitive diode; Field probe
- K Hall generator in an open magnetic circuit, e.g. magnetogram or signal probe
- L Power transistor for h.f. applications ($R_{th\ j-mb} \leq 15\text{ }^{\circ}\text{C/W}$)
- M Hall generator in a closed electrically energised magnetic circuit, e.g. Hall modulator or multiplier
- N Photocoupler
- P Radiation sensitive device ¹⁾
- Q Radiation generating device
- R Electrically triggered controlling and switching device having a breakdown characteristic ($R_{th\ j-mb} > 15\text{ }^{\circ}\text{C/W}$)
- S Transistor for switching applications ($R_{th\ j-mb} > 15\text{ }^{\circ}\text{C/W}$)
- T Electrically, or by means of light, triggered controlling and switching power device having a breakdown characteristic ($R_{th\ j-mb} \leq 15\text{ }^{\circ}\text{C/W}$)¹⁾
- U Power transistor for switching applications ($R_{th\ j-mb} \leq 15\text{ }^{\circ}\text{C/W}$)
- X Multiplier diode, e.g. varactor, step recovery diode
- Y Rectifying diode, booster diode, efficiency diode¹⁾
- Z Voltage reference or voltage regulator diode ¹⁾

¹⁾ For the type designation of a range see page 4.

The serial number consists of:

Three figures for semiconductor devices designed primarily for use in domestic equipment

One letter and two figures for semiconductor devices designed primarily for use in professional equipment

VERSION LETTER

A version letter can be used, for instance, for a diode with up-rated voltage, for a sub-division of a transistor type in different gain ranges, a low noise version of an existing transistor and for a diode, transistor, or thyristor with minor mechanical differences, such as finish of the leads, length of the leads etc. The letters never have a fixed meaning, the only exception being the letter R.

TYPE DESIGNATION FOR A RANGE OF SEMICONDUCTOR DEVICES

The type designation of a range of variants of:

- a) voltage reference or voltage regulator diodes (second letter Z)
- b) rectifier diodes (second letter Y)
- c) thyristors (second letter T)
- d) radiation detectors

distinctly belonging to one basic type may be qualified by a suffix part which is clearly separated from the basic part by a hyphen (-)

THE BASIC PART being the same for the whole range, is in accordance with the designation code for discrete devices.

THE SUFFIX PART consists of:

- a) for voltage reference or voltage regulator diodes

one letter followed by the typical working voltage and where appropriate the letter R ¹⁾
The first letter indicates the nominal tolerance of the working voltage in %.

| | |
|---|-----|
| A | 1% |
| B | 2% |
| C | 5% |
| D | 10% |
| E | 15% |

The typical working voltage is related to the nominal current rating for the whole range. The letter V is used to denote the decimal comma when this occurs.

- b) for rectifier diodes

a number and where appropriate the letter R ¹⁾

The number generally indicates the maximum repetitive peak reverse voltage. For controlled avalanche types it indicates the maximum crest working reverse voltage.

- c) for thyristors

a number and where appropriate the letter R ¹⁾

The number generally indicates either the maximum repetitive peak reverse voltage or the maximum repetitive peak off-state voltage, whichever is lower.

For controlled avalanche types it indicates the maximum crest working reverse voltage.

- d) for radiation detectors

a figure giving the depth of the depletion layer in μm and where appropriate a version letter if there are differences in resolution.

¹⁾ The letter R indicates reverse polarity (anode to stud). The normal polarity (cathode to stud) and symmetrical versions are not specially indicated.

RATING SYSTEMS

ACCORDING TO I.E.C. PUBLICATION 134

1. DEFINITIONS OF TERMS USED

1.1 Electronic device. An electronic tube or valve, transistor or other semiconductor device.

Note: This definition excludes inductors, capacitors, resistors and similar components.

1.2 Characteristic. A characteristic is an inherent and measurable property of a device. Such a property may be electrical, mechanical, thermal, hydraulic, electro-magnetic, or nuclear, and can be expressed as a value for stated or recognized conditions. A characteristic may also be a set of related values, usually shown in graphical form.

1.3 Bogey electronic device. An electronic device whose characteristics have the published nominal values for the type. A bogey electronic device for any particular application can be obtained by considering only those characteristics which are directly related to the application.

1.4 Rating. A value which establishes either a limiting capability or a limiting condition for an electronic device. It is determined for specified values of environment and operation, and may be stated in any suitable terms.

Note: Limiting conditions may be either maxima or minima.

1.5 Rating system. The set of principles upon which ratings are established and which determine their interpretation.

Note: The rating system indicates the division of responsibility between the device manufacturer and the circuit designer, with the object of ensuring that the working conditions do not exceed the ratings.

2. ABSOLUTE MAXIMUM RATING SYSTEM

Absolute maximum ratings are limiting values of operating and environmental conditions applicable to any electronic device of a specified type as defined by its published data, which should not be exceeded under the worst probable conditions.

These values are chosen by the device manufacturer to provide acceptable serviceability of the device, taking no responsibility for equipment variations, environmental variations, and the effects of changes in operating conditions due to variations in the characteristics of the device under consideration and of all other electronic devices in the equipment.

p. t. o.

The equipment manufacturer should design so that, initially and throughout life, no absolute maximum value for the intended service is exceeded with any device under the worst probable operating conditions with respect to supply voltage variation, equipment component variation, equipment control adjustment, load variations, signal variation, environmental conditions, and variations in characteristics of the device under consideration and of all other electronic devices in the equipment.

3. DESIGN MAXIMUM RATING SYSTEM

Design maximum ratings are limiting values of operating and environmental conditions applicable to a bogey electronic device of a specified type as defined by its published data, and should not be exceeded under the worst probable conditions.

These values are chosen by the device manufacturer to provide acceptable serviceability of the device, taking responsibility for the effects of changes in operating conditions due to variations in the characteristics of the electronic device under consideration.

The equipment manufacturer should design so that, initially and throughout life, no design maximum value for the intended service is exceeded with a bogey device under the worst probable operating conditions with respect to supply voltage variation, equipment component variation, variation in characteristics of all other devices in the equipment, equipment control adjustment, load variation, signal variation and environmental conditions.

4. DESIGN CENTRE RATING SYSTEM

Design centre ratings are limiting values of operating and environmental conditions applicable to a bogey electronic device of a specified type as defined by its published data, and should not be exceeded under normal conditions.

These values are chosen by the device manufacturer to provide acceptable serviceability of the device in average applications, taking responsibility for normal changes in operating conditions due to rated supply voltage variation, equipment component variation, equipment control adjustment, load variation, signal variation, environmental conditions, and variations in the characteristics of all electronic devices.

The equipment manufacturer should design so that, initially, no design centre value for the intended service is exceeded with a bogey electronic device in equipment operating at the stated normal supply voltage.

NOTE

It is common use to apply the Absolute Maximum System in semiconductor published data.

LETTER SYMBOLS FOR TRANSISTORS AND SIGNAL DIODES

based on IEC Publication 148

LETTER SYMBOLS FOR CURRENTS, VOLTAGES AND POWERS

Basic letters

The basic letters to be used are:

I, i = current
V, v = voltage
P, p = power.

Lower-case basic letters shall be used for the representation of instantaneous values which vary with time.

In all other instances upper-case basic letters shall be used.

Subscripts

| | |
|--------------|--|
| A, a | Anode terminal |
| (AV), (av) | Average value |
| B, b | Base terminal, for MOS devices; Substrate |
| (BR) | Breakdown |
| C, c | Collector terminal |
| D, d | Drain terminal |
| E, e | Emitter terminal |
| F, f | Forward |
| G, g | Gate terminal |
| K, k | Cathode terminal |
| M, m | Peak value |
| O, o | As third subscript: The terminal not mentioned is open circuited |
| R, r | As first subscript: Reverse. As second subscript: Repetitive. |
| | As third subscript: With a specified resistance between the terminal not mentioned and the reference terminal. |
| | R. M. S. value |
| (RMS), (rms) | |
| S, s | As first or second subscript: Source terminal (for FETS only) |
| | As second subscript: Non-repetitive (not for FETS) |
| | As third subscript: Short circuit between the terminal not mentioned and the reference terminal |
| X, x | Specified circuit |
| Z, z | Replaces R to indicate the actual working voltage, current or power of voltage reference and voltage regulator diodes. |

Note: No additional subscript is used for d. c. values.

Upper-case subscripts shall be used for the indication of:

- a) continuous (d. c.) values (without signal)
Example I_B
- b) instantaneous total values
Example i_B
- c) average total values
Example $I_{B(AV)}$
- d) peak total values
Example I_{BM}
- e) root-mean-square total values
Example $I_{B(RMS)}$

Lower-case subscripts shall be used for the indication of values applying to the varying component alone :

- a) instantaneous values
Example i_b
- b) root-mean-square values
Example $I_{b(rms)}$
- c) peak values
Example I_{bm}
- d) average values
Example $I_{b(av)}$

Note: If more than one subscript is used, subscript for which both styles exist shall either be all upper-case or all lower-case.

Additional rules for subscripts

Subscripts for currents

Transistors: If it is necessary to indicate the terminal carrying the current, this should be done by the first subscript (conventional current flow from the external circuit into the terminal is positive).

Examples: I_B, i_B, i_b, I_{bm}

Diodes: To indicate a forward current (conventional current flow into the anode terminal) the subscript F or f should be used; for a reverse current (conventional current flow out of the anode terminal) the subscript R or r should be used.

Examples: $I_F, I_R, i_F, I_{f(rms)}$

Subscripts for voltages

Transistors: If it is necessary to indicate the points between which a voltage is measured, this should be done by the first two subscripts. The first subscript indicates the terminal at which the voltage is measured and the second the reference terminal or the circuit node. Where there is no possibility of confusion, the second subscript may be omitted.

Examples: V_{BE} , v_{BE} , v_{be} , V_{bem}

Diodes: To indicate a forward voltage (anode positive with respect to cathode), the subscript F or f should be used; for a reverse voltage (anode negative with respect to cathode) the subscript R or r should be used.

Examples: V_F , V_R , v_F , V_{rm}

Subscripts for supply voltages or supply currents

Supply voltages or supply currents shall be indicated by repeating the appropriate terminal subscript.

Examples: V_{CC} , I_{EE}

Note: If it is necessary to indicate a reference terminal, this should be done by a third subscript

Example: V_{CCE}

Subscripts for devices having more than one terminal of the same kind

If a device has more than one terminal of the same kind, the subscript is formed by the appropriate letter for the terminal followed by a number; in the case of multiple subscripts, hyphens may be necessary to avoid misunderstanding.

Examples: I_{B2} = continuous (d.c.) current flowing into the second base terminal

V_{B2-E} = continuous (d.c.) voltage between the terminals of second base and emitter

Subscripts for multiple devices

For multiple unit devices, the subscripts are modified by a number preceding the letter subscript; in the case of multiple subscripts, hyphens may be necessary to avoid misunderstanding.

Examples: I_{2C} = continuous (d.c.) current flowing into the collector terminal of the second unit

V_{1C-2C} = continuous (d.c.) voltage between the collector terminals of the first and the second unit.

Application of the rules

The figure below represents a transistor collector current as a function of time. It consists of a continuous (d.c.) current and a varying component.

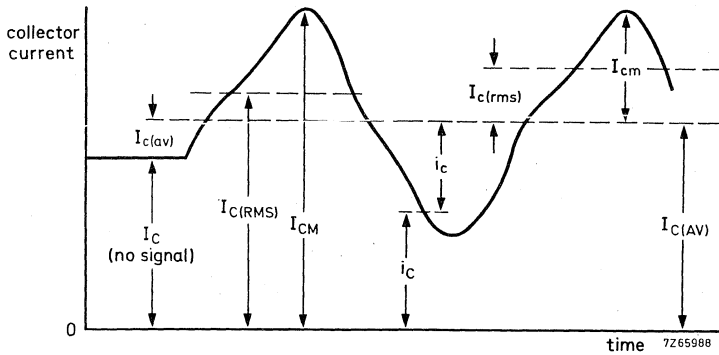

LETTER SYMBOLS FOR ELECTRICAL PARAMETERS

Definition

For the purpose of this Publication, the term "electrical parameter" applies to four-pole matrix parameters, elements of electrical equivalent circuits, electrical impedances and admittances, inductances and capacitances.

Basic letters

The following is a list of the most important basic letters used for electrical parameters of semiconductor devices.

- B, b = susceptance; imaginary part of an admittance
- C = capacitance
- G, g = conductance; real part of an admittance
- H, h = hybrid parameter
- L = inductance
- R, r = resistance; real part of an impedance
- X, x = reactance; imaginary part of an impedance
- Y, y = admittance;
- Z, z = impedance;

Upper-case letters shall be used for the representation of:

- a) electrical parameters of external circuits and of circuits in which the device forms only a part;
- b) all inductances and capacitances.

Lower-case letters shall be used for the representation of electrical parameters inherent in the device (with the exception of inductances and capacitances).

Subscripts

General subscripts

The following is a list of the most important general subscripts used for electrical parameters of semiconductor devices:

| | |
|-------------|-----------------------------|
| F, f | = forward; forward transfer |
| I, i (or 1) | = input |
| L, l | = load |
| O, o (or 2) | = output |
| R, r | = reverse; reverse transfer |
| S, s | = source |

Examples: Z_S , h_f , h_F

The upper-case variant of a subscript shall be used for the designation of static (d.c.) values.

Examples : h_{FE} = static value of forward current transfer ratio in common-emitter configuration (d.c. current gain)

R_E = d.c. value of the external emitter resistance.

Note: The static value is the slope of the line from the origin to the operating point on the appropriate characteristic curve, i.e. the quotient of the appropriate electrical quantities at the operating point.

The lower-case variant of a subscript shall be used for the designation of small-signal values.

Examples: h_{fe} = small-signal value of the short-circuit forward current transfer ratio in common-emitter configuration

$Z_e = R_e + jX_e$ = small-signal value of the external impedance

Note: If more than one subscript is used, subscripts for which both styles exist shall either be all upper-case or all lower-case

Examples: h_{FE} , y_{RE} , h_{fe}

Subscripts for four-pole matrix parameters

The first letter subscript (or double numeric subscript) indicates input, output, forward transfer or reverse transfer

$$\begin{array}{l} \text{Examples: } h_i \text{ (or } h_{11}) \\ h_o \text{ (or } h_{22}) \\ h_f \text{ (or } h_{21}) \\ h_r \text{ (or } h_{12}) \end{array}$$

A further subscript is used for the identification of the circuit configuration. When no confusion is possible, this further subscript may be omitted.

$$\text{Examples: } h_{fe} \text{ (or } h_{21e}), h_{FE} \text{ (or } h_{21E})$$

Distinction between real and imaginary parts

If it is necessary to distinguish between real and imaginary parts of electrical parameters, no additional subscripts should be used. If basic symbols for the real and imaginary parts exist, these may be used.

$$\begin{array}{l} \text{Examples: } Z_i = R_i + jX_i \\ y_{fe} = g_{fe} + jb_{fe} \end{array}$$

If such symbols do not exist or if they are not suitable, the following notation shall be used:

$$\begin{array}{l} \text{Examples: } \text{Re}(h_{ib}) \text{ etc. for the real part of } h_{ib} \\ \text{Im}(h_{ib}) \text{ etc. for the imaginary part of } h_{ib} \end{array}$$

SCATTERING PARAMETERS

In distinction to the conventional h, y and z-parameters, s-parameters relate to traveling wave conditions. The figure below shows a two-port network with the incident and reflected waves a_1 , b_1 , a_2 and b_2 .

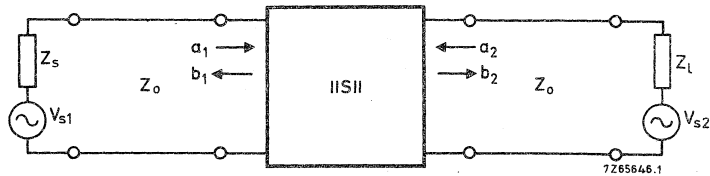

$$a_1 = \frac{V_{i1}}{\sqrt{Z_0}}$$

$$a_2 = \frac{V_{i2}}{\sqrt{Z_0}}$$

$$b_1 = \frac{V_{r1}}{\sqrt{Z_0}}$$

$$b_2 = \frac{V_{r2}}{\sqrt{Z_0}}$$

1)

Z_0 = characteristic impedance of the transmission line in which the two-port is connected.

V_i = incident voltage

V_r = reflected (generated) voltage

The four-pole equations for s-parameters are:

$$b_1 = s_{11}a_1 + s_{12}a_2$$

$$b_2 = s_{21}a_1 + s_{22}a_2$$

Using the subscripts i for 11, r for 12, f for 21 and o for 22, it follows that:

$$s_i = s_{11} = \left. \frac{b_1}{a_1} \right|_{a_2 = 0}$$

$$s_r = s_{12} = \left. \frac{b_1}{a_2} \right|_{a_1 = 0}$$

$$s_f = s_{21} = \left. \frac{b_2}{a_1} \right|_{a_2 = 0}$$

$$s_o = s_{22} = \left. \frac{b_2}{a_2} \right|_{a_1 = 0}$$

1) The squares of these quantities have the dimension of power.

S-PARAMETERS

The s-parameters can be named and expressed as follows:

$s_i = s_{11}$ = Input reflection coefficient.

The complex ratio of the reflected wave and the incident wave at the input, under the conditions $Z_1 = Z_0$ and $V_{s2} = 0$.

$s_r = s_{12}$ = Reverse transmission coefficient.

The complex ratio of the generated wave at the input and the incident wave at the output, under the conditions $Z_s = Z_0$ and $V_{s1} = 0$.

$s_f = s_{21}$ = Forward transmission coefficient.

The complex ratio of the generated wave at the output and the incident wave at the input, under the conditions $Z_1 = Z_0$ and $V_{s2} = 0$.

$s_o = s_{22}$ = Output reflection coefficient.

The complex ratio of the reflected wave and the incident wave at the output, under the conditions $Z_s = Z_0$ and $V_{s1} = 0$.

SAFE OPERATING AREA CURVES

1. D.C. SOAR

The d.c. safe operating area (SOAR) of a transistor is limited on the current axis by $I_{C\text{ max}}$ and on the voltage axis by $V_{CE0\text{ max}}$. Intersecting these two is a third limit defined by $P_{\text{tot max}}$. These limits can be superimposed on the normal I_C - V_{CE} curve as in Fig. 1, but are better shown on a double logarithmic scale as in Fig. 2; the $P_{\text{tot max}}$ limit then appears as a straight line at 45° to the axes.

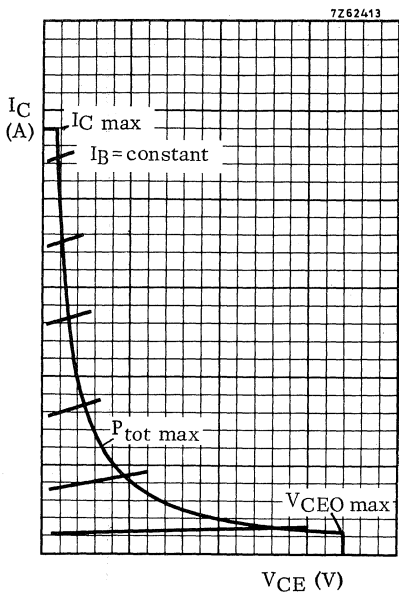

Fig. 1

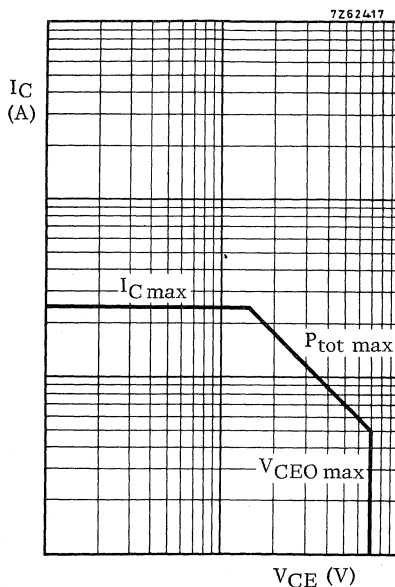

Fig. 2. D.C. SOAR curve

For steady state conditions there is a linear relation between the power dissipated at the junction and the temperature difference between junction and mounting base:

$$T_j - T_{mb} = C \cdot P_{\text{tot}}$$

where $C = R_{\text{th } j\text{-mb}}$, i. e. the thermal resistance from junction to mounting base.

$$T_j - T_{mb} = P_{\text{tot}} \cdot R_{\text{th } j\text{-mb}} \quad (1)$$

In terms of maximum allowable junction temperature eq. (1) can be written as:

$$T_{j\text{ max}} - T_{mb} = P_{\text{tot max}} \cdot R_{\text{th } j\text{-mb}} \quad (1a)$$

The data sheets give an upper limit for $P_{tot\ max}$ which applies up to a temperature T_1 . These relations are shown in Fig. 3 where the upper limit for $P_{tot\ max}$ has been chosen as 100%.

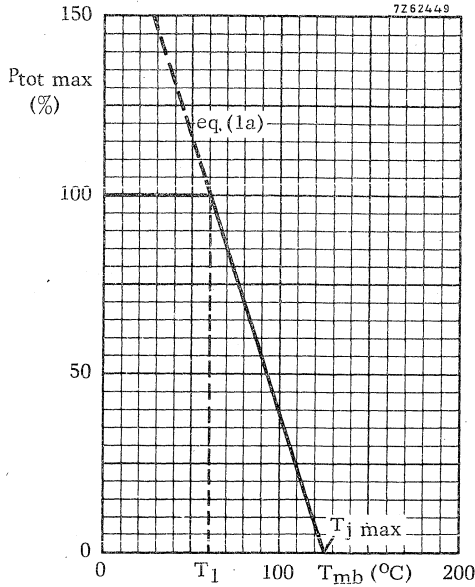

Fig. 3

So far we have discussed only d.c. conditions; it will be obvious that under pulse conditions a higher $P_{tot\ max}$ can be permitted.

2. Extension of the SOAR for pulse power

When pulse power is applied to a transistor the junction temperature will rise in a series of steps until a steady state condition is reached. See Fig. 4.

For this steady state, eq. (1) can be modified to:

$$T_j\ peak - T_{mb} = P_{peak} \cdot Z_{th\ j-mb} \tag{2}$$

where $Z_{th\ j-mb}$ is the transient thermal impedance from junction to mounting base and is dependent not only on $R_{th\ j-mb}$, but also on pulse width (t_p) and period (T). $Z_{th\ j-mb}$ is generally published in the form of Fig. 5.

In terms of maximum allowable junction temperature eq. (2) can be written as:

$$T_j\ max - T_{mb} = P_{peak\ max} \cdot Z_{th\ j-mb} \tag{2a}$$

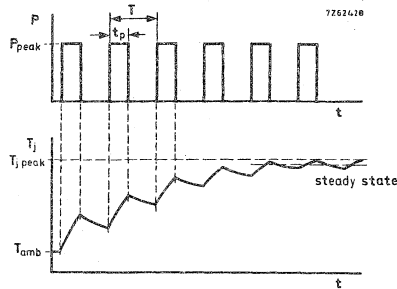

Fig. 4

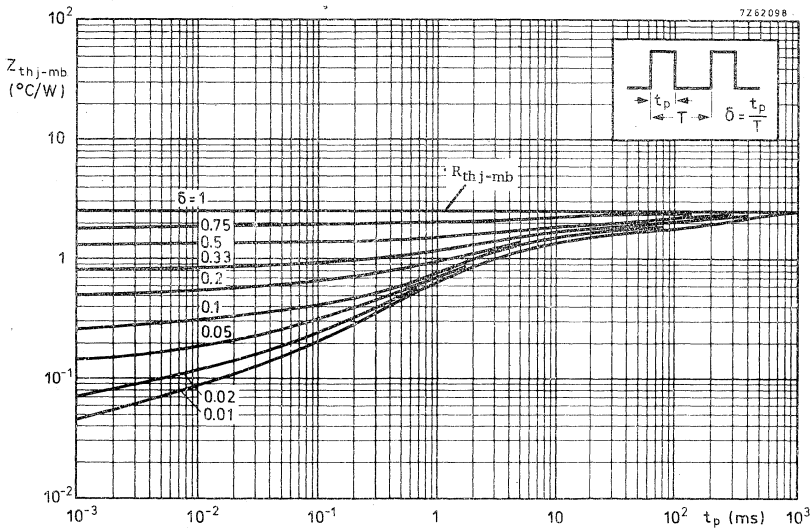

Fig. 5

Dividing eq. (2a) by eq. (1a), leads to:

$$P_{\text{peak max}} = P_{\text{tot max}} \frac{R_{\text{th j-mb}}}{Z_{\text{th j-mb}}} = P_{\text{tot max}} \cdot M_p \quad (3)$$

This means that the $P_{\text{tot max}}$ curve can be shifted by the factor M_p , see the sloping part of the thick dashed line of Fig. 6. M_p is known as the 'power multiplying factor'. The horizontal part of the dashed line of Fig. 6 is the rating I_{CMmax} ; it is the upper limit of the SOAR for pulse conditions.

In addition to the limits set by the SOAR the average current $I_{\text{C(AV)}}$ with an averaging time t_{AV} of 50 ms should not exceed the maximum permissible d.c. current I_{Cmax} . Averaging is not necessary when SOAR limits lower than the rated I_{CMmax} are indicated for different pulse durations.

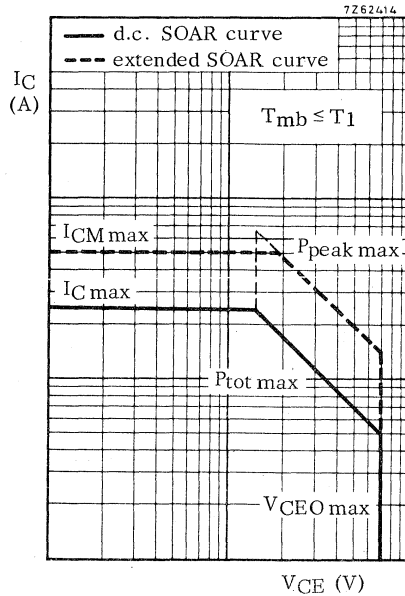

Fig. 6

3. Second Breakdown

3.1 The phenomenon

Primary breakdown is a sudden increase in I_C as a result of avalanche action within the crystal. If the collector current is increased further a critical condition can be reached at which the voltage across the crystal drops to a very low level. This phenomenon is known as second breakdown. It is initiated by a current concentration that leads to local heating within the crystal. The higher the voltage (before second breakdown) the lower the power at which the concentration occurs. If a single point on the crystal exceeds $T_{j\ max}$, the transistor characteristics may be permanently affected; further current concentration will lead to increased temperature and consequent second breakdown, which will destroy the transistor.

The SOAR curve must define an area that only precludes second breakdown but also the current concentration that precedes it.

3.2 Second breakdown and the d.c. SOAR

A transistor's susceptibility to second breakdown is investigated by d.c. loading up to current concentration. With different combinations of I_C and V_{CE} , points are plotted at which current concentration is observed. A limit is then defined that precludes current concentration. This line lowers the original SOAR curve (see Fig. 7). The final d.c. SOAR curve is that shown in Fig. 8. In general the second breakdown limit is independent of the mounting base temperature

The thermal resistance $R_{th\ j-mb}$ is guaranteed for all I_C - V_{CE} combinations within the d.c. SOAR.

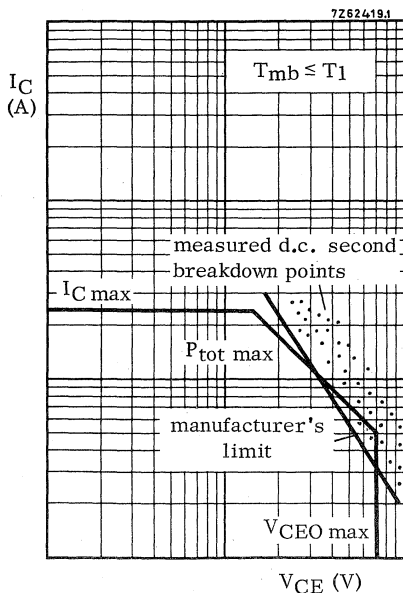

Fig. 7

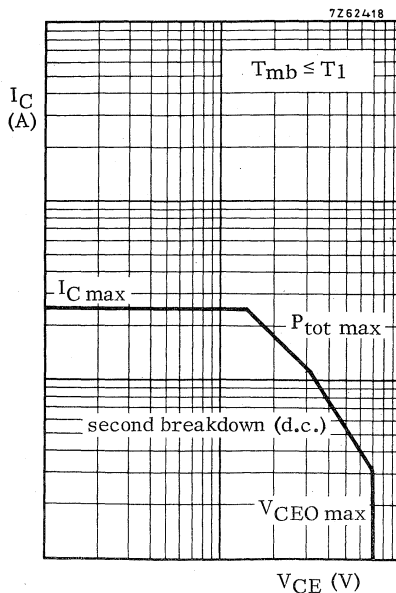

Fig. 8

3.3 Fixing the second breakdown line for pulses, in the SOAR curve

In section 3.1 it was suggested that second breakdown occurs when a single point of the junction (crystal) reaches a critical temperature. It is really the thermal conditions in the crystal itself that determine the point of second breakdown - the thermal resistance (R_{th} crystal) and the thermal impedance (Z_{th} crystal) between the hottest part of the crystal and the rest. Z_{th} crystal is dependent on R_{th} crystal, δ , t_p , and the relation I_C - V_{CE} .

As with M_p , a multiplying factor M_{SB} can be derived to fix the second breakdown line for pulse conditions. However, for second breakdown two multiplying factors are given; $M_{SB(I)}$ is the voltage multiplying factor at the I_{Cmax} level; $M_{SB(V)}$ is the current multiplying factor at the $V_{CEO max}$ level.

Knowing δ and t_p , one can find $M_{SB(I)}$ and $M_{SB(V)}$ from two curves published in the data sheets, Figs 9a and 9b being examples. The voltage value at which the d.c. second breakdown line intersects the I_{Cmax} line is then multiplied by $M_{SB(I)}$. In Fig. 10 the d.c. intersection is shown as point C, and a new intersection for specific pulse conditions as point C'. In the same way $M_{SB(V)}$ is used to find D' from D, which is the point at which the d.c. second breakdown line intersects the $V_{CEO max}$ line. The line that passes through C' and D' defines the second breakdown limit for given values of δ and t_p .

7252411

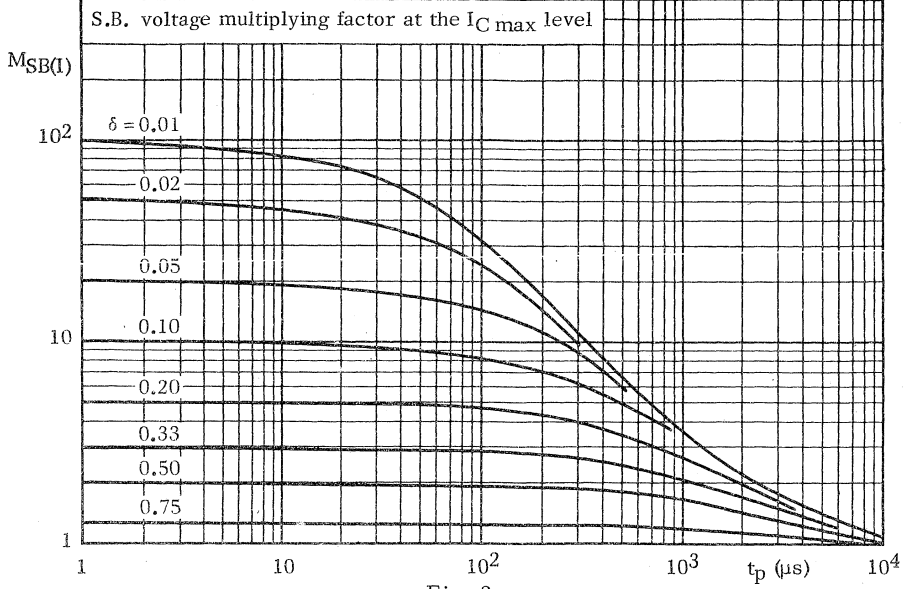

Fig. 9a

7252410

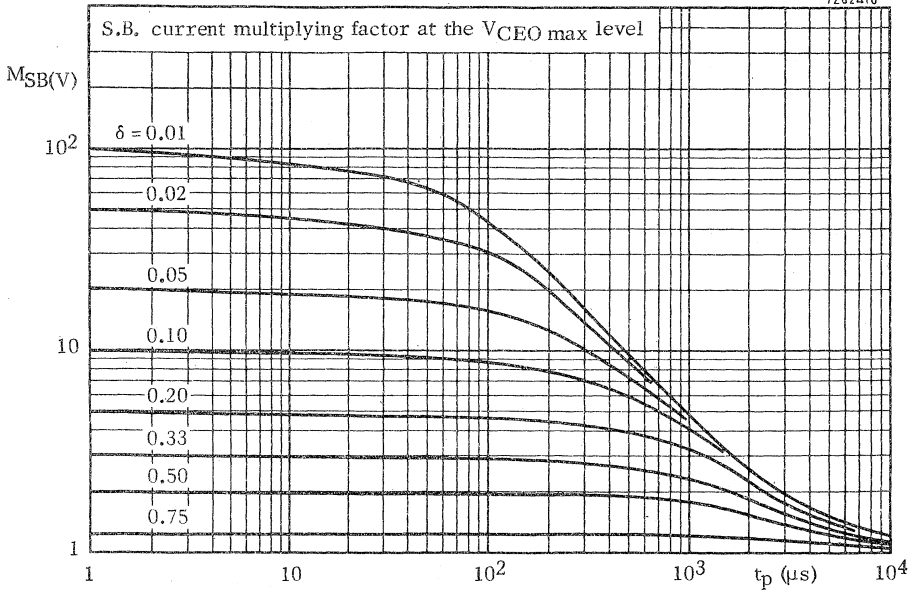

Fig. 9b

7Z62416

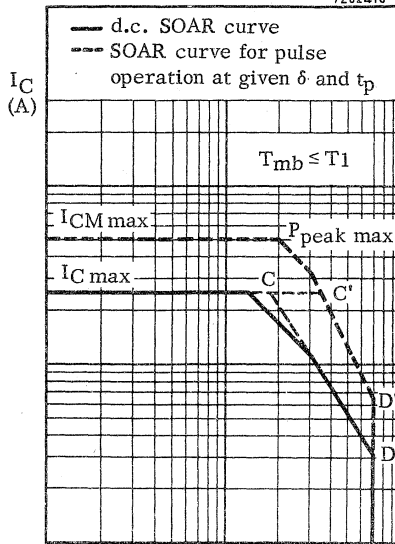

Fig. 10 V_{CE} (V)

A transistor can be safely operated under pulse conditions within the area bounded by $I_{CM \max}$, $P_{\text{peak max}}$, pulse SB limit, and $V_{CEO \max}$, provided the mounting base temperature does not exceed T_1 . If the mounting base temperature does exceed T_1 , M_p must be reduced by a factor derived from Fig. 3 (see section 1) but M_{SB} need not be changed.

The SOAR curve for one specific duty cycle (δ) is given in the data sheets, but with the aid of curves Z_{th} , $M_{SB(I)}$, $M_{SB(V)}$ and the d.c. SOAR, a pulse condition SOAR can be constructed for any duty cycle.

4. Example of how to use the published SOAR information

4.1 Statement of the problem

The driver - and output-stage of an audio amplifier are given in Fig. 11. We shall investigate whether the driver transistor TR3 operates safely under worst case conditions.

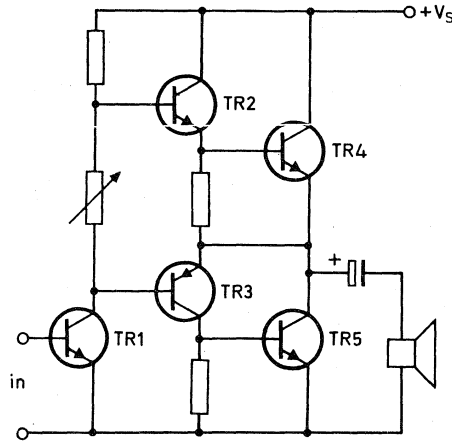

Fig. 11

7Z62427

The loudspeaker impedance is such that worst case conditions occur when the amplifier is overdriven by about 20 times the input signal necessary for full output power at a frequency of 750 Hz. Fig. 12 gives V_{CE} and I_C of TR3 under these conditions. The mounting base temperature of TR3 under these conditions is found to be 85 °C.

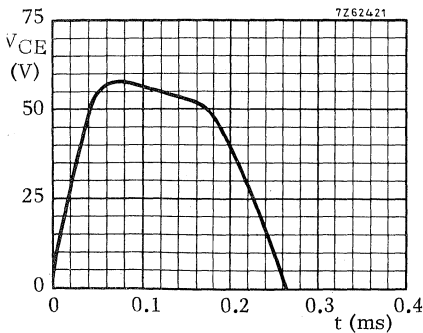

Fig. 12a

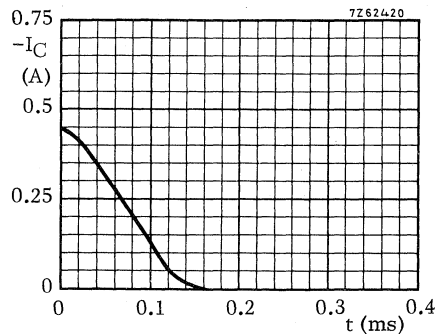

Fig. 12b

4.2 Information obtained from the published data of TR3

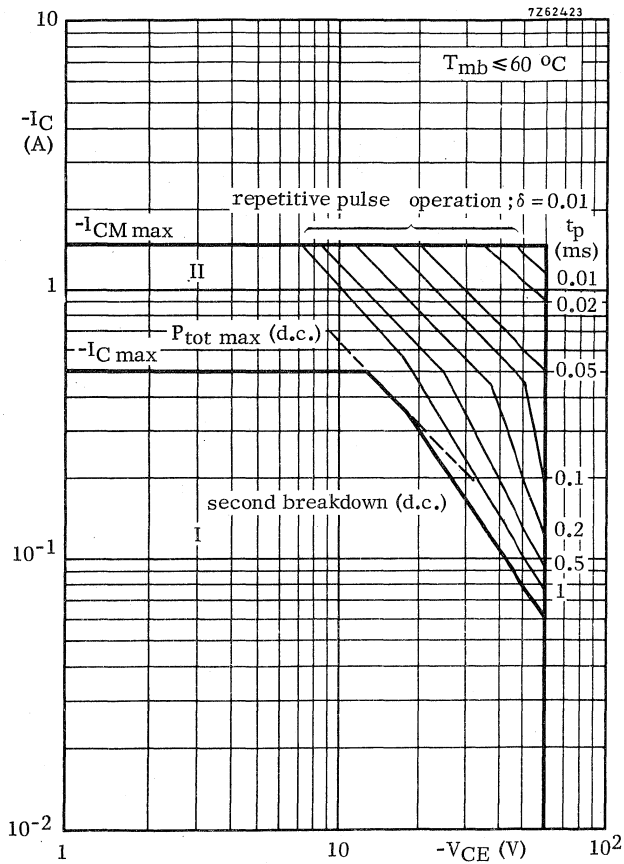
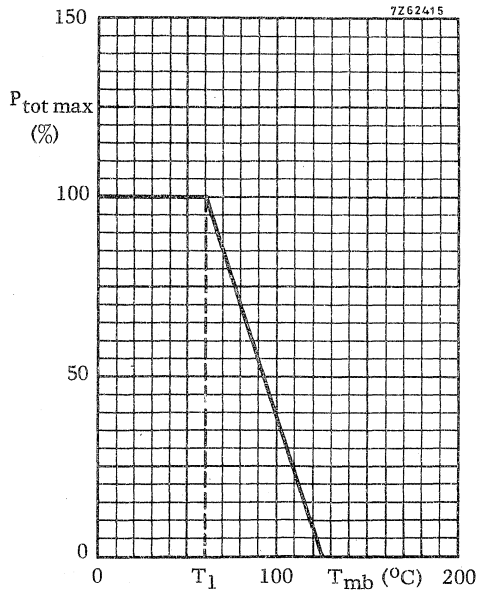

Fig. 13. Safe Operating Area with the transistor forward biased
 I Region of permissible d.c. operation
 II Permissible extension for repetitive pulse operation.



$T_{j\ max} = 125\ ^\circ C$
 $R_{th\ j-mb} = 10\ ^\circ C/W$

Fig. 14

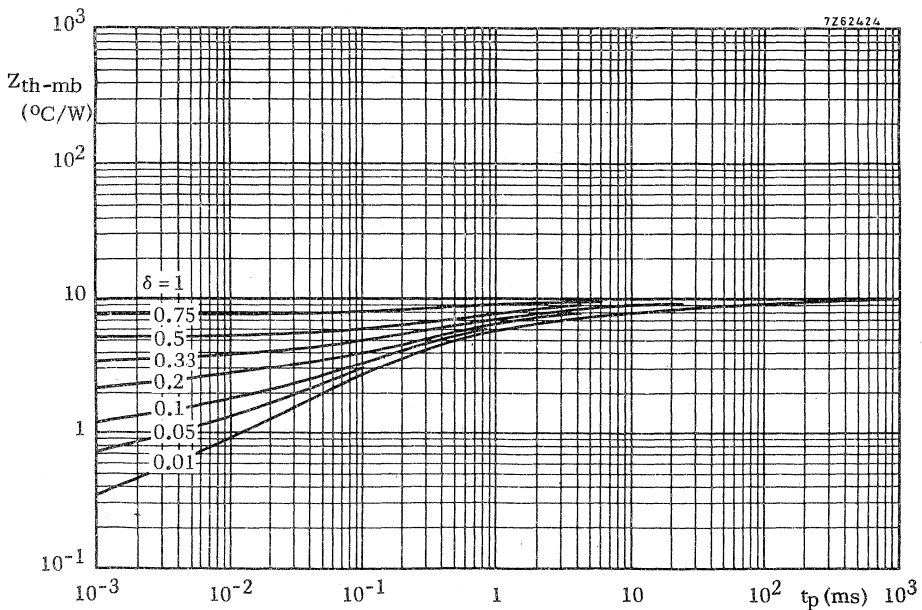

Fig. 15

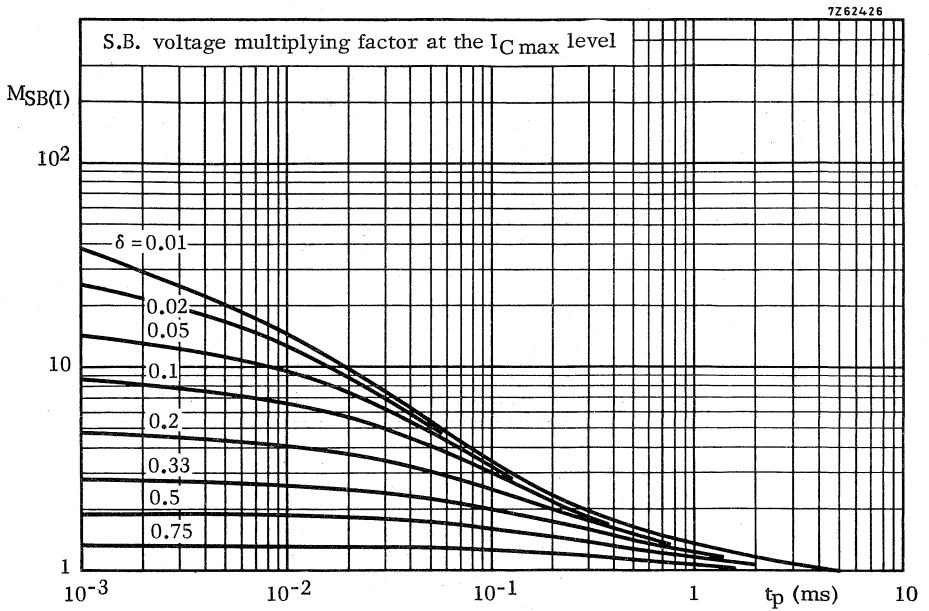

Fig. 16

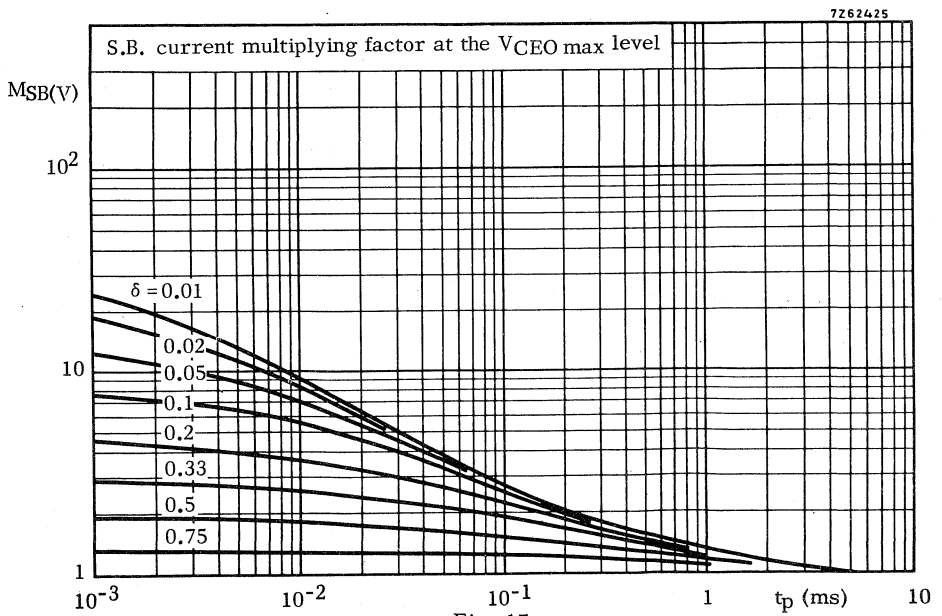

Fig. 17

4.3 Construction of the pulse SOAR of TR3 in this application

4.3.1

Plot the power curve obtained by multiplying the two curves of Fig. 12 and construct an equivalent rectangular power pulse with the same peak value and area as the original pulse. The result is given in Fig. 18.

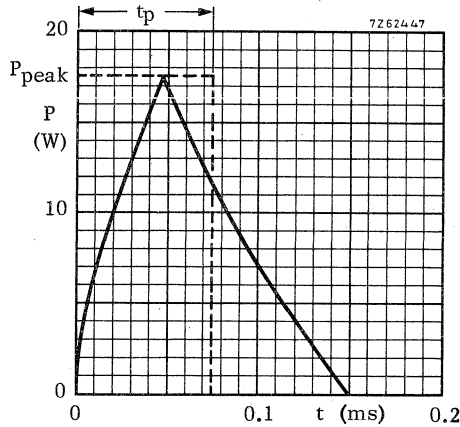

Fig. 18

4.3.2

Ascertain t_p , T , $\delta = t_p/T$ and P_{peak} . The results are:

$$t_p = 75 \mu s$$

$$T = \frac{1}{750} = 1.33 \text{ ms}$$

$$\delta = 0.056$$

$$P_{peak} = 17.5 \text{ W}$$

4.3.3

Refer to Fig. 14 and determine the derating factor for $P_{tot \text{ max}}$ at 85°C . The result is 0.6.

Refer to Fig. 15 and determine $M_p = \frac{R_{th \text{ j-mb}}}{Z_{th \text{ j-mb}}}$ for $t_p = 75 \mu s$ and $\delta = 0.056$.

$$R_{th \text{ j-mb}} = 10 \text{ }^\circ\text{C/W}$$

$$Z_{th \text{ j-mb}} = 2.75 \text{ }^\circ\text{C/W}$$

$$M_p = \frac{10}{2.75} = 3.64$$

4.3.4

Refer to Fig. 16. and 17. and ascertain the M_{SB} factors for $t_p = 75 \mu s$ and $\delta = 0.056$. The results are:

$$M_{SB(I)} = 3.6$$

$$M_{SB(V)} = 2.8$$

4.3.5

Refer to Fig. 13. and construct the pulse extension of the d.c. SOAR for $t_p = 75 \mu s$ and $\delta = 0.056$ according to the following rules (see Fig. 19).

- Multiply the value of the voltage at point A by the derating factor obtained from Fig. 14 (0.6) and by $M_p = 3.64$ to obtain A'.

$$V_A = 13 \text{ V}$$

$$V_{A'} = 13 \text{ V} \times 0.6 \times 3.64 = 28.4 \text{ V}$$

- Through point A' construct a line of constant power (45°)

$$P_{\text{peak max}} = 28.4 \times I_{C \text{ max}} = 14.2 \text{ W.}$$

- Multiply the value of V_{CE} at point C by $M_{SB(I)} = 3.6$ (see 4.3.4), to obtain C'.
- Multiply the value of I_C at point D by $M_{SB(V)} = 2.8$ (see 4.3.4), to obtain D'.
- Construct a new limit for second breakdown by drawing a line through point C' and D'.
- The SOAR for this particular case is formed by the $I_{CM \text{ max}}$ line, the maximum peak dissipation line through A', the second breakdown limit line C'-D' and the V_{CEO} line.

4.3.6

Plot the $I_C - V_{CE}$ excursion as found from Fig. 12a and b in Fig. 19 and check if every point of this excursion is inside the SOAR.

In this particular example the $P_{\text{peak max}}$ limit is exceeded, while the SB-limit is not exceeded. A solution for this case is to decrease the mounting base temperature, T_{mb} , by enlarging the heatsink.

4.3.7

The new permissible mounting base temperature, $T_{mb \text{ max}}$, can be calculated as follows

$$T_{mb \text{ max}} = T_{j \text{ max}} - P_{\text{peak}} \cdot Z_{th \text{ j-mb}}$$

$$P_{\text{peak}} = 17.5 \text{ W (see 4.3.2)}$$

$$Z_{th \text{ j-mb}} = 2.75 \text{ }^\circ\text{C/W}$$

Therefore:

$$T_{mb \text{ max}} = 125 - 17.5 \times 2.75 = 77 \text{ }^\circ\text{C}$$

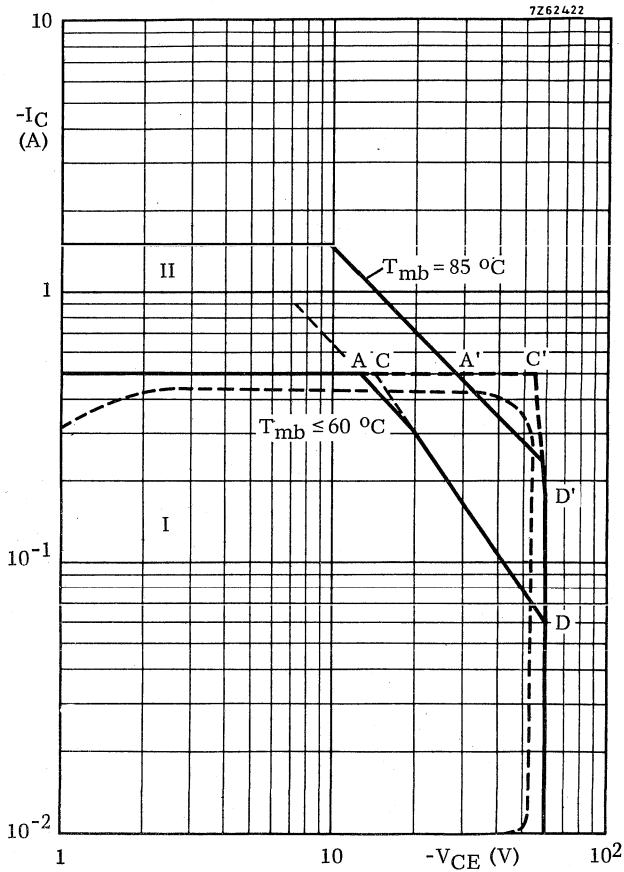

- I Region of permissible operation up to $T_{mb} = 60\text{ }^{\circ}\text{C}$
- II Permissible extension for $t_p = 75\text{ }\mu\text{s}$, $\delta = 0.056$ and $T_{mb} = 85\text{ }^{\circ}\text{C}$

4.3.8

For calculation of the heatsink the power may be averaged provided the period T does not exceed the thermal time constant of the transistor.

$$\text{Then } T_{mb} - T_{amb} = \delta \cdot P_{peak} \cdot R_{th mb-a}$$

If $T_{mb max}$ and P_{peak} are known, the max. allowable $R_{th mb-a}$ may be calculated with

$$R_{th mb-a max} = \frac{T_{mb max} - T_{amb}}{\delta \cdot P_{peak}}$$

$$\text{In our example } R_{th mb-a max} = \frac{77 - 25}{0.056 \times 17.5} = 53 \text{ } ^\circ\text{C/W}$$

High-frequency transistors



RULES FOR SOLDERING LEADS OF PLASTIC "T-PACK" ENVELOPE

Transistors in T-pack envelope may be mounted with leads flat (Fig. 1) or bent (Fig. 2). Different soldering procedures apply for the different styles of mounting.

Flat-lead mounting

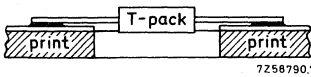

Fig. 1. Flat-lead mounting

Avoid putting any force on the leads during or just after soldering. Solder the three leads one at a time, not simultaneously. Proceed from one lead to the adjacent one, not to the opposite one.

Solder temperature, maximum: 300 °C
 Solder time, maximum: 5 s
 Solder-to-case distance, minimum: 2 mm

Bent-lead mounting

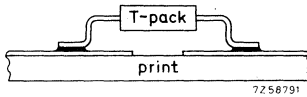

Fig. 2. Bent-lead mounting

If leads are bent, all three may be soldered simultaneously if desired.

Solder temperature, maximum: 300 °C
 Soldering time, maximum: 10 s

RULES FOR MOUNTING QUARTER-INCH CAPSTAN HEADERS AS USED FOR R.F. POWER TRANSISTORS

A 5 mm thick brass nut is supplied with each transistor for securing it to a heatsink. To ensure optimum heat transfer and avoid damage to the threaded stud of the transistor the following recommendations should be observed:

-Diameter of mounting hole in heatsink: 4,10 mm (+0,05; -0,00)

-Heatsink to be at least 3 mm thick.

Attachment to a thinner heatsink may damage the mounting stud.

-Heatsink surfaces at the mounting hole to be flat, parallel, and free of burrs or oxidation.

-Mounting nut torque: 0,80 Nm (+0,05; -0,00)

8,0 kg cm (+0,5 ; -0,0)

If security against vibration is required, use a locking compound such as Lock-tite.

Do not use washers; they impair the heat transfer.

-Recommended distance from the top surface of heatsink to surface of printed wiring board: 2,9 mm (0,0; -0,2)

Tension in the transistor leads sets the limit on spacing between heatsink and printed wiring board; in general, the leads can withstand more pull in the downward than in the upward direction.

-Solder the leads to the connection pads with resin-cored lead-tin solder, using an iron of normal temperature. Soldering iron temperatures as high as 350 °C are safely tolerable; the transistor can withstand an interior temperature of 250 °C for about ten minutes.

The leads may be tinned, if required, by dipping them into a solder bath at about 230 °C; each lead may be dipped up to its full length. A flux of the quality of Super-Safe is recommended; after tinning, surplus flux should be rinsed away in tap water.

CHARACTERISTICS

$T_{amb} = 25\text{ }^{\circ}\text{C}$ unless otherwise specified

Collector cut-off current

$I_E = 0; -V_{CB} = 6\text{ V}$

| | | |
|------------|------|-------------------|
| $-I_{CBO}$ | typ. | 1.2 μA |
| | < | 8 μA |

$I_E = 0; -V_{CB} = 6\text{ V}; T_j = 75\text{ }^{\circ}\text{C}$

| | | |
|------------|------|-------------------|
| $-I_{CBO}$ | typ. | 90 μA |
| | < | 180 μA |

Base current

$I_E = 1\text{ mA}; -V_{CB} = 6\text{ V}$

| | | |
|--------|------|------------------|
| $-I_B$ | typ. | 7 μA |
| | < | 25 μA |

Base-emitter voltage

$-I_C = 1\text{ mA}; -V_{CE} = 6\text{ V}$

| | | |
|-----------|------|---------------|
| $-V_{BE}$ | typ. | 270 mV |
| | | 210 to 330 mV |

Small signal current gain at $f = 1\text{ kHz}$

$-I_C = 1\text{ mA}; -V_{CE} = 6\text{ V}$

| | | |
|----------|------|-----|
| h_{fe} | typ. | 150 |
|----------|------|-----|

Feedback capacitance at $f = 450\text{ kHz}$

$-I_C = 1\text{ mA}; -V_{CE} = 6\text{ V}$

| | | |
|----------|------|--------|
| C_{re} | typ. | 1.5 pF |
|----------|------|--------|

y parameters at $f = 100\text{ MHz}$ (common base)

$I_E = 1\text{ mA}; -V_{CB} = 6\text{ V}$ ¹⁾

Input conductance

| | | |
|----------|------|--------------------------|
| g_{ib} | typ. | 15 $\text{m}\Omega^{-1}$ |
|----------|------|--------------------------|

Input capacitance

| | | |
|-----------|------|------|
| $-C_{ib}$ | typ. | 5 pF |
|-----------|------|------|

Feedback admittance

| | | |
|------------|------|----------------------------|
| $ y_{rb} $ | typ. | 0.45 $\text{m}\Omega^{-1}$ |
|------------|------|----------------------------|

Phase angle of feedback admittance

| | | |
|----------------|------|----------------|
| φ_{rb} | typ. | 250 $^{\circ}$ |
|----------------|------|----------------|

Transfer admittance

| | | |
|------------|------|--------------------------|
| $ y_{fb} $ | typ. | 16 $\text{m}\Omega^{-1}$ |
|------------|------|--------------------------|

Phase angle of transfer admittance

| | | |
|----------------|------|---------------|
| φ_{fb} | typ. | 95 $^{\circ}$ |
|----------------|------|---------------|

Output conductance

| | | |
|----------|------|---------------------------|
| g_{ob} | typ. | 0.3 $\text{m}\Omega^{-1}$ |
|----------|------|---------------------------|

Output capacitance

| | | |
|----------|------|--------|
| C_{ob} | typ. | 2.5 pF |
|----------|------|--------|

Feedback impedance at $f = 2\text{ MHz}$

$I_E = 1\text{ mA}; -V_{CB} = 6\text{ V}$

| | | |
|------------|------|-------------|
| $ z_{rb} $ | typ. | 20 Ω |
|------------|------|-------------|

¹⁾ Length of leads between transistor bottom and measuring jig: 5 mm

CHARACTERISTICS (continued)

$T_{amb} = 25\text{ }^{\circ}\text{C}$ unless otherwise specified

Transition frequency

$I_E = 1\text{ mA}; -V_{CB} = 6\text{ V}$

f_T typ. 75 MHz

Noise figure at $f = 100\text{ MHz}$

$I_E = 1\text{ mA}; -V_{CB} = 6\text{ V}; R_S = 60\text{ }\Omega$

F typ. 8 dB
< 9.5 dB

Power gain at $f = 100\text{ MHz}$

$G_p = \frac{V_o^2}{V_i^2} \cdot \frac{4 R_S}{R_l} = 0.073 \frac{V_o^2}{V_i^2}$

G_p > 12.5 dB
typ. 14 dB

Test circuit

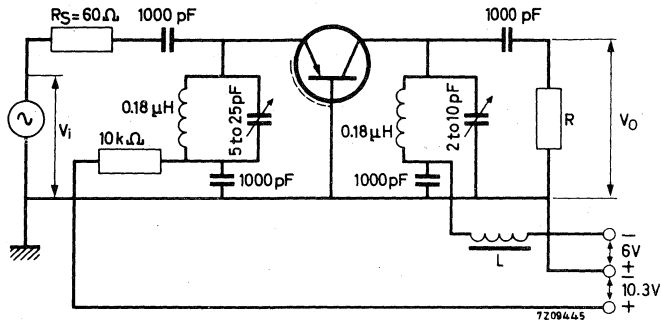

R is chosen such that the total load impedance R_l consisting of R and the tuned circuit in parallel is $3.3\text{ k}\Omega$.

L = ferrite bead

GERMANIUM ALLOY DIFFUSED TRANSISTOR

P-N-P transistor in a TO-72 metal envelope with a shield lead connected to the case. It has a high conversion gain up to frequencies of 100 MHz and is intended for use as r.f. amplifiers and mixer-oscillator in short-wave receivers up to 27 MHz.

RATINGS (Limiting values) 1)

| | | | |
|--|------------|--------------|------------------------------|
| Collector-base voltage (open emitter) | $-V_{CBO}$ | max. | 32 V |
| Collector-emitter voltage ($Z_B/Z_E < 15$) | $-V_{CER}$ | max. | 32 V |
| Collector-emitter voltage (open base) | $-V_{CEO}$ | max. | 15 V |
| Collector current (d.c.) | $-I_C$ | max. | 10 mA |
| Base current (d.c.) | $ I_B $ | max. | 1 mA |
| Reverse emitter current | $-I_E$ | max. | 1 mA |
| Total power dissipation up to $T_{amb} = 45^\circ\text{C}$ | P_{tot} | max. | 60 mW |
| Storage temperature | T_{stg} | | -55 to $+75^\circ\text{C}$ |
| Junction temperature: continuous | T_j | max. | 75°C |
| | | incidentally | max. |

THERMAL RESISTANCE

| | | | |
|--------------------------------------|---------------|---|-------------------------|
| From junction to ambient in free air | $R_{th\ j-a}$ | = | 0.75°C/mW |
| From junction to case | $R_{th\ j-c}$ | = | 0.4°C/mW |

MECHANICAL DATA

Dimensions in mm

TO-72

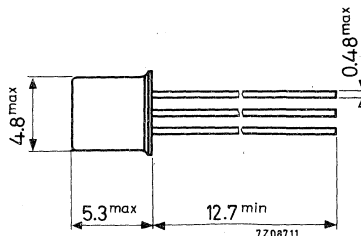
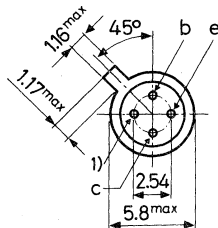

1) = shield lead (connected to case)

Accessories available: 56246, 56263

1) Limiting values according to the Absolute Maximum System as defined in IEC publication 134.

CHARACTERISTICS

$T_{amb} = 25\text{ }^{\circ}\text{C}$ unless otherwise specified

Collector cut-off current

$$I_E = 0; -V_{CB} = 6\text{ V}$$

| | | |
|------------|------|-------------------|
| $-I_{CBO}$ | typ. | 1.2 μA |
| | < | 8 μA |

$$I_E = 0; -V_{CB} = 6\text{ V}; T_j = 75\text{ }^{\circ}\text{C}$$

| | | |
|------------|------|-------------------|
| $-I_{CBO}$ | typ. | 90 μA |
| | < | 180 μA |

Base current

$$I_E = 1\text{ mA}; -V_{CB} = 6\text{ V}$$

| | | |
|--------|------|------------------|
| $-I_B$ | typ. | 7 μA |
| | < | 25 μA |

Base-emitter voltage

$$-I_C = 1\text{ mA}; -V_{CE} = 6\text{ V}$$

| | | |
|-----------|------|---------------|
| $-V_{BE}$ | typ. | 270 mV |
| | | 210 to 330 mV |

Small signal current gain at $f = 1\text{ kHz}$

$$-I_C = 1\text{ mA}; -V_{CE} = 6\text{ V}$$

| | | |
|----------|------|-----|
| h_{fe} | typ. | 150 |
|----------|------|-----|

Feedback capacitance at $f = 450\text{ kHz}$

$$-I_C = 1\text{ mA}; -V_{CE} = 6\text{ V}$$

| | | |
|----------|------|--------|
| C_{re} | typ. | 1.5 pF |
|----------|------|--------|

y parameters 1)

$$I_E = 1\text{ mA}; -V_{CB} = 6\text{ V at } f = 100\text{ MHz}$$

Input conductance

| | | |
|----------|------|--------------------------|
| g_{ib} | typ. | 15 $\text{m}\Omega^{-1}$ |
|----------|------|--------------------------|

Input capacitance

| | | |
|-----------|------|------|
| $-C_{ib}$ | typ. | 5 pF |
|-----------|------|------|

Feedback admittance

| | | |
|------------|------|----------------------------|
| $ Y_{rb} $ | typ. | 0.45 $\text{m}\Omega^{-1}$ |
|------------|------|----------------------------|

Phase angle of feedback admittance

| | | |
|----------------|------|---------------|
| φ_{rb} | typ. | 250° |
|----------------|------|---------------|

Transfer admittance

| | | |
|------------|------|--------------------------|
| $ Y_{fb} $ | typ. | 15 $\text{m}\Omega^{-1}$ |
|------------|------|--------------------------|

Phase angle of transfer admittance

| | | |
|----------------|------|--------------|
| φ_{fb} | typ. | 95° |
|----------------|------|--------------|

Output conductance

| | | |
|----------|------|----------------------------|
| g_{ob} | typ. | 0.35 $\text{m}\Omega^{-1}$ |
|----------|------|----------------------------|

Output capacitance

| | | |
|----------|------|--------|
| C_{ob} | typ. | 2.5 pF |
|----------|------|--------|

$$-I_C = 1\text{ mA}; -V_{CE} = 6\text{ V}$$

Input conductance

| | | $f = 10.7$ | 0.45 MHz |
|----------|------|------------|----------------------------|
| g_{ie} | typ. | 1.3 | 0.25 $\text{m}\Omega^{-1}$ |

Input capacitance

| | | | |
|----------|------|----|-------|
| C_{ie} | typ. | 65 | 70 pF |
|----------|------|----|-------|

Feedback admittance

| | | | |
|------------|------|----|--------------------|
| $ Y_{re} $ | typ. | 80 | 4 $\mu\Omega^{-1}$ |
|------------|------|----|--------------------|

Phase angle of feedback admittance

| | | | |
|----------------|------|---------------|---------------|
| φ_{re} | typ. | 260° | 270° |
|----------------|------|---------------|---------------|

Transfer admittance

| | | | |
|------------|------|----|--------------------------|
| $ Y_{fe} $ | typ. | 34 | 37 $\text{m}\Omega^{-1}$ |
|------------|------|----|--------------------------|

Phase angle of transfer admittance

| | | | |
|----------------|------|---------------|---|
| φ_{fe} | typ. | 335° | 0 |
|----------------|------|---------------|---|

Output conductance

| | | | |
|----------|------|----|----------------------|
| g_{oe} | typ. | 25 | 1.0 $\mu\Omega^{-1}$ |
|----------|------|----|----------------------|

Output capacitance

| | | | |
|----------|------|-----|------|
| C_{oe} | typ. | 3.0 | 4 pF |
|----------|------|-----|------|

1) Length of leads between transistor bottom and measuring jig: 5 mm.

CHARACTERISTICS (continued)

$T_{amb} = 25\text{ }^{\circ}\text{C}$ unless otherwise specified

Feedback impedance at $f = 2\text{ MHz}$

$I_E = 1\text{ mA}; -V_{CB} = 6\text{ V}$ $|z_{rb}|$ typ. 25 Ω

Transition frequency

$I_E = 1\text{ mA}; -V_{CB} = 6\text{ V}$ f_T typ. 75 MHz

Noise figure at $I_E = 1\text{ mA}; -V_{CB} = 6\text{ V}$

$R_S = 60\ \Omega; f = 100\text{ MHz}$ F typ. 9.5 dB

$R_S = 200\ \Omega; f = 10.7\text{ MHz}$ F typ. 3.0 dB

$R_S = 500\ \Omega; f = 1\text{ MHz}$ F typ. 1.5 dB
< 3 dB

Conversion noise figure at $I_E = 1\text{ mA}; -V_{CB} = 6\text{ V}$

$R_S = 500\ \Omega; f = 1\text{ MHz}$ F_C typ. 3 dB
< 5 dB

$R_S = 2\text{ k}\Omega; f = 200\text{ kHz}$ F_C typ. 4 dB
< 7 dB

Power gain at $f = 100\text{ MHz}$

$G_p = \frac{V_o^2}{V_i^2} \cdot \frac{4 R_S}{R_l} = 0.073 \frac{V_o^2}{V_i^2}$ G_p > 10 dB
typ. 13 dB

Test circuit:

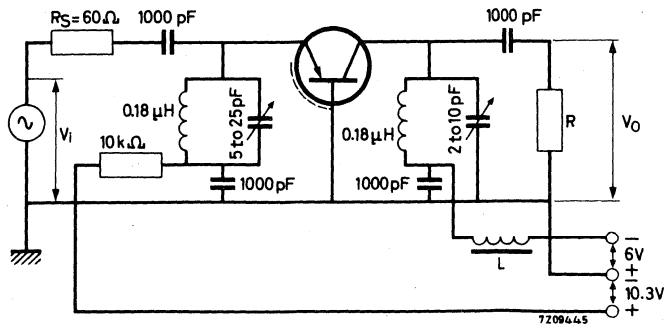

R is chosen such that the total load impedance R_l consisting of R and the tuned circuit in parallel is 3.3 k Ω .

L = ferrite bead

CHARACTERISTICS

$T_{amb} = 25\text{ }^{\circ}\text{C}$ unless otherwise specified

Collector cut-off current

$I_E = 0; -V_{CB} = 6\text{ V}$

| | | |
|------------|------|-------------------|
| $-I_{CBO}$ | typ. | 1.2 μA |
| | < | 8 μA |

$I_E = 0; -V_{CB} = 6\text{ V}; T_j = 75\text{ }^{\circ}\text{C}$

| | | |
|------------|------|-------------------|
| $-I_{CBO}$ | typ. | 90 μA |
| | < | 180 μA |

Base current

$I_E = 1\text{ mA}; -V_{CB} = 6\text{ V}$

| | | |
|--------|------|------------------|
| $-I_B$ | typ. | 7 μA |
| | < | 25 μA |

Base-emitter voltage

$-I_C = 1\text{ mA}; -V_{CE} = 6\text{ V}$

| | | |
|-----------|------|---------------|
| $-V_{BE}$ | typ. | 270 mV |
| | | 210 to 330 mV |

Small signal current gain at $f = 1\text{ kHz}$

$-I_C = 1\text{ mA}; -V_{CE} = 6\text{ V}$

| | | |
|----------|------|-----|
| h_{fe} | typ. | 150 |
|----------|------|-----|

Feedback capacitance at $f = 450\text{ kHz}$

$-I_C = 1\text{ mA}; -V_{CE} = 6\text{ V}$

| | | |
|----------|------|--------|
| C_{re} | typ. | 1.5 pF |
|----------|------|--------|

y parameters (common emitter)

$-I_C = 1\text{ mA}; -V_{CE} = 6\text{ V }^1)$

| | | $f = 10.7$ | 0.45 MHz |
|------------------------------------|----------------|--------------------|-----------------------------|
| Input conductance | g_{ie} | typ. 1.7 | $0.25\text{ m}\Omega^{-1}$ |
| Input capacitance | C_{ie} | typ. 60 | 70 pF |
| Feedback admittance | $ y_{re} $ | typ. 100 | $4.0\text{ }\mu\Omega^{-1}$ |
| Phase angle of feedback admittance | φ_{re} | typ. 260° | 270° |
| Transfer admittance | $ y_{fe} $ | typ. 32 | $37\text{ m}\Omega^{-1}$ |
| Phase angle of transfer admittance | φ_{fe} | typ. 335° | 0 |
| Output conductance | g_{oe} | typ. 40 | $1.0\text{ }\mu\Omega^{-1}$ |
| Output capacitance | C_{oe} | typ. 3.5 | 4.0 pF |

Feedback impedance at $f = 2\text{ MHz}$

$I_E = 1\text{ mA}; -V_{CB} = 6\text{ V}$

| | | |
|------------|------|-------------|
| $ z_{rb} $ | typ. | 27 Ω |
|------------|------|-------------|

¹⁾ Length of leads between transistor bottom and measuring jig : 5 mm

CHARACTERISTICS (continued)

$T_{amb} = 25\text{ }^{\circ}\text{C}$ unless otherwise specified

Transition frequency

$I_E = 1\text{ mA}; -V_{CB} = 6\text{ V}$

f_T typ. 75 MHz

Noise figure at $I_E = 1\text{ mA}; -V_{CB} = 6\text{ V}$

$R_S = 60\text{ }\Omega; f = 10.7\text{ MHz}$

F typ. 3.0 dB
< 4.5 dB

$R_S = 500\text{ }\Omega; f = 1\text{ MHz}$

F typ. 1.5 dB
< 3.0 dB

Conversion noise figure

$I_E = 1\text{ mA}; -V_{CB} = 6\text{ V}$

$R_S = 500\text{ }\Omega; f = 1\text{ MHz}$

F_c typ. 3 dB
< 5 dB

$R_S = 2\text{ k}\Omega; f = 200\text{ kHz}$

F_c typ. 4 dB
< 7 dB

Power gain at $f = 10.7\text{ MHz}$

$$G_P = \frac{V_{O2}^2}{V_i^2} \cdot \frac{4 R_S}{R_1} = 0.1 \frac{V_{O2}^2}{V_i^2}$$

G_P > 19 dB
typ. 25 dB

Test circuit:

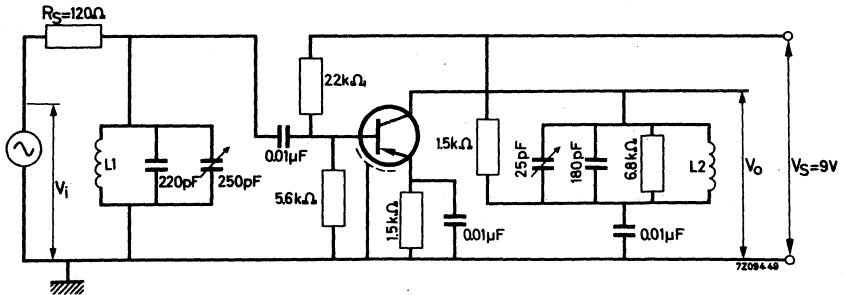

Total collector resistance $R_1 = 4.8\text{ k}\Omega$

$L1 = 0.5\text{ }\mu\text{H};$ unloaded Q-factor 100

$L2 = 2.47\text{ }\mu\text{H};$ unloaded Q-factor 100

CHARACTERISTICS

$T_{amb} = 25\text{ }^{\circ}\text{C}$ unless otherwise specified

Collector cut-off current

$I_E = 0; -V_{CB} = 6\text{ V}$

| | | |
|------------|------|-------------------|
| $-I_{CBO}$ | typ. | 1.2 μA |
| | < | 8 μA |

$I_E = 0; -V_{CB} = 6\text{ V}; T_j = 75\text{ }^{\circ}\text{C}$

| | | |
|------------|------|-------------------|
| $-I_{CBO}$ | typ. | 90 μA |
| | < | 180 μA |

Base current

$I_E = 1\text{ mA}; -V_{CB} = 6\text{ V}$

| | | |
|--------|------|------------------|
| $-I_B$ | typ. | 7 μA |
| | < | 25 μA |

Base-emitter voltage

$-I_C = 1\text{ mA}; -V_{CE} = 6\text{ V}$

| | | |
|-----------|------|---------------|
| $-V_{BE}$ | typ. | 270 mV |
| | | 210 to 330 mV |

Small signal current gain at $f = 1\text{ kHz}$

$-I_C = 1\text{ mA}; -V_{CE} = 6\text{ V}$

| | | |
|----------|------|-----|
| h_{fe} | typ. | 150 |
|----------|------|-----|

Feedback capacitance at $f = 450\text{ kHz}$

$-I_C = 1\text{ mA}; -V_{CE} = 6\text{ V}$

| | | |
|----------|------|--------|
| C_{re} | typ. | 1.5 pF |
|----------|------|--------|

y parameters at $f = 0.45\text{ MHz}$ (common emitter)

$-I_C = 1\text{ mA}; -V_{CE} = 6\text{ V}^1)$

| | | | |
|------------------------------------|----------------|------|----------------------------|
| Input conductance | g_{ie} | typ. | 0.25 $\text{m}\Omega^{-1}$ |
| Input capacitance | C_{ie} | typ. | 70 pF |
| Feedback admittance | $ y_{re} $ | typ. | 4.0 $\mu\Omega^{-1}$ |
| Phase angle of feedback admittance | φ_{re} | typ. | 270° |
| Transfer admittance | $ y_{fe} $ | typ. | 37 $\text{m}\Omega^{-1}$ |
| Phase angle of transfer admittance | φ_{fe} | typ. | 0 |
| Output conductance | g_{oe} | typ. | 1.0 $\mu\Omega^{-1}$ |
| Output capacitance | C_{oe} | typ. | 4.0 pF |

Feedback impedance at $f = 2\text{ MHz}$

$I_E = 1\text{ mA}; -V_{CB} = 6\text{ V}$

| | | |
|------------|------|-------------|
| $ z_{rb} $ | typ. | 35 Ω |
|------------|------|-------------|

¹⁾ Length of leads between transistor bottom and measuring jig : 5 mm

CHARACTERISTICS (continued)

$T_{amb} = 25\text{ }^{\circ}\text{C}$ unless otherwise specified

Transition frequency

$I_E = 1\text{ mA}; -V_{CB} = 6\text{ V}$

f_T typ. 75 MHz

Noise figure at $f = 1.0\text{ MHz}$

$I_E = 1\text{ mA}; -V_{CB} = 6\text{ V}; R_S = 500\text{ }\Omega$

F typ. 1.5 dB
< 3 dB

Conversion noise figure

$I_E = 1\text{ mA}; -V_{CB} = 6\text{ V}$

$R_S = 500\text{ }\Omega; f = 1\text{ MHz}$

F_c typ. 3 dB
< 5 dB

$R_S = 2\text{ k}\Omega; f = 200\text{ kHz}$

F_c typ. 4 dB
< 7 dB

Power gain at $f = 0.45\text{ MHz}$

$$G_p = \frac{V_o^2}{V_i^2} \cdot \frac{4 R_S}{R_L} = 0.94 \frac{V_o^2}{V_i^2}$$

G_p > 40 dB
typ. 42 dB

Test circuit :

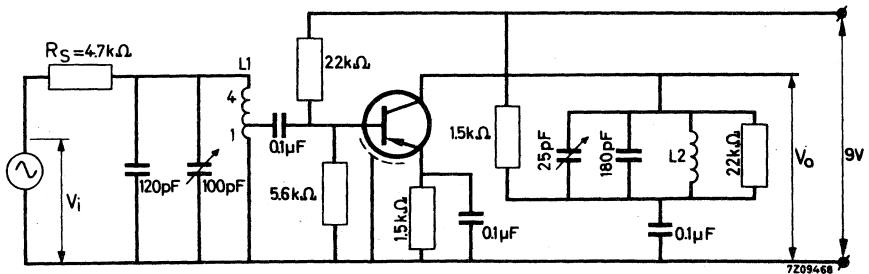

Total collector resistance $R_L = 20\text{ k}\Omega$

$L1 = 625\text{ }\mu\text{H}$; unloaded Q-factor 140; tap at 0.2

$L2 = 625\text{ }\mu\text{H}$; unloaded Q-factor 140

U.H.F. GERMANIUM MESA TRANSISTOR

P-N-P transistor in a TO-72 metal envelope, primarily intended for use in pre-amplifier, mixer or oscillator circuits up to frequencies of 860 MHz.

| QUICK REFERENCE DATA | | |
|---|------------|--------------------------|
| Collector-base voltage (open emitter) | $-V_{CBO}$ | max. 20 V |
| Collector-emitter voltage (open base) | $-V_{CEO}$ | max. 15 V |
| Collector current (d.c.) | $-I_C$ | max. 10 mA |
| Total power dissipation up to $T_{amb} = 45^\circ\text{C}$ | P_{tot} | max. 60 mW |
| Junction temperature | T_j | max. 90 $^\circ\text{C}$ |
| Transition frequency | f_T | typ. 550 MHz |
| $-I_C = 1.5 \text{ mA}; -V_{CE} = 12 \text{ V}$ | | |
| Max. unilateralised power gain | GUM | typ. 11.5 dB |
| $I_E = 1.5 \text{ mA}; -V_{CB} = 12 \text{ V}; f = 800 \text{ MHz}$ | | |
| Noise figure | F | typ. 7 dB |
| $I_E = 1.5 \text{ mA}; -V_{CB} = 12 \text{ V};$ | | |
| $f = 800 \text{ MHz}; R_S = 60 \Omega$ | | |

MECHANICAL DATA

Dimensions in mm

TO-72

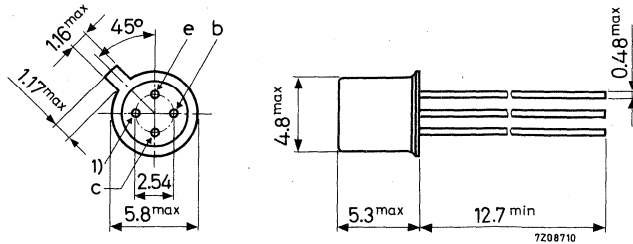

1) = shield lead (connected to case)

Accessories available: 56246, 56263

RATINGS (Limiting values) ¹⁾

Voltages

| | | | |
|---------------------------------------|------------|------|-------|
| Collector-base voltage (open emitter) | $-V_{CBO}$ | max. | 20 V |
| Collector-emitter voltage (open base) | $-V_{CEO}$ | max. | 15 V |
| Emitter-base voltage (open collector) | $-V_{EBO}$ | max. | 0.3 V |

Currents

| | | | |
|--------------------------------|-----------|------|-------|
| Collector current (d.c.) | $-I_C$ | max. | 10 mA |
| Collector current (peak value) | $-I_{CM}$ | max. | 10 mA |

Power dissipation

| | | | |
|--|-----------|------|-------|
| Total power dissipation up to $T_{amb} = 45^\circ\text{C}$ | P_{tot} | max. | 60 mW |
|--|-----------|------|-------|

Temperatures

| | | | |
|----------------------|-----------|------------|---------------------|
| Storage temperature | T_{stg} | -30 to +75 | $^\circ\text{C}$ |
| Junction temperature | T_j | max. | 90 $^\circ\text{C}$ |

THERMAL RESISTANCE

| | | | |
|--------------------------------------|---------------|---|---------------------------------|
| From junction to ambient in free air | $R_{th\ j-a}$ | = | 0.75 $^\circ\text{C}/\text{mW}$ |
| From junction to case | $R_{th\ j-c}$ | = | 0.40 $^\circ\text{C}/\text{mW}$ |

¹⁾ Limiting values according to the Absolute Maximum System as defined in IEC publication 134.

CHARACTERISTICS

$T_j = 25\text{ }^\circ\text{C}$ unless otherwise specified

Collector cut-off current

| | | |
|----------------------------------|------------|---|
| $I_E = 0; -V_{CB} = 20\text{ V}$ | $-I_{CBO}$ | typ. 0.5 μA < 8 μA |
| $I_B = 0; -V_{CE} = 15\text{ V}$ | $-I_{CEO}$ | < 500 μA |

Emitter cut-off current

| | | |
|-----------------------------------|------------|---|
| $I_C = 0; -V_{EB} = 0.3\text{ V}$ | $-I_{EBO}$ | typ. 2 μA < 100 μA |
|-----------------------------------|------------|---|

Base current

| | | |
|--|--------|--|
| $I_E = 1.5\text{ mA}; -V_{CB} = 12\text{ V}$ | $-I_B$ | typ. 30 μA < 150 μA |
| $I_E = 2\text{ mA}; -V_{CB} = 6\text{ V}$ | $-I_B$ | typ. 36 μA |
| $I_E = 5\text{ mA}; -V_{CB} = 6\text{ V}$ | $-I_B$ | typ. 66 μA |

Emitter-base voltage

| | | |
|--|----------|------------------------------|
| $I_E = 1.5\text{ mA}; -V_{CB} = 12\text{ V}$ | V_{EB} | typ. 380 mV 320 to 430 mV |
| $I_E = 2\text{ mA}; -V_{CB} = 6\text{ V}$ | V_{EB} | typ. 380 mV 320 to 430 mV |
| $I_E = 5\text{ mA}; -V_{CB} = 6\text{ V}$ | V_{EB} | typ. 405 mV 360 to 450 mV |

Transition frequency

| | | |
|---|-------|--------------|
| $-I_C = 1.5\text{ mA}; -V_{CE} = 12\text{ V}$ | f_T | typ. 550 MHz |
|---|-------|--------------|

Reverse transfer time constant

| | | |
|--|-------------------------|-----------|
| $I_E = 1.5\text{ mA}; -V_{CB} = 12\text{ V}; f = 2.5\text{ MHz}$ | $r_{bb'} \cdot C_{b'c}$ | typ. 3 ps |
|--|-------------------------|-----------|

Feedback capacitance at $f = 450\text{ kHz}$

| | | |
|---|----------|---------------------------|
| $-I_C = 1.5\text{ mA}; -V_{CE} = 12\text{ V}$ | C_{re} | typ. 250 fF ¹⁾ |
|---|----------|---------------------------|

Noise figure at $R_S = 60\ \Omega$

| | | |
|--|---|-------------------------|
| $I_E = 1.5\text{ mA}; -V_{CB} = 12\text{ V}; f = 800\text{ MHz}$ | F | typ. 7 dB < 8.2 dB |
| $f = 860\text{ MHz}$ | F | typ. 7.5 dB < 8.8 dB |

¹⁾ 1 fF = 1 femtofarad = 10^{-15} F

CHARACTERISTICS (continued)

$T_j = 25\text{ }^\circ\text{C}$ unless otherwise specified

y parameters at $f = 800\text{ MHz}$ ¹⁾

$I_E = 1.5\text{ mA}; -V_{CB} = 12\text{ V}$

| | | | |
|------------------------------------|------------------|------|---------------------------|
| Input conductance | g_{ib} | typ. | $7\text{ m}\Omega^{-1}$ |
| Input capacitance | $-C_{ib}$ | typ. | 2.2 pF |
| Input susceptance | $-\omega C_{ib}$ | typ. | $11\text{ m}\Omega^{-1}$ |
| Feedback admittance | $ y_{rb} $ | typ. | $0.4\text{ m}\Omega^{-1}$ |
| Phase angle of feedback admittance | φ_{rb} | typ. | 240° |
| Transfer admittance | $ y_{fb} $ | typ. | $14\text{ m}\Omega^{-1}$ |
| Phase angle of transfer admittance | φ_{fb} | typ. | 35° |
| Output conductance | g_{ob} | typ. | $0.5\text{ m}\Omega^{-1}$ |
| Output capacitance | C_{ob} | typ. | 1.5 pF |

y parameters at $f = 200\text{ MHz}$ ¹⁾

$I_E = 1.5\text{ mA}; -V_{CB} = 12\text{ V}$

| | | | |
|------------------------------------|------------------|------|----------------------------|
| Input conductance | g_{ib} | typ. | $28\text{ m}\Omega^{-1}$ |
| Input capacitance | $-C_{ib}$ | typ. | 19 pF |
| Input susceptance | $-\omega C_{ib}$ | typ. | $24\text{ m}\Omega^{-1}$ |
| Feedback admittance | $ y_{rb} $ | typ. | $0.17\text{ m}\Omega^{-1}$ |
| Phase angle of feedback admittance | φ_{rb} | typ. | 250° |
| Transfer admittance | $ y_{fb} $ | typ. | $37\text{ m}\Omega^{-1}$ |
| Phase angle of transfer admittance | φ_{fb} | typ. | 126° |
| Output conductance | g_{ob} | typ. | $90\text{ }\mu\Omega^{-1}$ |
| Output capacitance | C_{ob} | typ. | 1.5 pF |

Maximum unilateralised power gain

$$G_{UM} = \frac{|y_{fb}|^2}{4 g_{ib}g_{ob}}$$

$I_E = 1.5\text{ mA}; -V_{CB} = 12\text{ V}; f = 800\text{ MHz}$ G_{UM} typ. 11.5 dB

¹⁾ Measured with a lead length of 5 mm.

CHARACTERISTICS (continued)

$T_j = 25\text{ }^\circ\text{C}$ unless otherwise specified

Transducer gain

Basic circuit for measuring the transducer gain G_{tr} .

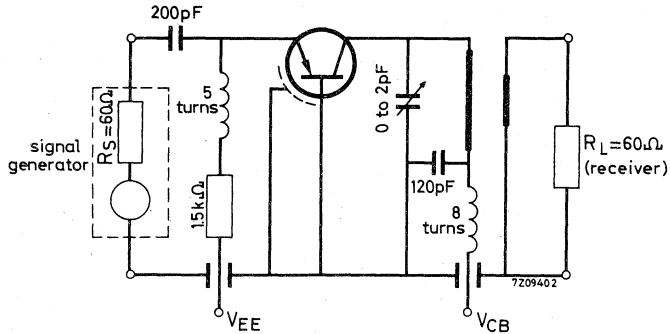

Total effective collector resistance $R_C = 1.4\text{ k}\Omega$

$$G_{tr} = \frac{\text{output power in load } R_L}{\text{available power from source } R_S}$$

$I_E = 1.5\text{ mA}$; $-V_{CB} = 12\text{ V}$

$f = 800\text{ MHz}$

$G_{tr} > 9\text{ dB}$
typ. 11 dB

$f = 860\text{ MHz}$

$G_{tr} > 7.5\text{ dB}$
typ. 10 dB

Reverse transducer gain

$I_E = 1.5\text{ mA}$; $-V_{CB} = 12\text{ V}$; $f = 800\text{ MHz}$

$G_{tr\text{ rev}}$ typ. -23 dB

The reverse transducer gain is measured in the above circuit, with the signal generator and the load (receiver) interchanged.

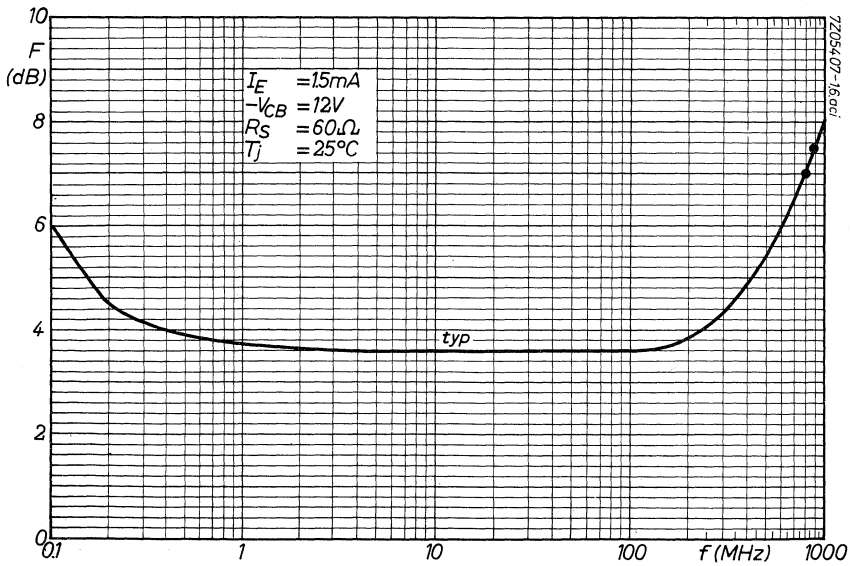
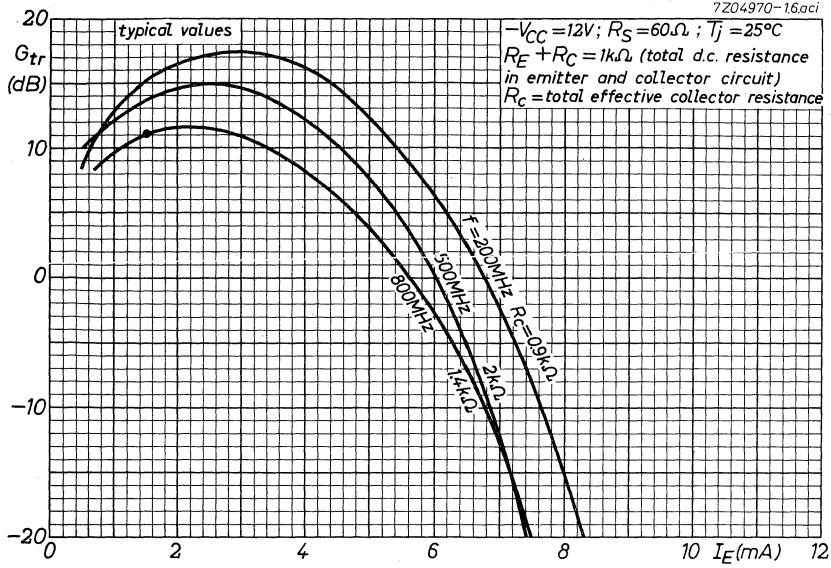

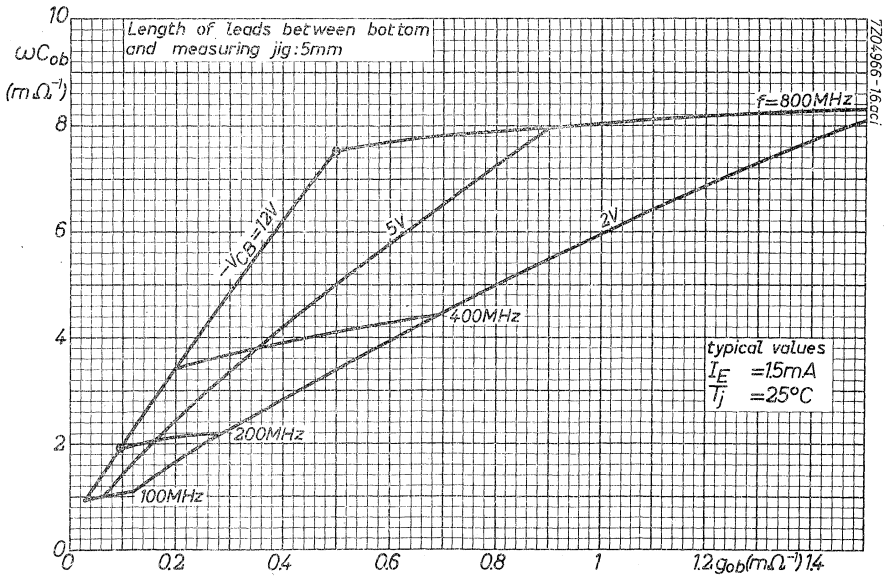
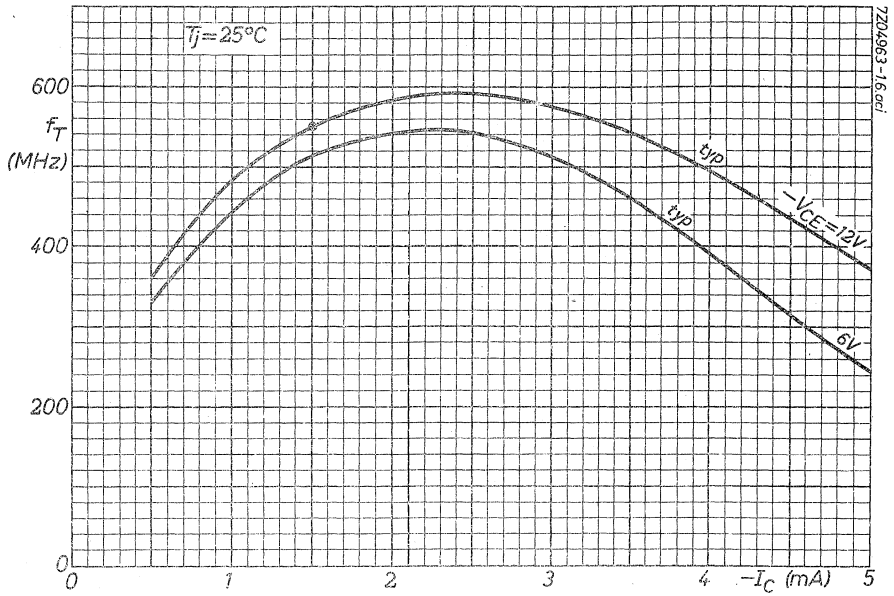

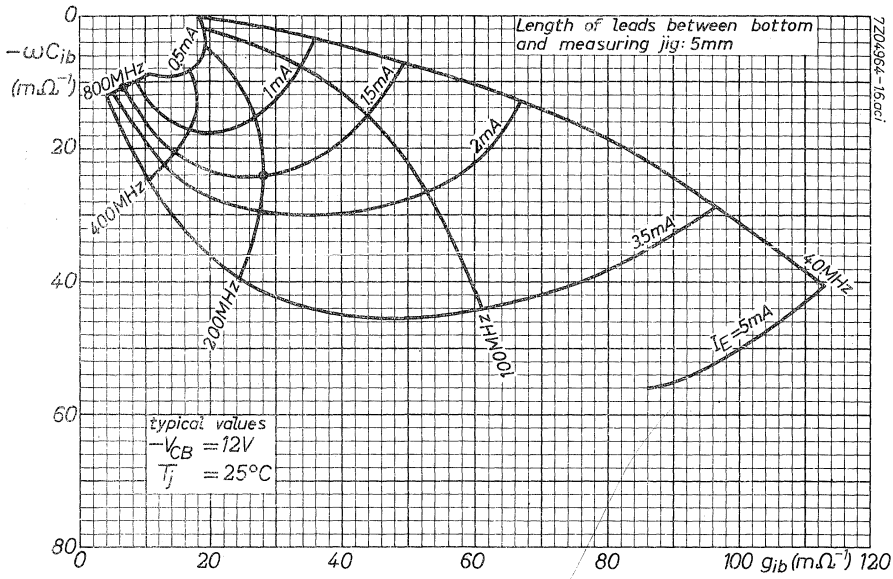

7204964-16aci

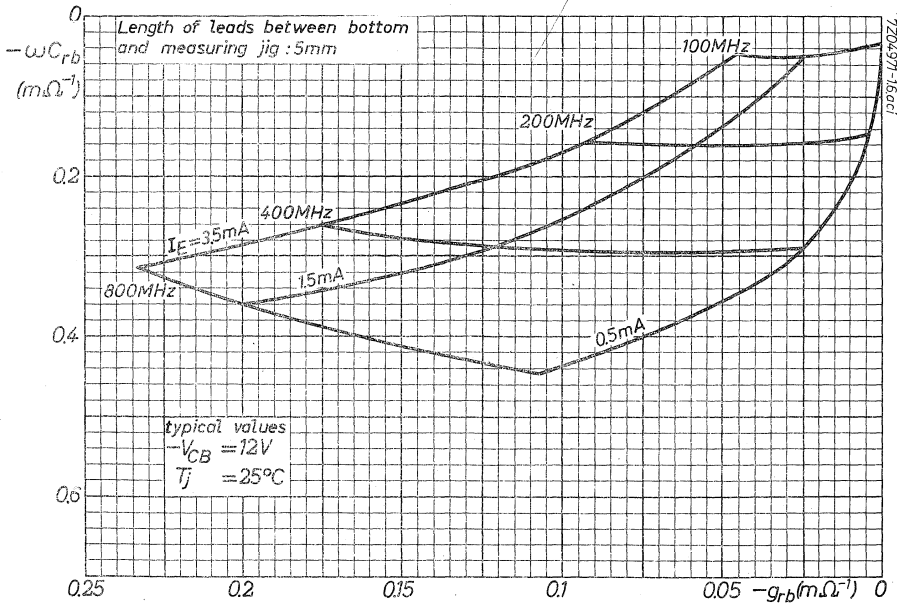

720497-16aci

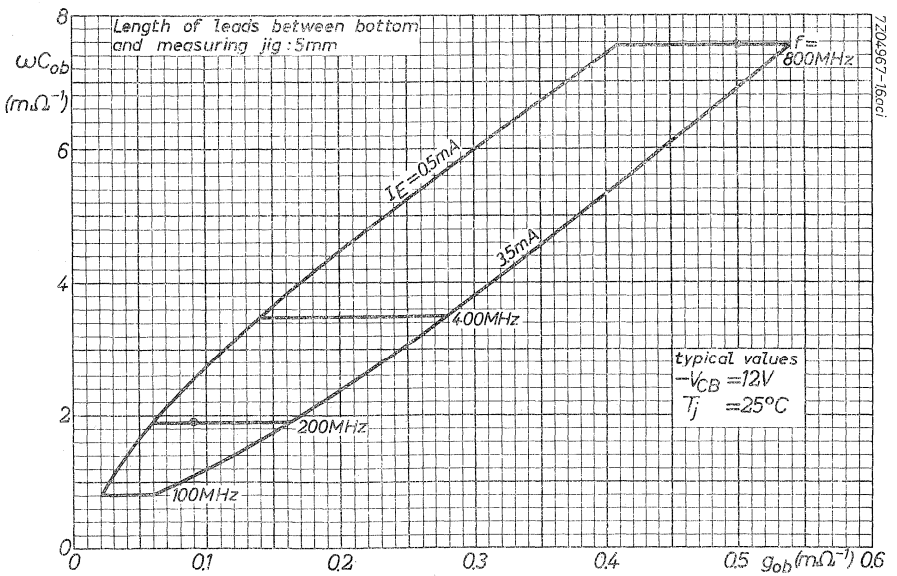
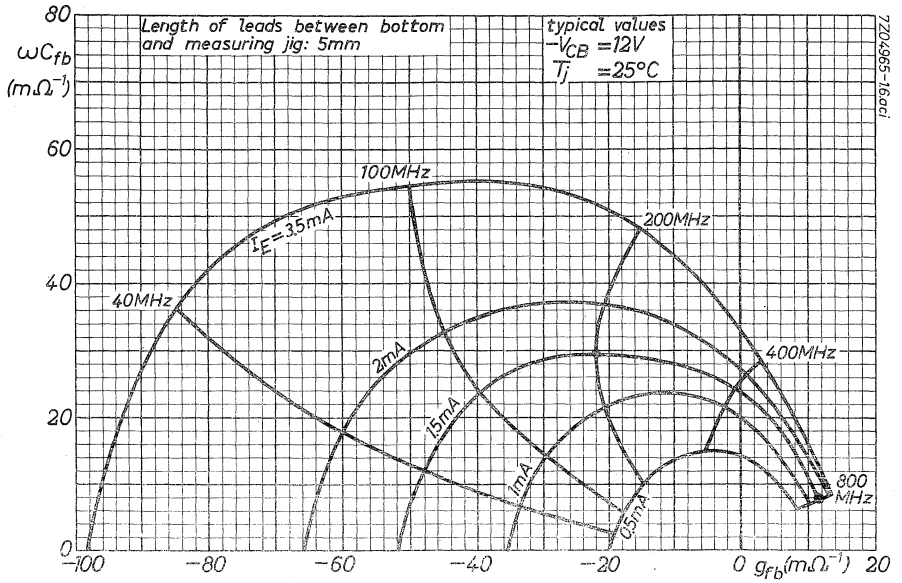

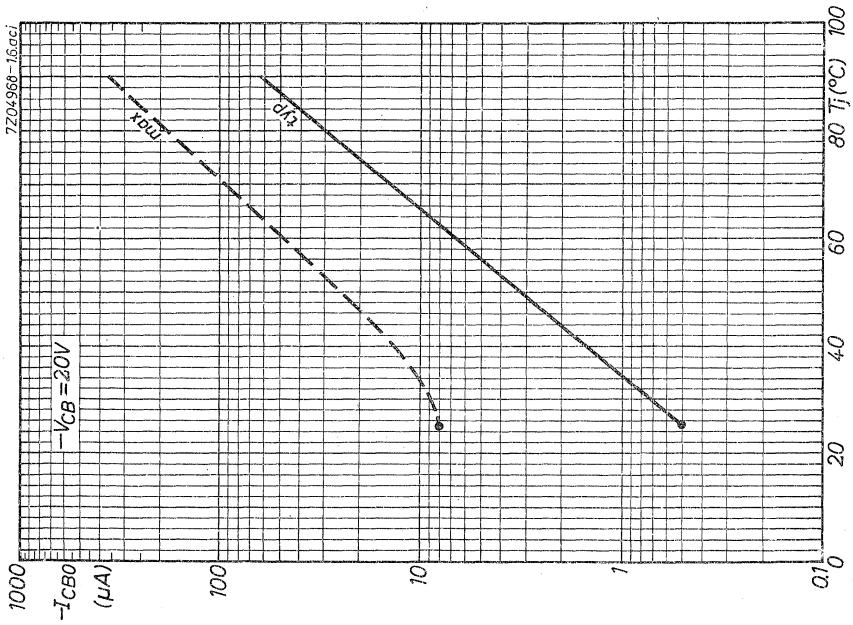
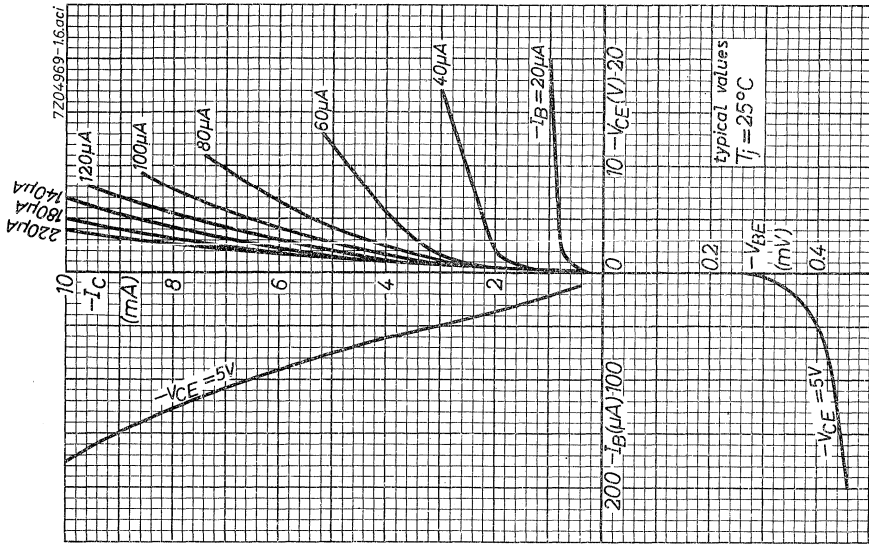

U.H.F GERMANIUM MESA TRANSISTOR

P-N-P transistor in a TO-72 metal envelope, primarily intended for use in pre-amplifier, mixer or oscillator circuits up to frequencies of 890 MHz.

QUICK REFERENCE DATA

| | | | |
|--|----------------------|------|---------------------|
| Collector-base voltage (open emitter) | $-V_{CBO}$ | max. | 20 V |
| Collector-emitter voltage (open base) | $-V_{CEO}$ | max. | 15 V |
| Collector current (d. c.) | $-I_C$ | max. | 15 mA |
| Total power dissipation up to $T_{amb} = 45\text{ }^\circ\text{C}$ | P_{tot} | max. | 60 mW |
| Junction temperature | T_j | max. | 90 $^\circ\text{C}$ |
| Transition frequency | f_T | typ. | 650 MHz |
| $-I_C = 2\text{ mA}; -V_{CE} = 10\text{ V}$ | | | |
| Max. unilateralised power gain | G_{UM} | typ. | 17 dB |
| $I_E = 2\text{ mA}; -V_{CB} = 10\text{ V}; f = 800\text{ MHz}$ | | | |
| Noise figure | | | |
| $I_E = 2\text{ mA}; -V_{CB} = 10\text{ V}$ | | | |
| $G_S = 16.7\text{ m}\Omega^{-1}; B_S = 0$ | | | |
| | $f = 200\text{ MHz}$ | F | typ. 3 dB |
| | $f = 800\text{ MHz}$ | F | typ. 5 dB |

MECHANICAL DATA

Dimensions in mm

TO-72

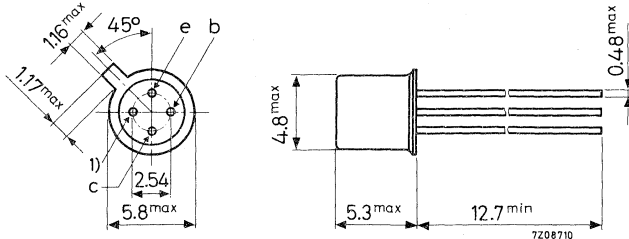

1) = shield lead (connected to case)

Accessories available: 56246, 56263

RATINGS (Limiting values) ¹⁾

Voltages

| | | | | |
|---------------------------------------|------------|------|-----|---|
| Collector-base voltage (open emitter) | $-V_{CBO}$ | max. | 20 | V |
| Collector-emitter voltage (open base) | $-V_{CEO}$ | max. | 15 | V |
| Emitter-base voltage (open collector) | $-V_{EBO}$ | max. | 0.3 | V |

Currents

| | | | | |
|--------------------------------|-----------|------|----|----|
| Collector current (d.c.) | $-I_C$ | max. | 15 | mA |
| Collector current (peak value) | $-I_{CM}$ | max. | 15 | mA |

Power dissipation

| | | | | |
|--|-----------|------|----|----|
| Total power dissipation up to $T_{amb} = 45\text{ }^{\circ}\text{C}$ | P_{tot} | max. | 60 | mW |
|--|-----------|------|----|----|

Temperatures

| | | | |
|----------------------|-----------|------------|-----------------------|
| Storage temperature | T_{stg} | -30 to +75 | $^{\circ}\text{C}$ |
| Junction temperature | T_j | max. | 90 $^{\circ}\text{C}$ |

THERMAL RESISTANCE

| | | | | |
|--------------------------------------|---------------|---|------|------------------------------|
| From junction to ambient in free air | $R_{th\ j-a}$ | = | 0.75 | $^{\circ}\text{C}/\text{mW}$ |
| From junction to case | $R_{th\ j-c}$ | = | 0.40 | $^{\circ}\text{C}/\text{mW}$ |

¹⁾ Limiting values according to the Absolute Maximum System as defined in IEC publication 134.

CHARACTERISTICS

$T_j = 25\text{ }^\circ\text{C}$ unless otherwise specified

Collector cut-off current

$V_{EB} = 0; -V_{CB} = 20\text{ V}$

$-I_{CBS}$ typ. 0.5 μA
 < 8 μA

$I_B = 0; -V_{CE} = 15\text{ V}$

$-I_{CEO}$ < 500 μA

Emitter cut-off current

$I_C = 0; -V_{EB} = 0.3\text{ V}$

$-I_{EBO}$ < 100 μA

Base current

$I_E = 2\text{ mA}; -V_{CB} = 10\text{ V}$

$-I_B$ typ. 60 μA
 < 200 μA

$I_E = 5\text{ mA}; -V_{CB} = 5\text{ V}$

$-I_B$ typ. 167 μA

$I_E = 10\text{ mA}; -V_{CB} = 2\text{ V}$

$-I_B$ < 1 mA

Emitter-base voltage

$I_E = 2\text{ mA}; -V_{CB} = 10\text{ V}$

V_{EB} typ. 350 mV

$I_E = 5\text{ mA}; -V_{CB} = 5\text{ V}$

V_{EB} typ. 400 mV

Transition frequency

$-I_C = 2\text{ mA}; -V_{CE} = 10\text{ V}$

f_T typ. 650 MHz

Feedback capacitance at $f = 1\text{ MHz}$

$-I_C = 2\text{ mA}; -V_{CE} = 10\text{ V}$

C_{re} typ. 230 fF¹⁾

Noise figure

$I_E = 2\text{ mA}; -V_{CB} = 10\text{ V}$

$G_S = 16.7\text{ m}\Omega^{-1}; B_S = 0$

$f = 200\text{ MHz}$

F typ. 3 dB

$f = 800\text{ MHz}$

F typ. 5 dB
 < 6 dB

$f = 900\text{ MHz}$

F typ. 6 dB
 < 7 dB

Maximum unilateralised power gain

$$G_{UM} = \frac{|y_{fb}|^2}{4 g_{ib} g_{ob}}$$

$I_E = 2\text{ mA}; -V_{CB} = 10\text{ V}; f = 800\text{ MHz}$

G_{UM} typ. 17 dB

¹⁾ 1 fF = 1 femtofarad = 10^{-15} F

CHARACTERISTICS (continued)

Transducer gain at $T_{amb} = 25\text{ }^\circ\text{C}$

Basic circuit for measuring the transducer gain G_{tr} at $f = 800$ and 900 MHz.

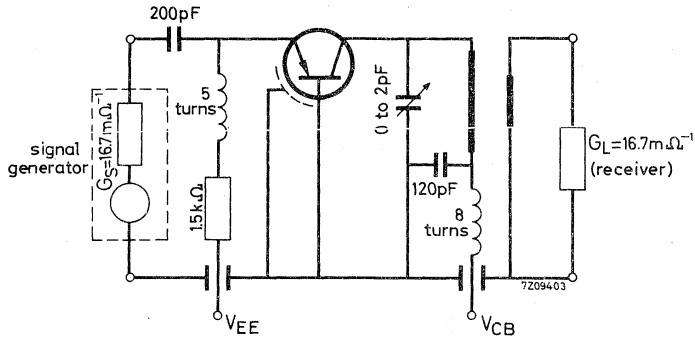

$$G_{tr} = \frac{\text{output power in load } G_L}{\text{available power from source } G_S}$$

$I_E = 2\text{ mA}$; $-V_{CB} = 10\text{ V}$; lead length: 3 mm; can connected to earth.

| | | | | |
|--|----------|------|------|----|
| $f = 50\text{ MHz}$; $G_C = 0.25\text{ m}\Omega^{-1}$ | G_{tr} | typ. | 22.5 | dB |
| $f = 200\text{ MHz}$; $G_C = 0.4\text{ m}\Omega^{-1}$ | G_{tr} | typ. | 21.5 | dB |
| $f = 500\text{ MHz}$; $G_C = 0.5\text{ m}\Omega^{-1}$ | G_{tr} | typ. | 18 | dB |
| $f = 800\text{ MHz}$; $G_C = 0.5\text{ m}\Omega^{-1}$ | G_{tr} | > | 11.5 | dB |
| | | typ. | 14 | dB |
| $G_C = 2\text{ m}\Omega^{-1}$ | G_{tr} | > | 9 | dB |
| | | typ. | 11.5 | dB |
| $f = 900\text{ MHz}$; $G_C = 0.5\text{ m}\Omega^{-1}$ | G_{tr} | typ. | 12.5 | dB |
| $G_C = 2\text{ m}\Omega^{-1}$ | G_{tr} | typ. | 10.5 | dB |

$G_C =$ total effective collector conductance.

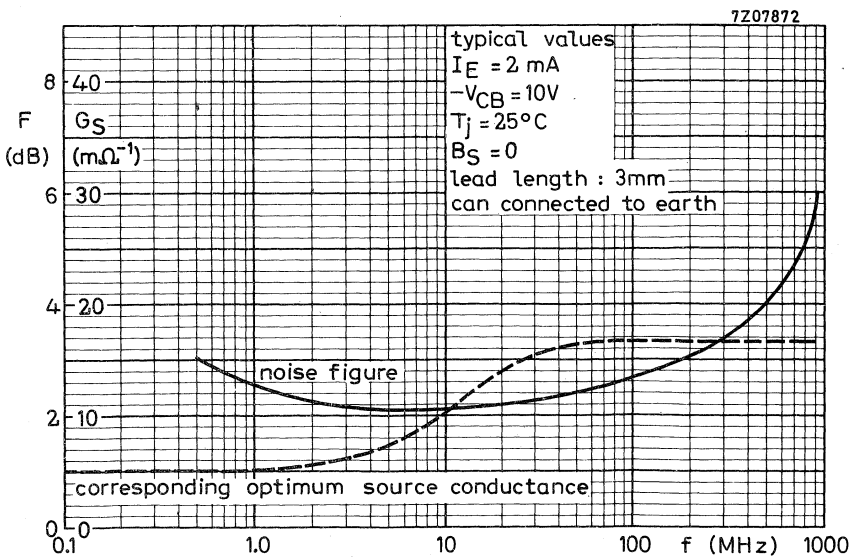
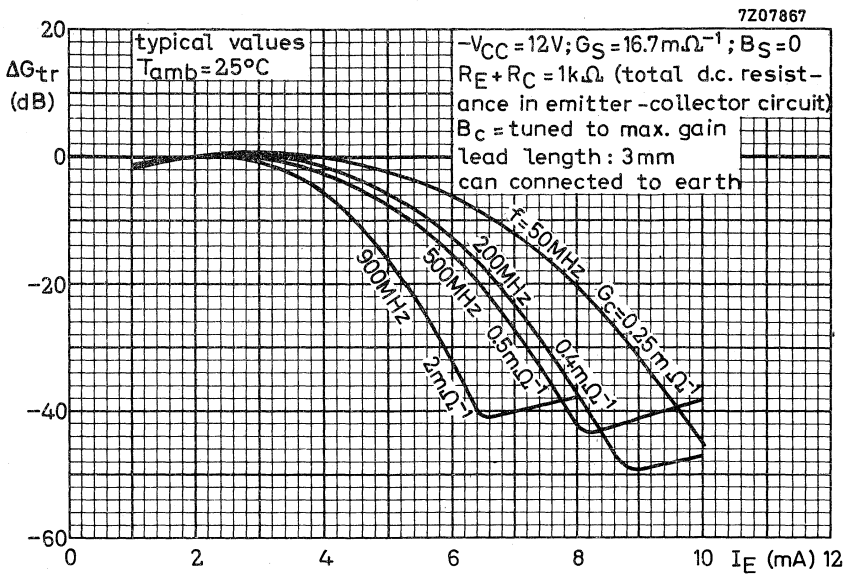

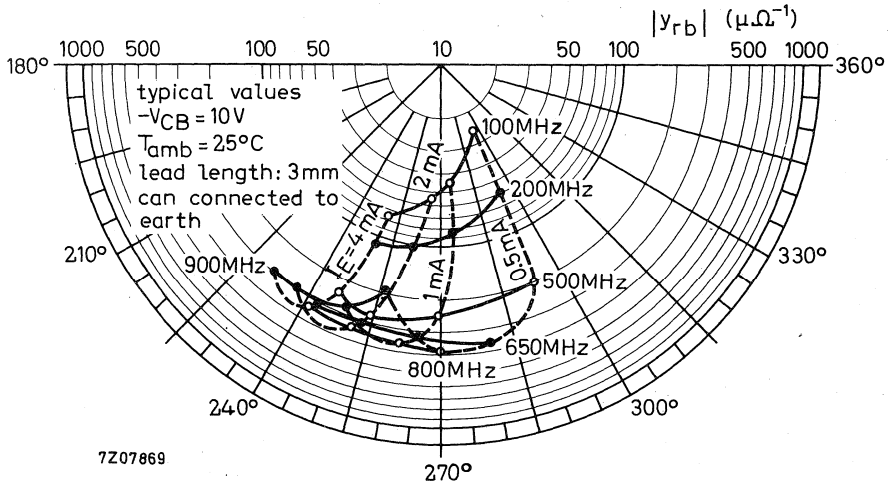
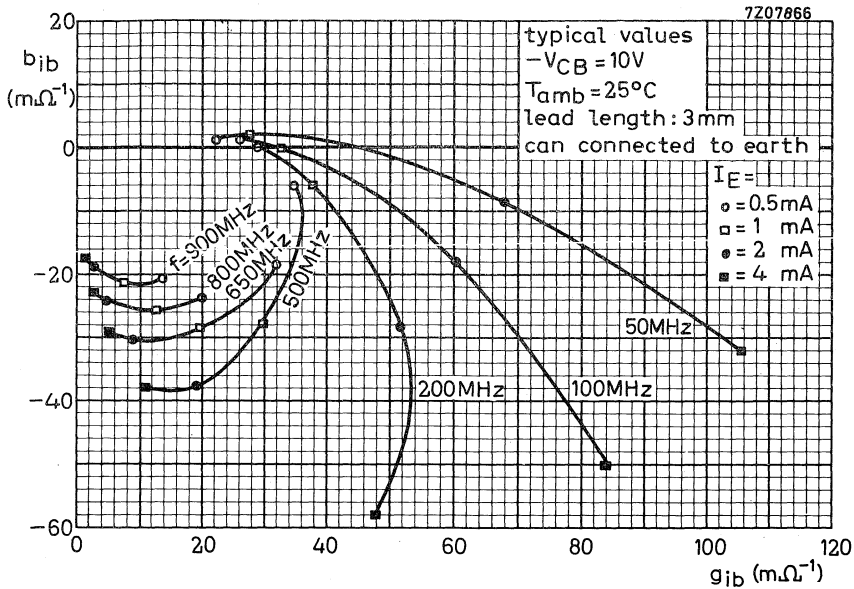

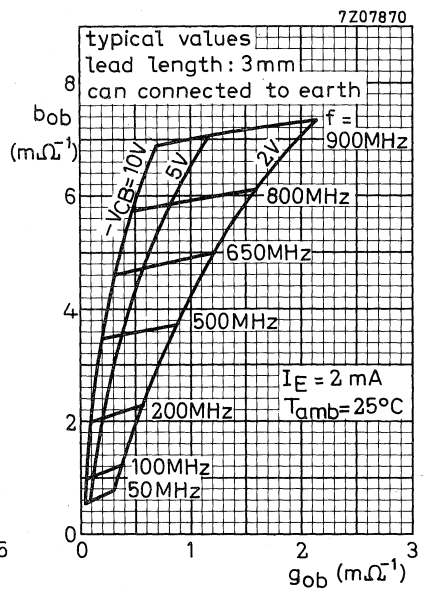
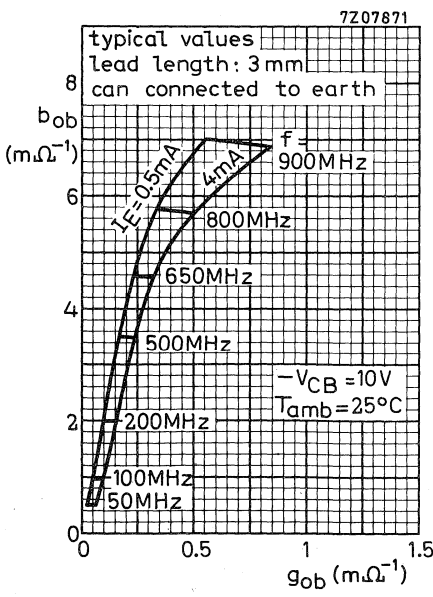
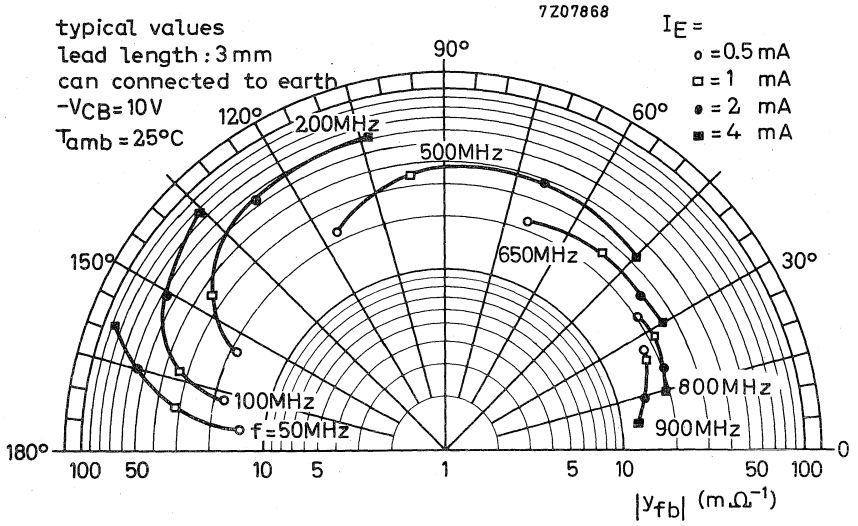

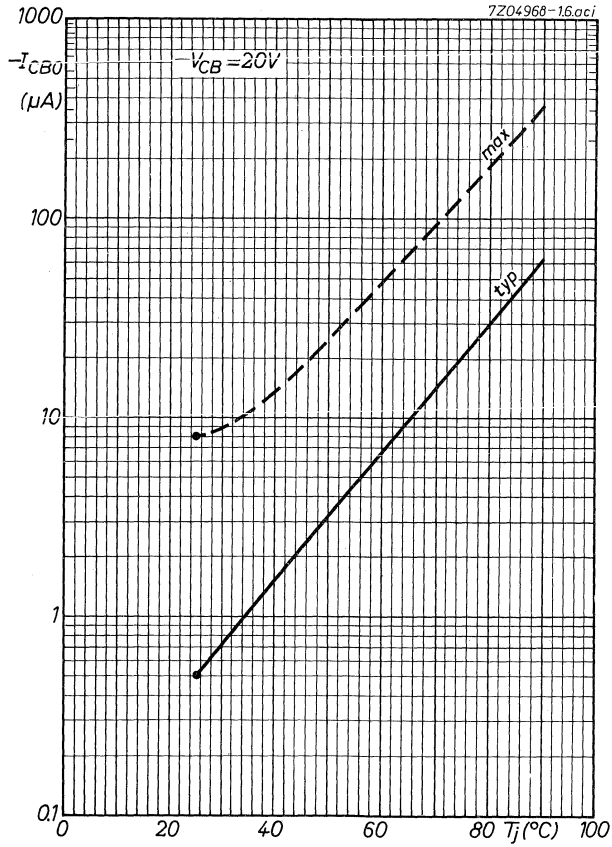

U.H.F. GERMANIUM MESA TRANSISTOR

P-N-P transistor in a TO-72 metal envelope, primarily intended for use in pre-amplifier or mixer circuits up to frequencies of 890 MHz.

QUICK REFERENCE DATA

| | | | |
|--|------------|------|---------------------|
| Collector-base voltage (open emitter) | $-V_{CBO}$ | max. | 20 V |
| Collector-emitter voltage (open base) | $-V_{CEO}$ | max. | 15 V |
| Collector current (d.c.) | $-I_C$ | max. | 15 mA |
| Total power dissipation up to $T_{amb} = 45^\circ\text{C}$ | P_{tot} | max. | 60 mW |
| Junction temperature | T_j | max. | 90 $^\circ\text{C}$ |
| Transition frequency $-I_C = 2 \text{ mA}; -V_{CE} = 10 \text{ V}$ | f_T | typ. | 780 MHz |
| Transducer gain at $I_E = 2 \text{ mA}; -V_{CB} = 10 \text{ V}$ $f = 800 \text{ MHz}; G_C = 0.5 \text{ m}\Omega^{-1}$ | G_{tr} | typ. | 15 dB |
| $f = 900 \text{ MHz}; G_C = 2 \text{ m}\Omega^{-1}$ | G_{tr} | typ. | 12 dB |
| Noise figure $I_E = 2 \text{ mA}; -V_{CB} = 10 \text{ V}$ $G_S = 16.7 \text{ m}\Omega^{-1}; B_S = 0$ | F | < | 5 dB |
| $f = 800 \text{ MHz}$ | F | < | 6 dB |
| $f = 900 \text{ MHz}$ | | | |

MECHANICAL DATA

Dimensions in mm

TO-72

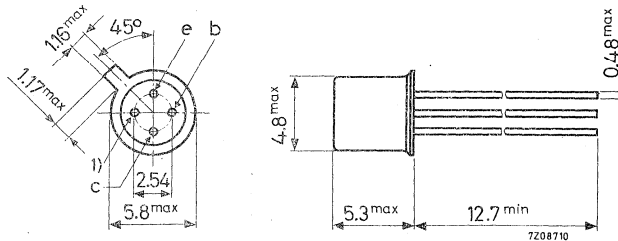

1) = shield lead (connected to case)

Accessories available: 56246, 56263

RATINGS Limiting values in accordance with the Absolute Maximum System (IEC 134)

Voltages

| | | | |
|---------------------------------------|------------|------|-------|
| Collector-base voltage (open emitter) | $-V_{CBO}$ | max. | 20 V |
| Collector-emitter voltage (open base) | $-V_{CEO}$ | max. | 15 V |
| Emitter-base voltage (open collector) | $-V_{EBO}$ | max. | 0.3 V |

Currents

| | | | |
|--------------------------------|-----------|------|-------|
| Collector current (d.c.) | $-I_C$ | max. | 15 mA |
| Collector current (peak value) | $-I_{CM}$ | max. | 15 mA |

Power dissipation

| | | | |
|--|-----------|------|-------|
| Total power dissipation up to $T_{amb} = 45\text{ }^\circ\text{C}$ | P_{tot} | max. | 60 mW |
|--|-----------|------|-------|

Temperatures

| | | | |
|----------------------|-----------|------------|---------------------|
| Storage temperature | T_{stg} | -30 to +75 | $^\circ\text{C}$ |
| Junction temperature | T_j | max. | 90 $^\circ\text{C}$ |

THERMAL RESISTANCE

| | | | |
|--------------------------------------|---------------|---|---------------------------------|
| From junction to ambient in free air | $R_{th\ j-a}$ | = | 0.75 $^\circ\text{C}/\text{mW}$ |
| From junction to case | $R_{th\ j-c}$ | = | 0.40 $^\circ\text{C}/\text{mW}$ |

CHARACTERISTICS

$T_j = 25\text{ }^\circ\text{C}$ unless otherwise specified

Collector cut-off current

$$V_{EB} = 0; -V_{CB} = 20\text{ V}$$

| | | |
|------------|------|-------------------|
| $-I_{CBS}$ | typ. | 0.5 μA |
| | < | 8 μA |

$$I_B = 0; -V_{CE} = 15\text{ V}$$

| | | |
|------------|---|-------------------|
| $-I_{CEO}$ | < | 500 μA |
|------------|---|-------------------|

Emitter cut-off current

$$I_C = 0; -V_{EB} = 0.3\text{ V}$$

| | | |
|------------|---|-------------------|
| $-I_{EBO}$ | < | 100 μA |
|------------|---|-------------------|

Base current

$$I_E = 2\text{ mA}; -V_{CB} = 10\text{ V}$$

| | | |
|--------|------|-------------------|
| $-I_B$ | typ. | 60 μA |
| | < | 200 μA |

$$I_E = 5\text{ mA}; -V_{CB} = 5\text{ V}$$

| | | |
|--------|------|-------------------|
| $-I_B$ | typ. | 167 μA |
|--------|------|-------------------|

$$I_E = 10\text{ mA}; -V_{CB} = 2\text{ V}$$

| | | |
|--------|---|------|
| $-I_B$ | < | 1 mA |
|--------|---|------|

CHARACTERISTICS (continued)

$T_j = 25\text{ }^\circ\text{C}$ unless otherwise specified

Emitter-base voltage

$I_E = 2\text{ mA}; -V_{CB} = 10\text{ V}$ V_{EB} typ. 350 mV

$I_E = 5\text{ mA}; -V_{CB} = 5\text{ V}$ V_{EB} typ. 400 mV

Transition frequency

$-I_C = 2\text{ mA}; -V_{CE} = 10\text{ V}$ f_T typ. 780 MHz

Feedback capacitance at $f = 1\text{ MHz}$

$-I_C = 2\text{ mA}; -V_{CE} = 10\text{ V}$ C_{re} typ. 200 fF

Noise figure

$I_E = 2\text{ mA}; -V_{CB} = 10\text{ V}$

$G_S = 16.7\text{ m}\Omega^{-1}; B_S = 0$

$f = 800\text{ MHz}$ $F < 5\text{ dB}$

$f = 900\text{ MHz}$ $F < 6\text{ dB}$

Transducer gain at $T_{amb} = 25\text{ }^\circ\text{C}$

Basic circuit for measuring the transducer gain G_{tr} at $f = 800$ and 900 MHz .

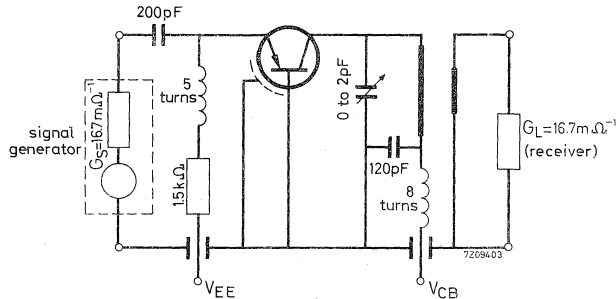

$$G_{tr} \text{ in dB} = 10 \log \frac{\text{output power in load } G_L}{\text{available power from source } G_S}$$

$I_E = 2\text{ mA}; -V_{CB} = 10\text{ V};$ lead length: 3 mm; can connected to earth.

$f = 800\text{ MHz}; G_C = 0.5\text{ m}\Omega^{-1}$
 $G_C = 2\text{ m}\Omega^{-1}$

G_{tr} typ. 15 dB

G_{tr} typ. 12.5 dB

$f = 900\text{ MHz}; G_C = 2\text{ m}\Omega^{-1}$

$G_{tr} > 11\text{ dB}$

typ. 12 dB

$G_C =$ total effective collector conductance.

000000

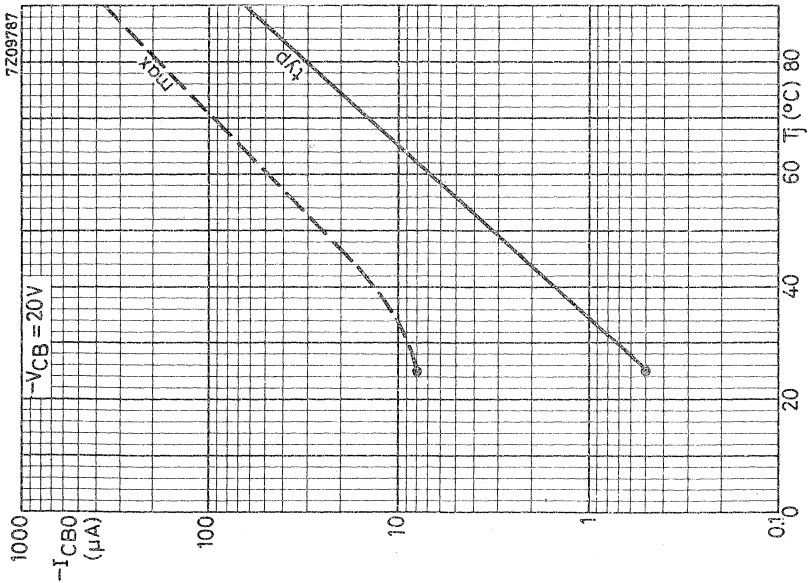
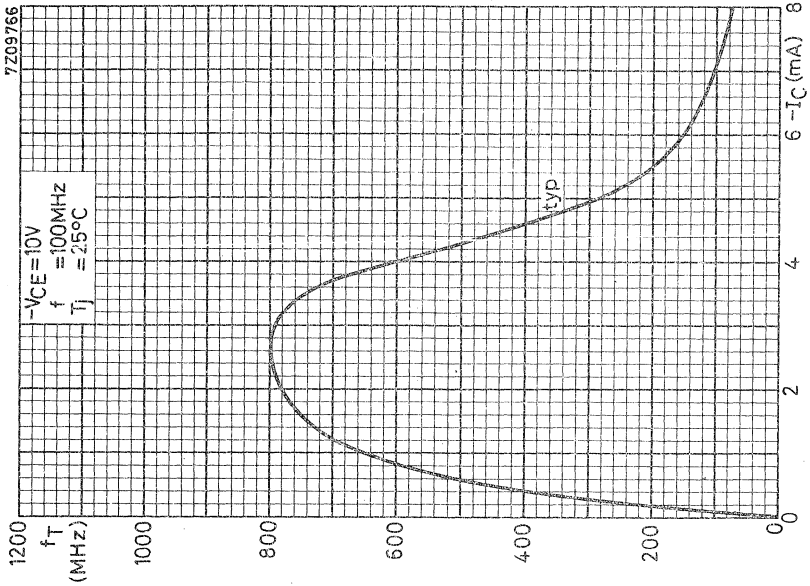

U.H.F. GERMANIUM PLANAR TRANSISTOR

P-N-P transistors in a plastic T-pack, primarily intended for use in pre-amplifier circuits with frequencies up to 890 MHz.

| QUICK REFERENCE DATA | | | | |
|---|------------|------|-----|------------------|
| Collector-base voltage ($V_{EB} = 0$) | $-V_{CBS}$ | max. | 20 | V |
| Collector-emitter voltage (open base) | $-V_{CEO}$ | max. | 15 | V |
| Collector current (d. c.) | $-I_C$ | max. | 10 | mA |
| Total power dissipation up to $T_{amb} = 54^\circ\text{C}$ | P_{tot} | max. | 60 | mW |
| Junction temperature | T_j | max. | 90 | $^\circ\text{C}$ |
| Transition frequency | | | | |
| $I_E = 2\text{ mA}; -V_{CB} = 10\text{ V}$ | f_T | typ. | 800 | MHz |
| Transducer gain | | | | |
| $I_E = 2\text{ mA}; -V_{CB} = 10\text{ V}; f = 900\text{ MHz}$ | G_{tr} | typ. | 12 | dB |
| Noise figure | | | | |
| $I_E = 2\text{ mA}; -V_{CB} = 10\text{ V}$ $G_S = 16,7\text{ mA/V}; B_S = 0$ $f = 900\text{ MHz}$ | F | < | 6 | dB |

MECHANICAL DATA

Dimensions in mm

SOT-37

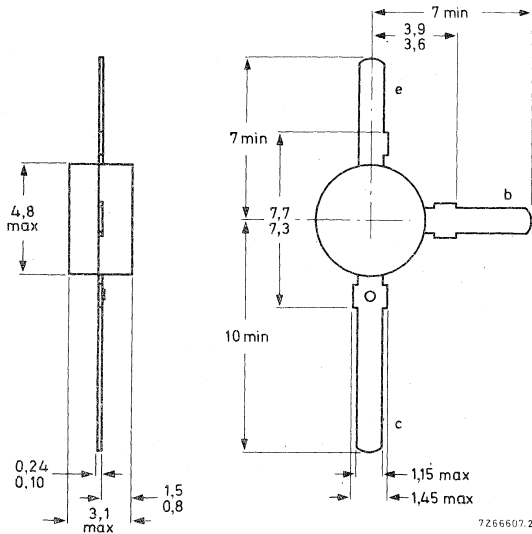

RATINGS Limiting values in accordance with the Absolute Maximum System (IEC 134)

Voltages

| | | | |
|--|------------|------|-------|
| Collector-base voltage ($-V_{EB} = 0$) | $-V_{CBS}$ | max. | 20 V |
| Collector-emitter voltage (open base) | $-V_{CEO}$ | max. | 15 V |
| Emitter-base voltage (open collector) | $-V_{EBO}$ | max. | 0,3 V |

Currents

| | | | |
|--------------------------|--------|------|-------|
| Collector current (d.c.) | $-I_C$ | max. | 10 mA |
| Base current | $-I_B$ | max. | 1 mA |

Power dissipation

| | | | |
|--|-----------|------|-------|
| Total power dissipation up to $T_{amb} = 54\text{ }^{\circ}\text{C}$ | P_{tot} | max. | 60 mW |
|--|-----------|------|-------|

Temperatures

| | | | |
|----------------------|-----------|------------|-----------------------|
| Storage temperature | T_{stg} | -30 to +75 | $^{\circ}\text{C}$ |
| Junction temperature | T_j | max. | 90 $^{\circ}\text{C}$ |

THERMAL RESISTANCE

| | | | |
|--------------------------------------|---------------|---|----------------------------------|
| From junction to ambient in free air | $R_{th\ j-a}$ | = | 0,6 $^{\circ}\text{C}/\text{mW}$ |
|--------------------------------------|---------------|---|----------------------------------|



CHARACTERISTICS

 $T_j = 25\text{ }^\circ\text{C}$ unless otherwise specifiedCollector cut-off current

$V_{EB} = 0; -V_{CB} = 20\text{ V}$

| | | | |
|------------|------|----|---------------|
| $-I_{CBS}$ | typ. | 2 | μA |
| | < | 15 | μA |

$I_B = 0; -V_{CE} = 15\text{ V}$

| | | | |
|------------|---|-----|---------------|
| $-I_{CEO}$ | < | 500 | μA |
|------------|---|-----|---------------|

Emitter cut-off current

$I_C = 0; -V_{EB} = 0, 3\text{ V}$

| | | | |
|------------|---|-----|---------------|
| $-I_{EBO}$ | < | 100 | μA |
|------------|---|-----|---------------|

Base current

$I_E = 2\text{ mA}; -V_{CB} = 10\text{ V}$

| | | | |
|--------|---|-----|---------------|
| $-I_B$ | < | 200 | μA |
|--------|---|-----|---------------|

$I_E = 10\text{ mA}; -V_{CB} = 2\text{ V}$

| | | | |
|--------|---|---|----|
| $-I_B$ | < | 1 | mA |
|--------|---|---|----|

Emitter-base voltage

$I_E = 2\text{ mA}; -V_{CB} = 10\text{ V}$

| | | | |
|----------|------|-----|----|
| V_{EB} | typ. | 350 | mV |
|----------|------|-----|----|

Transition frequency at $f = 100\text{ MHz}$

$I_E = 2\text{ mA}; -V_{CB} = 10\text{ V}$

| | | | |
|-------|------|-----|-----|
| f_T | typ. | 800 | MHz |
|-------|------|-----|-----|

Feedback capacitance at $f = 0, 45\text{ MHz}$

$I_E = 2\text{ mA}; -V_{CB} = 10\text{ V}$

| | | | |
|----------|------|------|----|
| C_{re} | typ. | 0, 4 | pF |
|----------|------|------|----|

Noise figure at $f = 900\text{ MHz}$

$I_E = 2\text{ mA}; -V_{CB} = 10\text{ V};$

$G_S = 16, 7\text{ mA/V}; B_S = 0$

| | | | |
|---|---|---|----|
| F | < | 6 | dB |
|---|---|---|----|

Transducer gain at $f = 900\text{ MHz}$ (common base)

$$G_{tr} \text{ (in dB)} = 10 \log \frac{\text{output power in load } G_L}{\text{available power from source } G_S}$$

$I_E = 2\text{ mA}; -V_{CB} = 10\text{ V}; T_{amb} = 25\text{ }^\circ\text{C}$

$G_S = 16, 7\text{ mA/V}; G_L = 2\text{ mA/V}$

| | | | |
|----------|------|-------|----|
| G_{tr} | > | 10, 5 | dB |
| | typ. | 12 | dB |

CHARACTERISTICS (continued)

y parameters (common base) at $f = 900 \text{ MHz}$

$I_E = 2 \text{ mA}$; $-V_{CB} = 10 \text{ V}$

| | | | | |
|--|----------------|------|--------------|---------------|
| Input admittance | y_{ib} | typ. | $18 - j27$ | mA/V |
| Feedback admittance | $ y_{rb} $ | typ. | 0,6 | mA/V |
| Phase angle of the feedback admittance | φ_{rb} | typ. | 270° | |
| Transfer admittance | $ y_{fb} $ | typ. | 26 | mA/V |
| Phase angle of the transfer admittance | φ_{fb} | typ. | 55° | |
| Output admittance | y_{ob} | typ. | $0,5 + j3,5$ | mA/V |

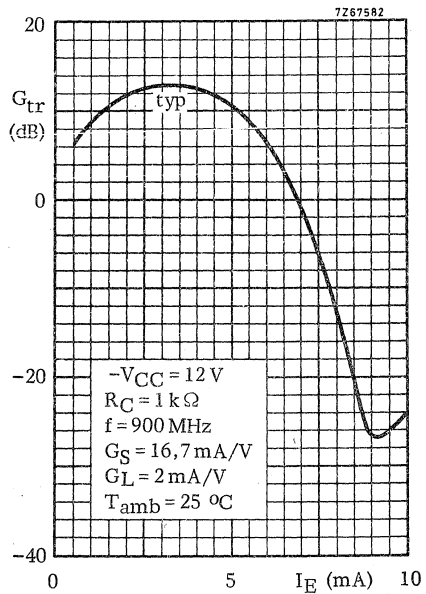
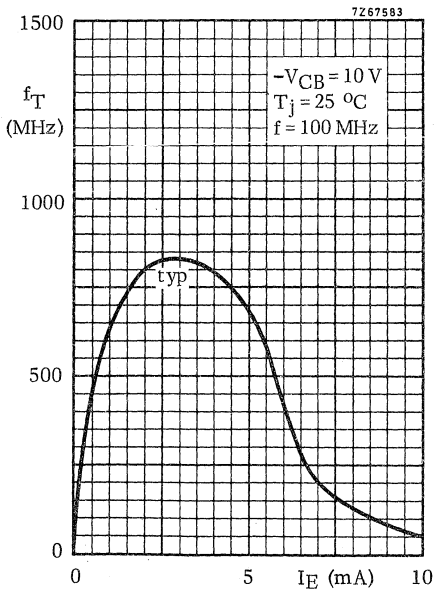

U.H.F. GERMANIUM PLANAR TRANSISTOR

P-N-P transistors in a plastic T-pack, intended for use in mixer and oscillator circuits with frequencies up to 890 MHz.

| QUICK REFERENCE DATA | | | | |
|---|------------|------|------|--------------------|
| Collector-base voltage ($V_{EB} = 0$) | $-V_{CBS}$ | max. | 20 | V |
| Collector-emitter voltage (open base) | $-V_{CEO}$ | max. | 15 | V |
| Collector current (d. c.) | $-I_C$ | max. | 10 | mA |
| Total power dissipation up to $T_{amb} = 54\text{ }^{\circ}\text{C}$ | P_{tot} | max. | 60 | mW |
| Junction temperature | T_j | max. | 90 | $^{\circ}\text{C}$ |
| Transition frequency | f_T | typ. | 550 | MHz |
| $I_E = 2\text{ mA}; -V_{CE} = 10\text{ V}$ | | | | |
| Transducer gain | G_{tr} | typ. | 10,5 | dB |
| $I_E = 2\text{ mA}; -V_{CE} = 10\text{ V}; f = 900\text{ MHz}$ | | | | |
| Noise figure | F | typ. | 6,5 | dB |
| $I_E = 2\text{ mA}; -V_{CE} = 10\text{ V}$ $G_S = 16,7\text{ mA/V}; B_S = 0$ $f = 900\text{ MHz}$ | | | | |

MECHANICAL DATA

SOT-37

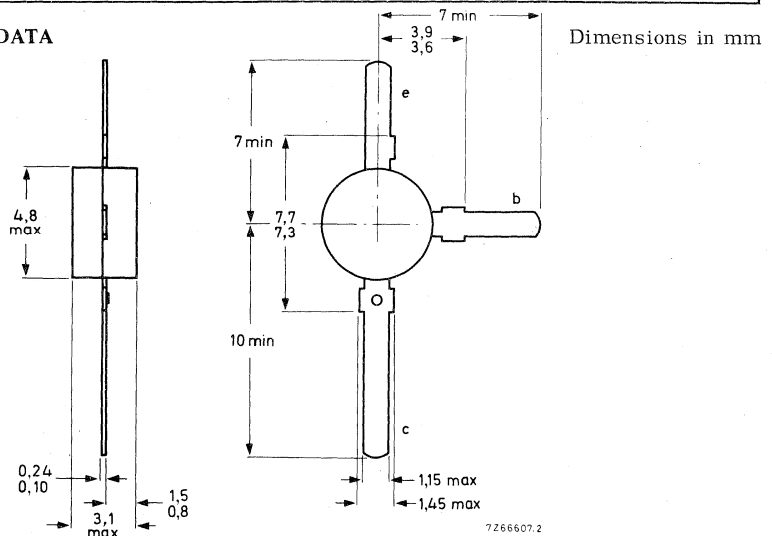

7266607.2

RATINGS Limiting values in accordance with the Absolute Maximum System (IEC134)

Voltages

| | | | | |
|---|------------|------|-----|---|
| Collector-base voltage ($V_{BE} = 0$) | $-V_{CBS}$ | max. | 20 | V |
| Collector-emitter voltage (open base) | $-V_{CEO}$ | max. | 15 | V |
| Emitter-base voltage (open collector) | $-V_{EBO}$ | max. | 0,3 | V |

Currents

| | | | | |
|--------------------------|--------|------|----|----|
| Collector current (d.c.) | $-I_C$ | max. | 10 | mA |
|--------------------------|--------|------|----|----|

Power dissipation

| | | | | |
|--|-----------|------|----|----|
| Total power dissipation up to $T_{amb} = 54\text{ }^\circ\text{C}$ | P_{tot} | max. | 60 | mW |
|--|-----------|------|----|----|

Temperatures

| | | | |
|----------------------|-----------|------------|------------------|
| Storage temperature | T_{stg} | -30 to +75 | $^\circ\text{C}$ |
| Junction temperature | T_j | max. 90 | $^\circ\text{C}$ |

THERMAL RESISTANCE

| | | | | |
|--------------------------------------|---------------|---|-----|----------------------------|
| From junction to ambient in free air | $R_{th\ j-a}$ | = | 0,6 | $^\circ\text{C}/\text{mW}$ |
|--------------------------------------|---------------|---|-----|----------------------------|

CHARACTERISTICS

$T_j = 25\text{ }^\circ\text{C}$ unless otherwise specified

Collector cut-off current

| | | | | |
|-------------------------------------|------------|------|-----|---------------|
| $V_{EB} = 0; -V_{CB} = 20\text{ V}$ | $-I_{CBS}$ | typ. | 0,8 | μA |
| | | < | 15 | μA |
| $I_B = 0; -V_{CE} = 15\text{ V}$ | $-I_{CEO}$ | < | 500 | μA |

Emitter cut-off current

| | | | | |
|-----------------------------------|------------|---|-----|---------------|
| $I_C = 0; -V_{EB} = 0,3\text{ V}$ | $-I_{EBO}$ | < | 100 | μA |
|-----------------------------------|------------|---|-----|---------------|

D. C. current gain

| | | | |
|---|----------|---|----|
| $-I_C = 2\text{ mA}; -V_{CE} = 10\text{ V}$ | h_{FE} | > | 10 |
| $-I_C = 10\text{ mA}; -V_{CE} = 1\text{ V}$ | h_{FE} | > | 10 |

CHARACTERISTICS (continued)

$T_j = 25\text{ }^\circ\text{C}$ unless otherwise specified

Base-emitter voltage

$-I_C = 2\text{ mA}; -V_{CE} = 10\text{ V}$ $-V_{BE}$ typ. 370 mV

Transition frequency at $f = 100\text{ MHz}$

$-I_C = 2\text{ mA}; -V_{CE} = 10\text{ V}$ f_T typ. 550 MHz

Feedback capacitance at $f = 450\text{ kHz}$

$-I_C = 2\text{ mA}; -V_{CE} = 10\text{ V}$ C_{re} typ. 400 fF

Output capacitance at $f = 800\text{ MHz}$

$-I_C = 2\text{ mA}; -V_{CE} = 10\text{ V}$ C_{ob} typ. 500 fF

Noise figure at $f = 900\text{ MHz}$

$-I_C = 2\text{ mA}; -V_{CE} = 10\text{ V}$
 $G_S = 16,7\text{ mA/V}; B_S = 0$ F typ. 6,5 dB

Transducer gain at $f = 900\text{ MHz}$ (common base)

$$G_{tr} \text{ (in dB)} = 10 \log \frac{\text{output power in load } G_L}{\text{available power from source } G_S}$$

$-I_C = 2\text{ mA}; -V_{CE} = 10\text{ V}; T_{amb} = 25\text{ }^\circ\text{C}$
 $G_L = 2\text{ mA/V}; G_S = 16,7\text{ mA/V}$ G_{tr} > 9 dB
 typ. 10,5 dB

.....

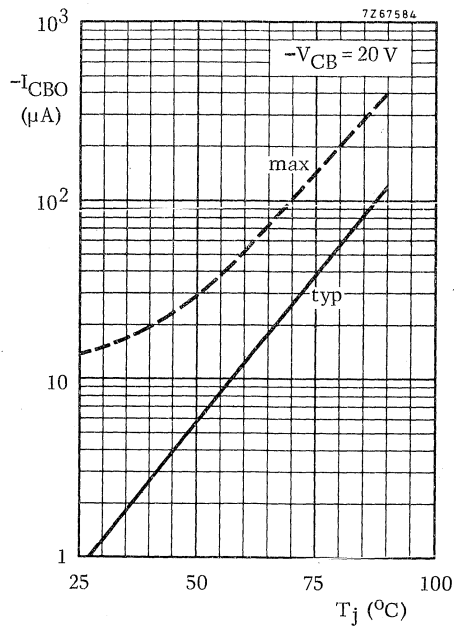

.....

SILICON PLANAR EPITAXIAL TRANSISTOR

N-P-N transistor in TO-72 metal case with insulated electrodes and a shield lead connected to the case; the same transistor is available in lock-fit encapsulation under the type number BF194 or BF195. It is intended for general broadcast and television.

QUICK REFERENCE DATA

| | | | |
|--|-----------|------|----------------------|
| Collector-base voltage (open emitter) | V_{CBO} | max. | 50 V |
| Collector-emitter voltage (open base) | V_{CEO} | max. | 30 V |
| Collector current (d. c.) | I_C | max. | 30 mA |
| Total power dissipation up to $T_{amb} = 45^\circ\text{C}$ | P_{tot} | max. | 145 mW |
| Junction temperature | T_j | max. | 175 $^\circ\text{C}$ |
| Transition frequency | f_T | typ. | 230 MHz |
| $I_C = 1 \text{ mA}; V_{CE} = 10 \text{ V}$ | | | |
| Noise figure | F | typ. | 1.2 dB |
| $I_C = 1 \text{ mA}; V_{CE} = 10 \text{ V}$ | | | |
| $f = 1 \text{ MHz}; G_S = 3.3 \text{ m}\Omega^{-1}$ | F | typ. | 1.2 dB |
| $f = 100 \text{ MHz}; G_S = 10 \text{ m}\Omega^{-1}$ | F | typ. | 4 dB |

MECHANICAL DATA

Dimensions in mm

TO-72

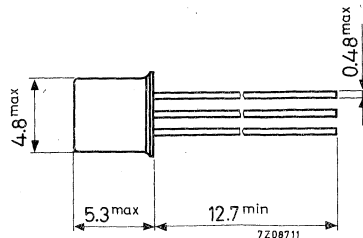
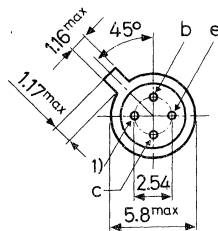

1) = shield lead (connected to case)

Accessories available: 56246, 56263.

FOR NEW DESIGN THE SUCCESSOR TYPES
BF494 OR BF495 ARE RECOMMENDED

RATINGS (Limiting values) ¹⁾

Voltages

| | | | |
|--|-----------|------|------|
| Collector-base voltage (open emitter) | V_{CBO} | max. | 50 V |
| Collector-emitter voltage (open base) (See also page 5) | V_{CEO} | max. | 30 V |
| Collector-emitter voltage (see page 5) | V_{CER} | max. | 50 V |
| Emitter-base voltage (open collector) | V_{EBO} | max. | 5 V |

Currents

| | | | |
|--------------------------------|----------|------|-------|
| Collector current (d. c.) | I_C | max. | 30 mA |
| Collector current (peak value) | I_{CM} | max. | 30 mA |

Power dissipation

| | | | |
|--|-----------|------|--------|
| Total power dissipation up to $T_{amb} = 45\text{ }^\circ\text{C}$ | P_{tot} | max. | 145 mW |
|--|-----------|------|--------|

Temperatures

| | | | |
|----------------------|-----------|-------------|----------------------|
| Storage temperature | T_{stg} | -65 to +175 | $^\circ\text{C}$ |
| Junction temperature | T_j | max. | 175 $^\circ\text{C}$ |

THERMAL RESISTANCE

| | | | |
|--------------------------------------|---------------|---|--------------------------------|
| From junction to ambient in free air | $R_{th\ j-a}$ | = | 0.9 $^\circ\text{C}/\text{mW}$ |
|--------------------------------------|---------------|---|--------------------------------|

¹⁾ Limiting values according to the Absolute Maximum System as defined in IEC publication 134.

CHARACTERISTICS

$T_j = 25\text{ }^\circ\text{C}$ unless otherwise specified

Emitter-base voltage ¹⁾

| | | | |
|---|-----------|--------------|-------|
| $-I_E = 1\text{ mA}; V_{CB} = 10\text{ V}$ | $-V_{EB}$ | 0.65 to 0.74 | V |
| $-I_E = 20\text{ mA}; V_{CB} = 2\text{ V}; T_{\text{amb}} = 25\text{ }^\circ\text{C}$ | $-V_{EB}$ | < | 1.0 V |

Feedback capacitance at $f = 0.45\text{ MHz}$

| | | | |
|---|----------|------|---------|
| $I_C = 1\text{ mA}; V_{CE} = 10\text{ V}$ | C_{re} | typ. | 0.65 pF |
|---|----------|------|---------|

D.C. current gain

| | | | |
|---|----------|-------|-----|
| $I_C = 1\text{ mA}; V_{CE} = 10\text{ V}$ | h_{FE} | 45 to | 165 |
| $I_C = 20\text{ mA}; V_{CE} = 2\text{ V}$ | h_{FE} | > | 40 |

Transition frequency

| | | | |
|---|-------|------|---------|
| $I_C = 1\text{ mA}; V_{CE} = 10\text{ V}$ | f_T | typ. | 230 MHz |
|---|-------|------|---------|

Noise figure at $I_C = 1\text{ mA}; V_{CE} = 10\text{ V}$

| | | | |
|---|---|------|--------|
| $f = 0.2\text{ MHz}; G_S = 3.3\text{ m}\Omega^{-1}$ | F | typ. | 1.5 dB |
| $f = 1\text{ MHz}; G_S = 20\text{ m}\Omega^{-1}$ | F | typ. | 3.5 dB |
| $f = 1\text{ MHz}; G_S = 3.3\text{ m}\Omega^{-1}$ | F | typ. | 1.2 dB |
| $f = 100\text{ MHz}; G_S = 10\text{ m}\Omega^{-1}$ | F | typ. | 4 dB |

Conversion noise figure at $I_C = 1\text{ mA}; V_{CE} = 10\text{ V}$

| | | | |
|---|-------|------|--------|
| $f = 0.2\text{ MHz}; G_S = 1\text{ m}\Omega^{-1}$ | F_c | typ. | 3.5 dB |
| $f = 1\text{ MHz}; G_S = 2\text{ m}\Omega^{-1}$ | F_c | typ. | 2.5 dB |

¹⁾ $-V_{EB}$ decreases by about $1.7\text{ mV}/^\circ\text{C}$ with increasing temperature.

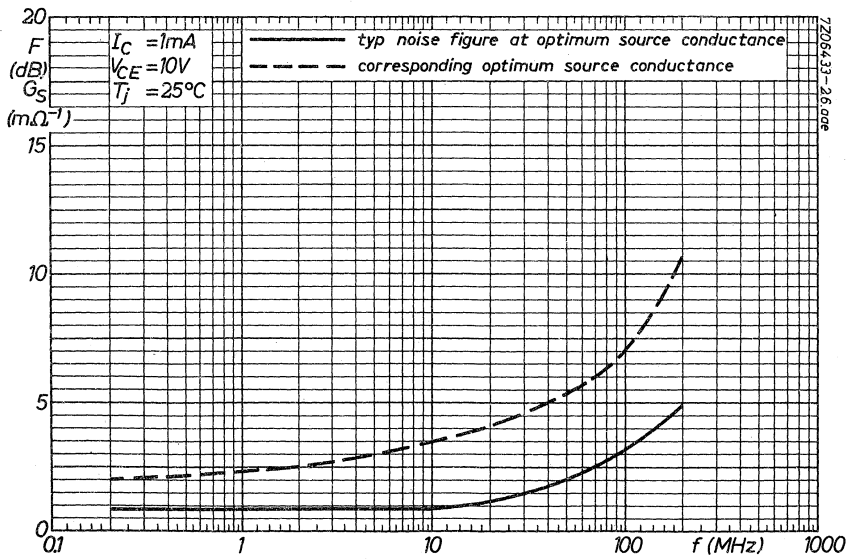
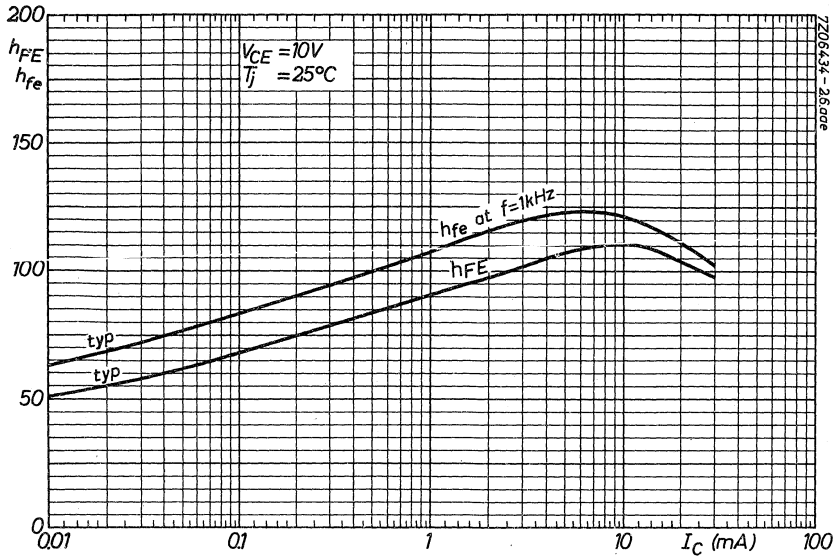

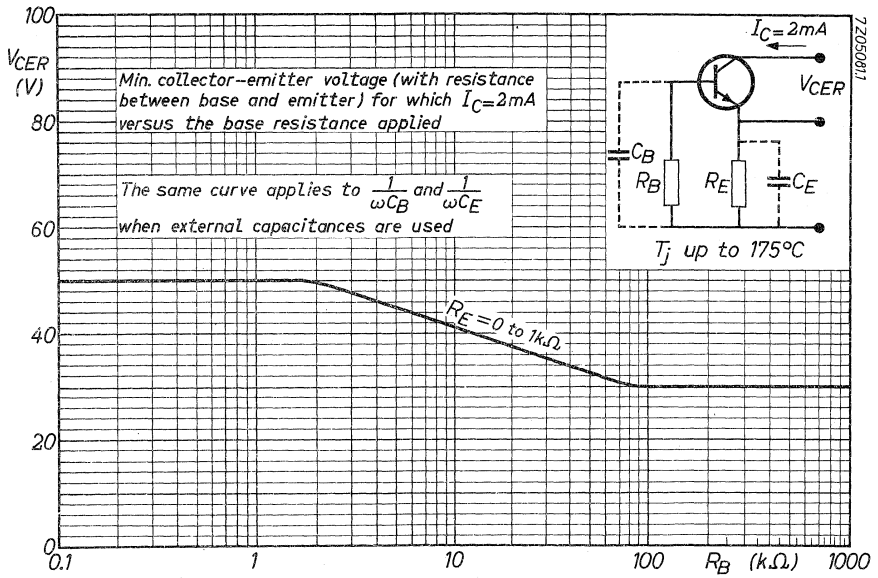

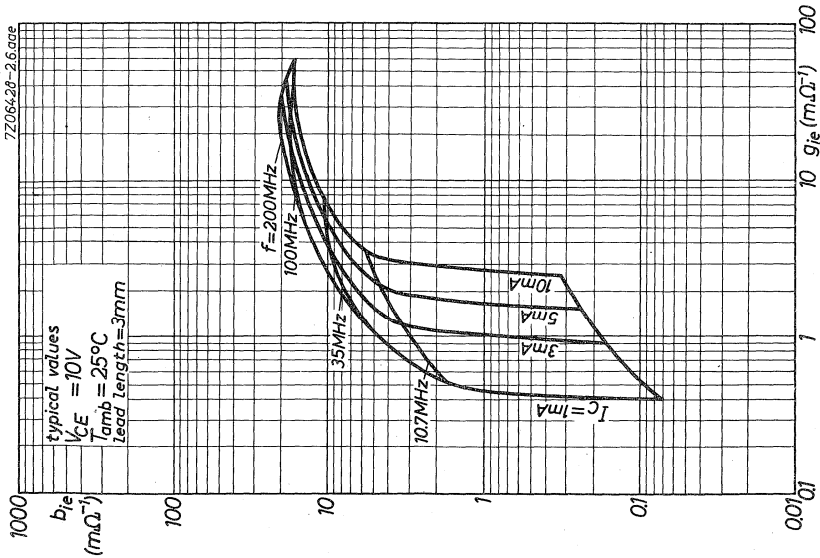
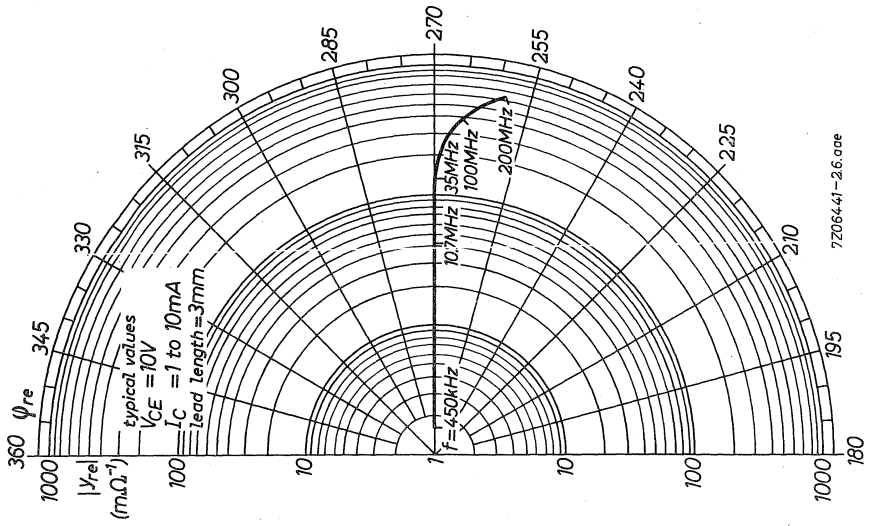

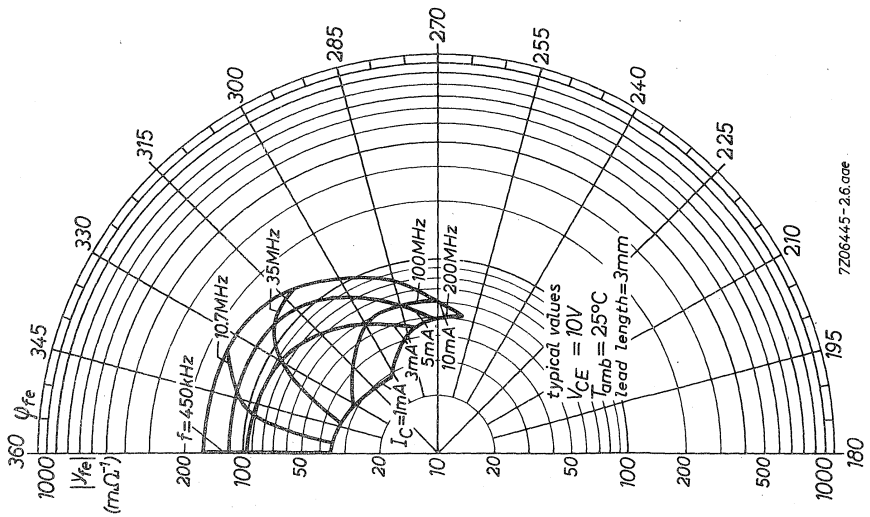
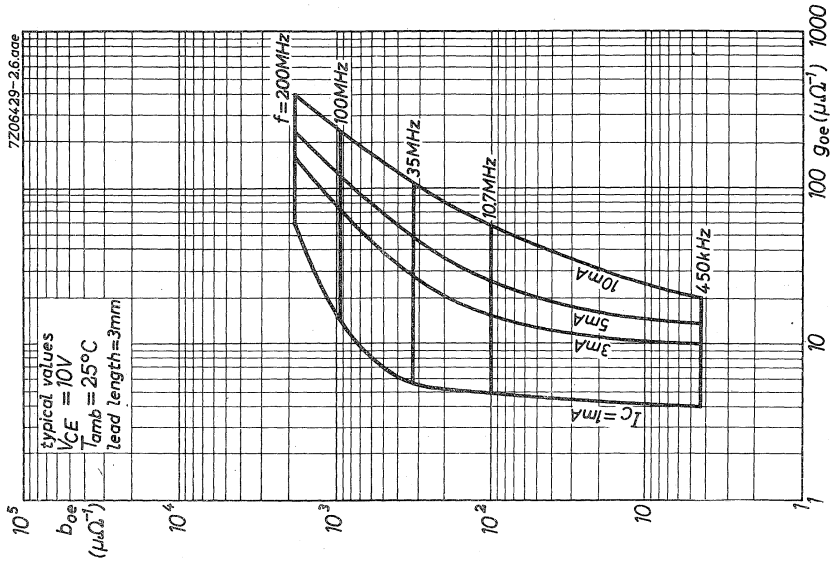

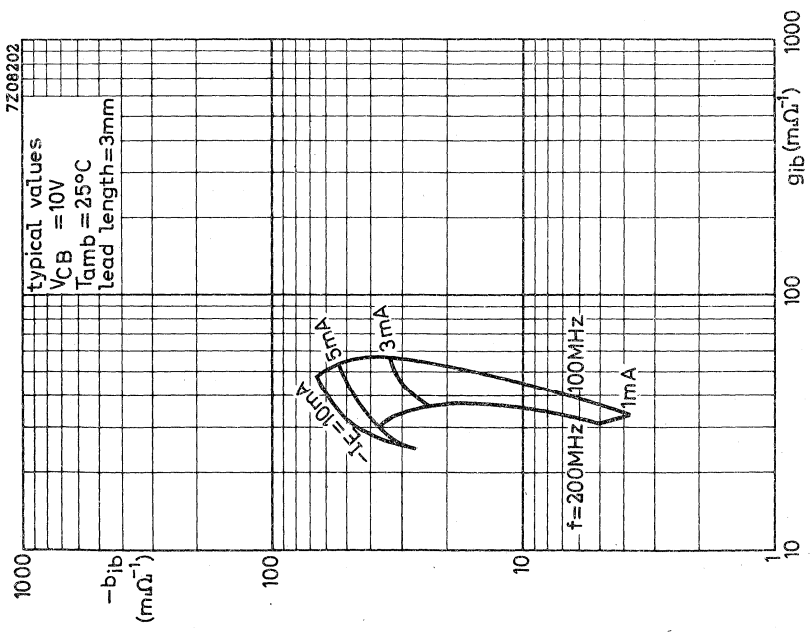
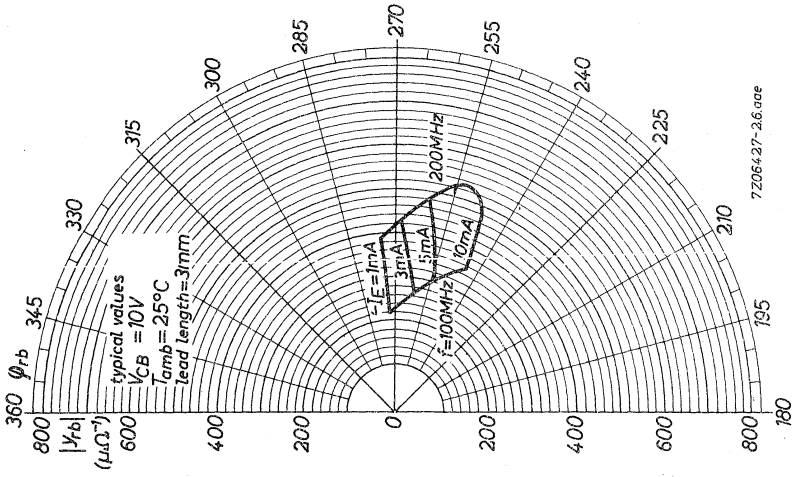

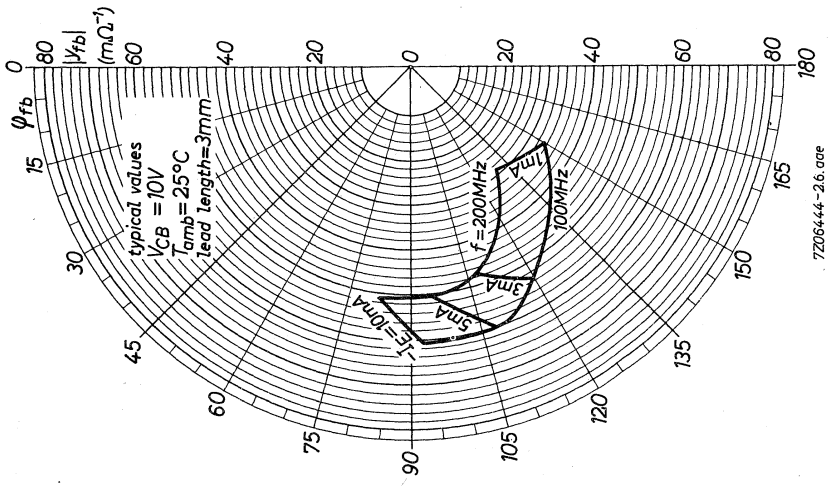
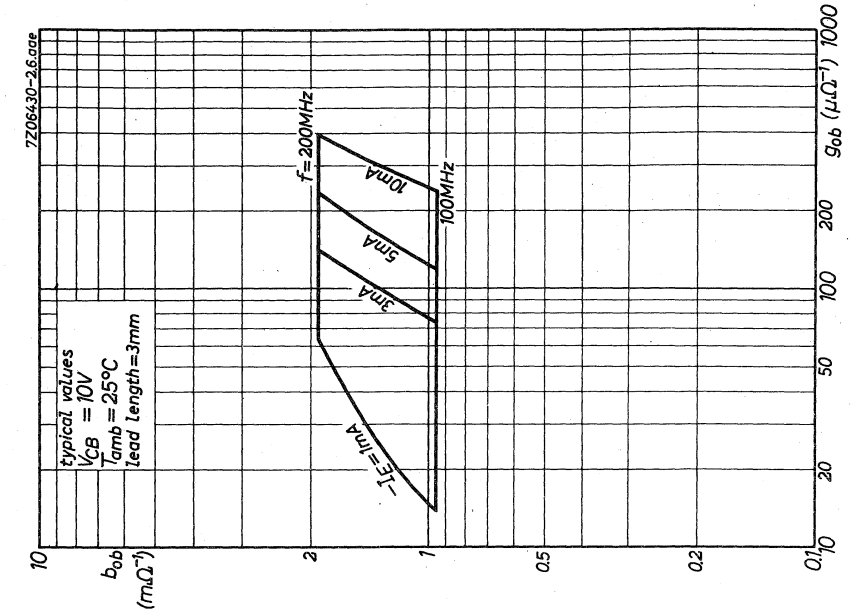

SILICON PLANAR TRANSISTOR

N-P-N transistor in a TO-72 metal envelope intended for use in forward gain control stages in video intermediate frequency amplifiers of television receivers.

| QUICK REFERENCE DATA | | | |
|---|-----------------|------|----------------|
| Collector-base voltage (open emitter) | V_{CBO} | max. | 40 V |
| Collector-emitter voltage (open base) | V_{CEO} | max. | 30 V |
| Collector current (d. c.) | I_C | max. | 25 mA |
| Total power dissipation up to $T_{amb} = 45^\circ C$ | P_{tot} | max. | 130 mW |
| Junction temperature | T_j | max. | 175 $^\circ C$ |
| Transition frequency $I_C = 4 \text{ mA}; V_{CE} = 10 \text{ V}$ | f_T | typ. | 350 MHz |
| Feedback capacitance at $f = 10.7 \text{ MHz}$ $I_C = 1 \text{ mA}; V_{CE} = 10 \text{ V}$ | C_{re} | typ. | 0,15 pF |
| Max. unilateralized power gain $I_C = 4 \text{ mA}; V_{CE} = 10 \text{ V}; f = 35 \text{ MHz}$ | G_{UM} | typ. | 42 dB |
| Gain control range | ΔG_{tr} | typ. | 60 dB |

MECHANICAL DATA

Dimensions in mm

TO-72

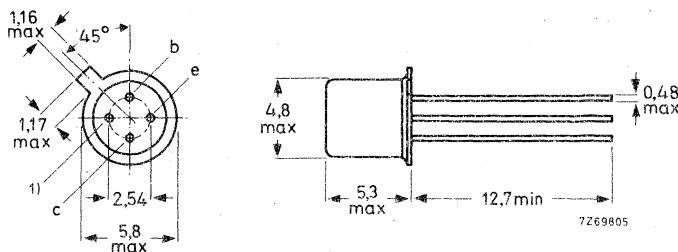

¹⁾ = shield lead (connected to case)

Accessories: 56246 (distance disc), 56263 (cooling fin).

FOR NEW DESIGN THE TYPE BF198 IS RECOMMENDED

RATINGS (Limiting values) ¹⁾Voltages

| | | | |
|--|-----------|------|------|
| Collector-base voltage (open emitter) | V_{CBO} | max. | 40 V |
| Collector-emitter voltage (open base) (See also page 5) | V_{CEO} | max. | 30 V |
| Emitter-base voltage (open collector) | V_{EBO} | max. | 4 V |

Currents

| | | | |
|--------------------------------|----------|------|-------|
| Collector current (d.c.) | I_C | max. | 25 mA |
| Collector current (peak value) | I_{CM} | max. | 25 mA |

Power dissipation

| | | | |
|---|-----------|------|--------|
| Total power dissipation up to $T_{amb} = 45^{\circ}C$ | P_{tot} | max. | 130 mW |
|---|-----------|------|--------|

Temperatures

| | | | |
|----------------------|-----------|-------------|-----------------|
| Storage temperature | T_{stg} | -65 to +175 | $^{\circ}C$ |
| Junction temperature | T_j | max. | 175 $^{\circ}C$ |

THERMAL RESISTANCE

| | | | |
|--------------------------------------|---------------|-----|----------------|
| From junction to ambient in free air | $R_{th\ j-a}$ | 1.0 | $^{\circ}C/mW$ |
|--------------------------------------|---------------|-----|----------------|

¹⁾ Limiting values according to the Absolute Maximum System as defined in IEC publication I34.

CHARACTERISTICS

$T_{amb} = 25\text{ }^{\circ}\text{C}$ unless otherwise specified

Base current

$I_C = 4\text{ mA}; V_{CE} = 10\text{ V}$

I_B typ. 70 μA
 < 150 μA

Base-emitter voltage

$I_C = 4\text{ mA}; V_{CE} = 10\text{ V}$

V_{BE} typ. 700 mV ¹⁾

Feedback capacitance at $f = 10.7\text{ MHz}$

$I_C = 1\text{ mA}; V_{CE} = 10\text{ V}$

C_{re} typ. 150 fF ²⁾

Transition frequency

$I_C = 4\text{ mA}; V_{CE} = 10\text{ V}$

f_T typ. 350 MHz

Noise figure at $f = 35\text{ MHz}$

$I_C = 4\text{ mA}; V_{CE} = 10\text{ V}; G_S = 10\text{ m}\Omega^{-1}; B_S = 0$

F typ. 3 dB

y parameters at $f = 35\text{ MHz}$

$I_C = 4\text{ mA}; V_{CE} = 10\text{ V}$

Input conductance

g_{ie} typ. 4.8 $\text{m}\Omega^{-1}$

Input capacitance

C_{ie} typ. 45 pF

Feedback admittance

$|y_{re}|$ typ. 37 $\mu\Omega^{-1}$

Phase angle of feedback admittance

φ_{re} typ. 268 $^{\circ}$

Transfer admittance

$|y_{fe}|$ typ. 95 $\text{m}\Omega^{-1}$

Phase angle of transfer admittance

φ_{fe} typ. 337 $^{\circ}$

Output conductance

g_{oe} typ. 30 $\mu\Omega^{-1}$

Output capacitance

C_{oe} typ. 1.2 pF

Maximum unilateralised power gain

$$G_{UM} = \frac{|y_{fe}|^2}{4 g_{ie} g_{oe}}$$

$I_C = 4\text{ mA}; V_{CE} = 10\text{ V}; f = 35\text{ MHz}$

G_{UM} typ. 42 dB

¹⁾ V_{BE} decreases with about 1.7 mV/ $^{\circ}\text{C}$ at increasing temperature

²⁾ 1 fF = 1 femtofarad = 10^{-15} F

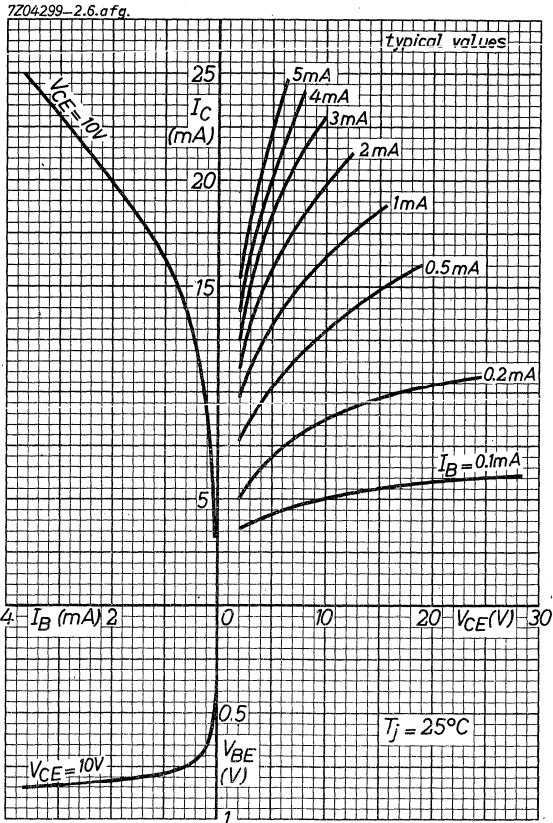

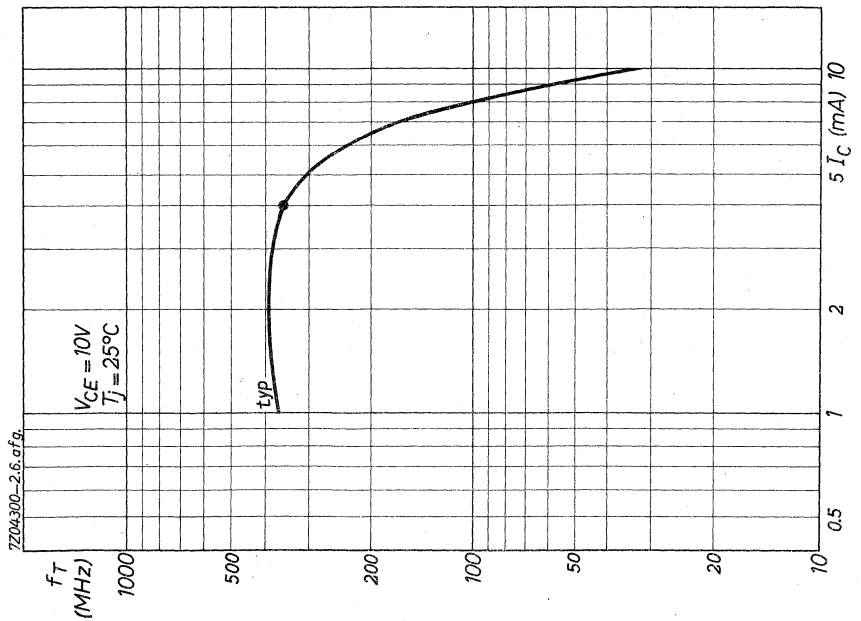
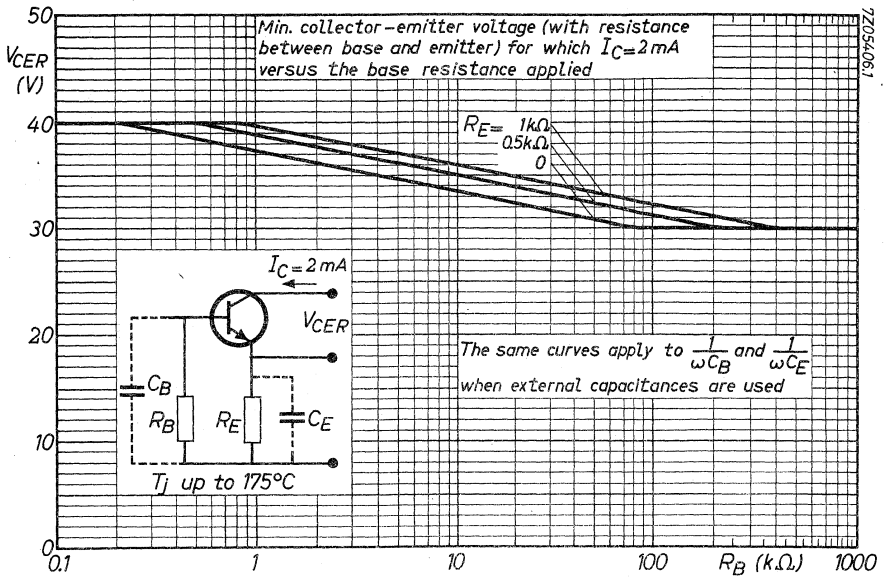

APPLICATION INFORMATION

First stage of an intermediate frequency amplifier with a BF167 transistor.
(Basic circuit with voltage gain control).

Transducer gain

$$G_{tr} = \frac{\text{output power in load } R_L}{\text{available power from source with } R_S}$$

$I_C = 4 \text{ mA}; f = 35 \text{ MHz}$

G_{tr} typ. 26 dB

Gain control range

ΔG_{tr} typ. 60 dB

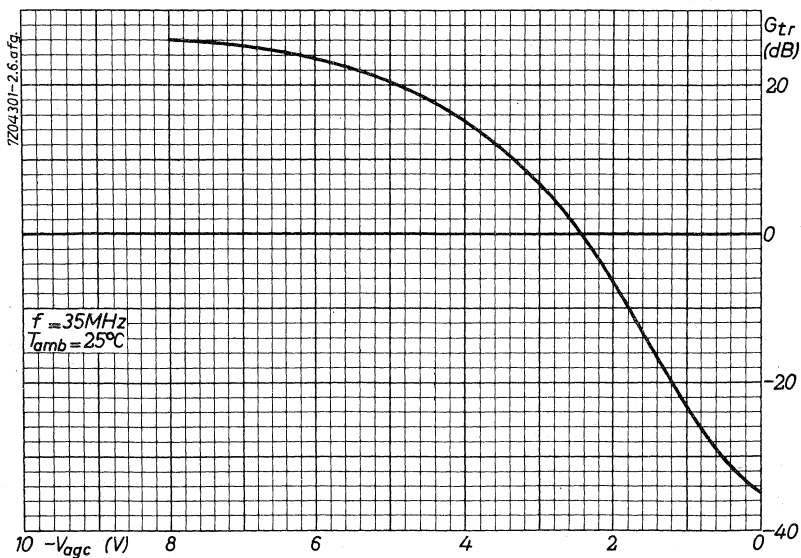
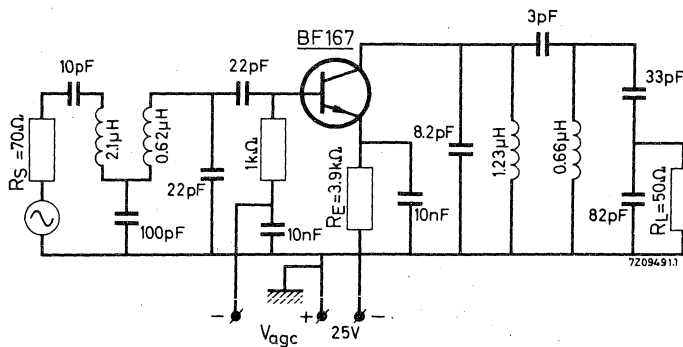

SILICON PLANAR EPITAXIAL TRANSISTOR

N-P-N transistor in a TO-72 metal envelope intended for use in video intermediate frequency amplifiers, in particular for the output stages.

| QUICK REFERENCE DATA | | | |
|--|-----------|------|------------------------|
| Collector-base voltage (open emitter) | V_{CBO} | max. | 40 V |
| Collector-emitter voltage (open base) | V_{CEO} | max. | 25 V |
| Collector current (d. c.) | I_C | max. | 25 mA |
| Total power dissipation up to $T_{amb} = 45\text{ }^{\circ}\text{C}$ | P_{tot} | max. | 260 mW |
| Junction temperature | T_j | max. | 175 $^{\circ}\text{C}$ |
| Transition frequency $I_C = 5\text{ mA}; V_{CE} = 10\text{ V}$ | f_T | typ. | 550 MHz |
| Feedback capacitance at $f = 10,7\text{ MHz}$ $I_C = 1\text{ mA}; V_{CE} = 10\text{ V}$ | C_{re} | typ. | 0,23 pF |
| Max. unilateralized power gain $I_C = 7\text{ mA}; V_{CE} = 10\text{ V}; f = 35\text{ MHz}$ | G_{UM} | typ. | 42,5 dB |
| Output voltage in the circuit of page 4 | V_O | typ. | 7,7 V |

MECHANICAL DATA

Dimensions in mm

TO-72

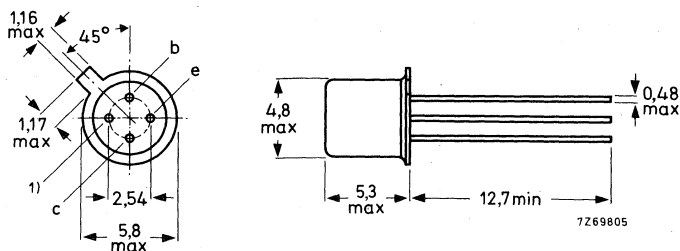

¹⁾ = shield lead (connected to case)

Accessories: 56246 (distance disc), 56263 (cooling fin).

FOR NEW DESIGN THE TYPE BF199 IS RECOMMENDED

RATINGS (Limiting values) ¹⁾

Voltages

| | | | |
|--|------------------|------|------|
| Collector-base voltage (open emitter) | V _{CB0} | max. | 40 V |
| Collector-emitter voltage (open base) (See also page A) | V _{CEO} | max. | 25 V |
| Emitter-base voltage (open collector) | V _{EBO} | max. | 4 V |

Currents

| | | | |
|--------------------------------|-----------------|------|-------|
| Collector current (d.c.) | I _C | max. | 25 mA |
| Collector current (peak value) | I _{CM} | max. | 25 mA |

Power dissipation

| | | | |
|--|------------------|------|--------|
| Total power dissipation up to T _{amb} = 45 °C with cooling fin No. 56263 ²⁾ | P _{tot} | max. | 260 mW |
|--|------------------|------|--------|

Temperatures

| | | |
|----------------------|------------------|----------------|
| Storage temperature | T _{stg} | -65 to +175 °C |
| Junction temperature | T _j | max. 175 °C |

THERMAL RESISTANCE

| | | | |
|--|---------------------|---|------------|
| From junction to ambient in free air | R _{th j-a} | = | 0.65 °C/mW |
| From junction to ambient with cooling fin No. 56263 | R _{th j-a} | = | 0.5 °C/mW |

¹⁾ Limiting values according to the Absolute Maximum System as defined in IEC publication 134.

²⁾ Peak power dissipation see page 5.

CHARACTERISTICS

$T_{amb} = 25\text{ }^{\circ}\text{C}$ unless otherwise specified

Base current

$I_C = 7\text{ mA}; V_{CE} = 10\text{ V}$

I_B typ. 80 μA
< 185 μA

Base-emitter voltage

$I_C = 7\text{ mA}; V_{CE} = 10\text{ V}$

V_{BE} typ. 740 mV ¹⁾
< 900 mV

Feedback capacitance at $f = 10.7\text{ MHz}$

$I_C = 1\text{ mA}; V_{CE} = 10\text{ V}$

C_{re} typ. 230 fF ²⁾

Transition frequency

$I_C = 5\text{ mA}; V_{CE} = 10\text{ V}$

f_T typ. 550 MHz

y parameters at $f = 35\text{ MHz}$

$I_C = 7\text{ mA}; V_{CE} = 10\text{ V}$

Input conductance

g_{ie} typ. 4.5 $\text{m}\Omega^{-1}$

Input capacitance

C_{ie} typ. 45 pF

Feedback admittance

$|y_{re}|$ typ. 55 $\mu\Omega^{-1}$

Phase angle of feedback admittance

φ_{re} typ. 266°

Transfer admittance

$|y_{fe}|$ typ. 145 $\text{m}\Omega^{-1}$

Phase angle of transfer admittance

φ_{fe} typ. 338°

Output conductance

g_{oe} typ. 65 $\mu\Omega^{-1}$

Output capacitance

C_{oe} typ. 2.1 pF

Maximum unilateralised power gain

$$G_{UM} = \frac{|y_{fe}|^2}{4 g_{ie} g_{oe}}$$

$I_C = 7\text{ mA}; V_{CE} = 10\text{ V}; f = 35\text{ MHz}$

G_{UM} typ. 42.5 dB

¹⁾ V_{BE} decreases with about 1.7 mV/ $^{\circ}\text{C}$ at increasing temperature

²⁾ 1 fF = 1 femtofarad = 10^{-15} F

APPLICATION INFORMATION

Output stage of an intermediate frequency amplifier with a BF173 transistor.

Output voltage of the i. f. output stage

Voltage across the detector load $R_L = 2.7 \text{ k}\Omega$
for 30% synchronisation pulse compression

$f = 38.9 \text{ MHz}$; $I_C = 7.2 \text{ mA}$; $V_{CE} = 16.6 \text{ V}$

$V_O > 6 \text{ V}$
typ. 7.7 V

Transducer gain

$$G_{tr} = \frac{\text{output power in load } R_L}{\text{available power from source with } R_S}$$

$f = 36.4 \text{ MHz}$; $I_C = 7.2 \text{ mA}$; $V_{CE} = 16.6 \text{ V}$

G_{tr} typ. 26 dB

Tuning frequency for all tuned circuits is 37 MHz

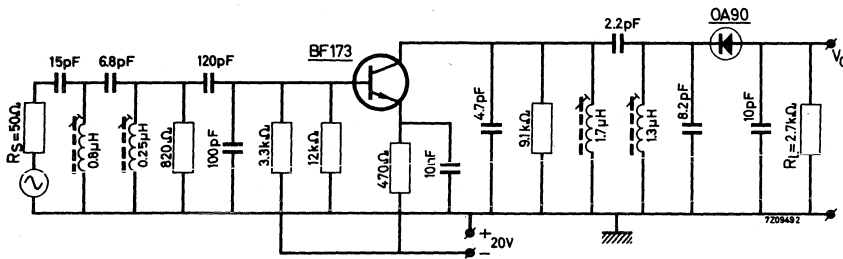

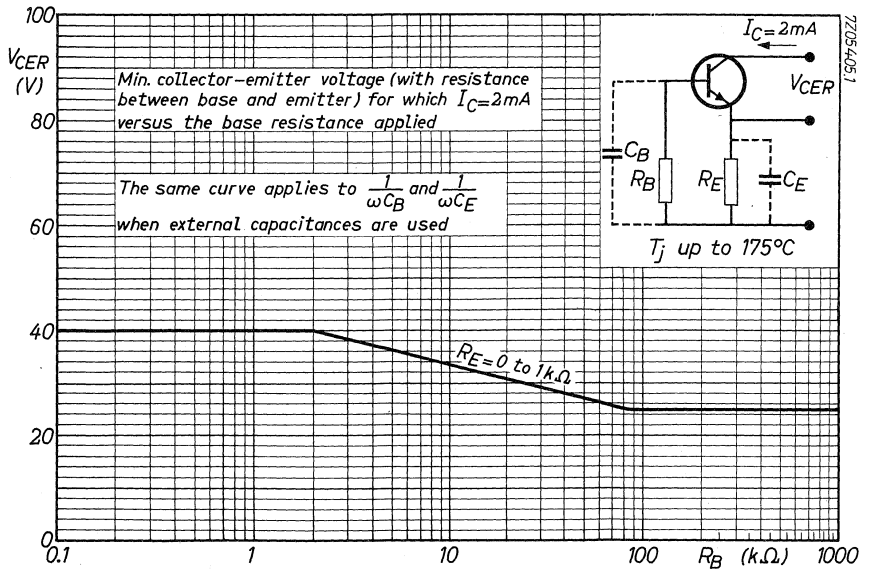
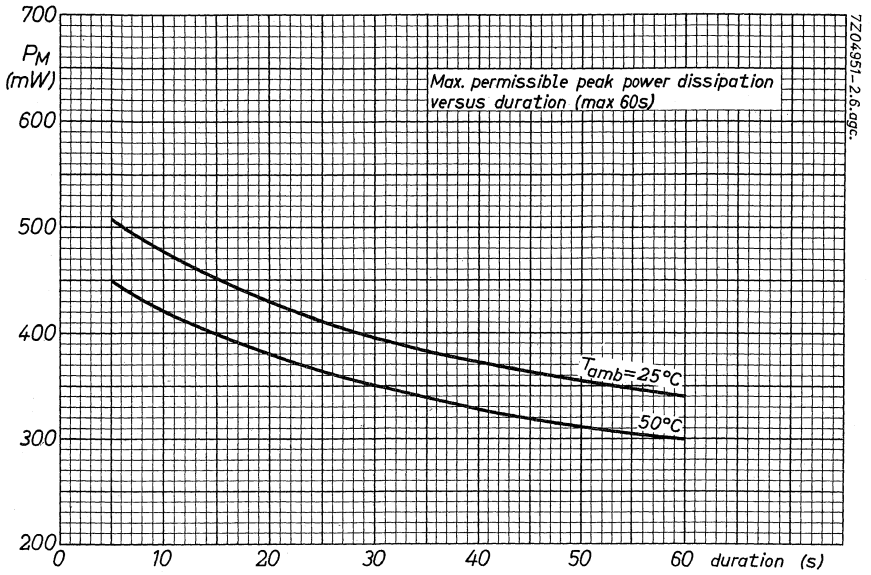

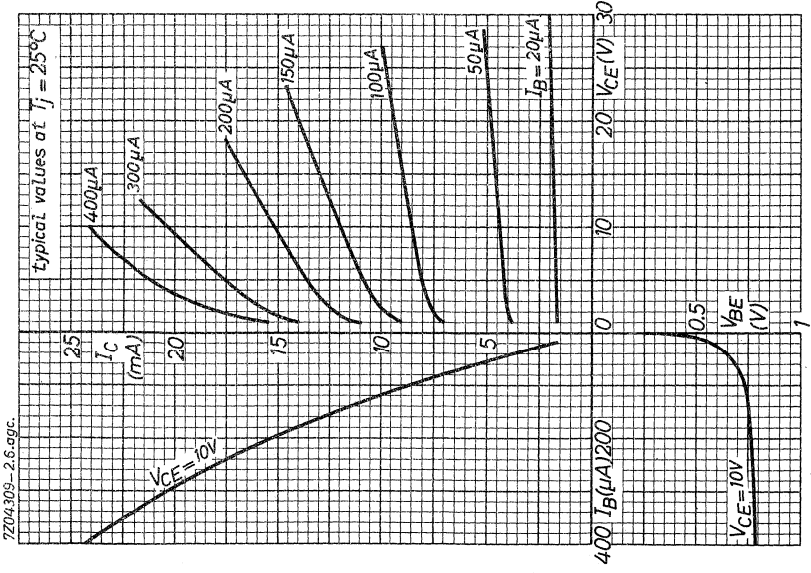
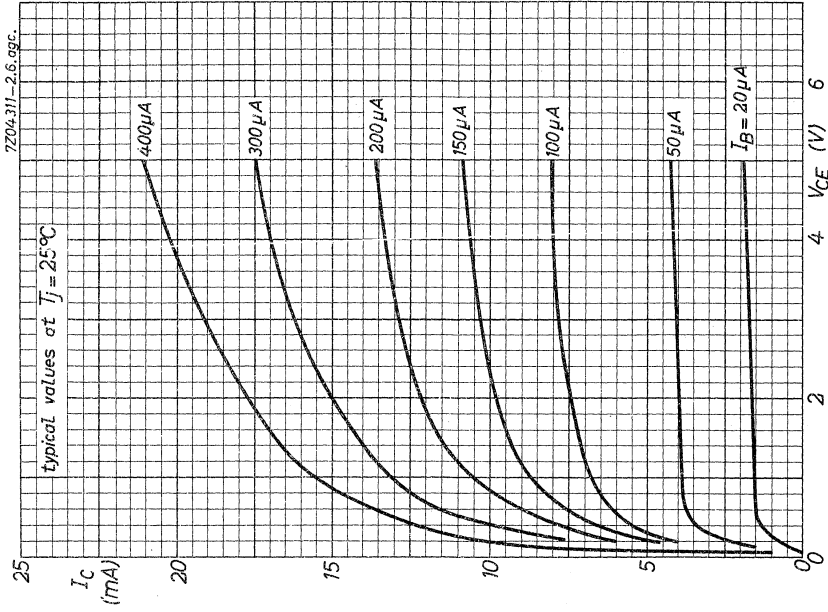

VIDEO OUTPUT TRANSISTORS

N-P-N transistors in a TO-39 metal envelope with the collector connected to the case.

The BF177 is intended for tiny-vision black and white television receivers.

The BF178 and BF179 for application in large screen black and white television receivers.

QUICK REFERENCE DATA

| | | BF177 | BF178 | BF179 |
|--|-------------------------------|----------------|-------|-----------------|
| Collector-base voltage (open emitter) | V_{CBO} max. | 100 | 185 | 250 V |
| Collector-emitter voltage (open base) | V_{CEO} max. | 60 | 115 | 115 V |
| Collector current (peak value) | I_{CM} max. | 50 | 50 | 50 mA |
| Total power dissipation up to $T_{amb} = 65^{\circ}C$ | P_{tot} max. | 0.6 | 0.6 | 0.6 W |
| | up to $T_{mb} = 130^{\circ}C$ | P_{tot} max. | 1.7 | 1.7 W |
| Junction temperature | T_j max. | 200 | 200 | 200 $^{\circ}C$ |
| D.C. current gain at $T_j = 25^{\circ}C$ | | | | |
| $I_C = 15$ mA; $V_{CE} = 10$ V | h_{FE} | > 20 | | |
| $I_C = 20$ mA; $V_{CE} = 15$ V | h_{FE} | > | | 20 |
| $I_C = 30$ mA; $V_{CE} = 20$ V | h_{FE} | > | 20 | |
| Transition frequency | | | | |
| $I_C = 10$ mA; $V_{CE} = 10$ V | f_T typ. | 120 | 120 | 120 MHz |
| Feedback capacitance | | | | |
| $I_C = 10$ mA; $V_{CE} = 20$ V | C_{re} typ. | 1.8 | 1.8 | 1.8 pF |

MECHANICAL DATA

TO-39

Collector connected to case

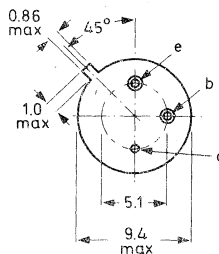

Dimensions in mm

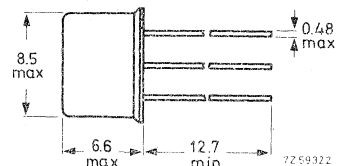

Accessories available: 56218; 56245

FOR NEW DESIGN THE SUCCESSOR TYPES BF336 to 338
ARE RECOMMENDED

RATINGS Limiting values in accordance with the Absolute Maximum System (IEC134)

Voltages

| | | BF177 | BF178 | BF179 | |
|---|-----------|----------|-------|-------|-----------------|
| Collector-base voltage (open emitter) | V_{CBO} | max. 100 | 185 | 250 | V ¹⁾ |
| Collector-emitter voltage ($R_B \leq 1\text{ k}\Omega$) | V_{CER} | max. 100 | 185 | 250 | V ¹⁾ |
| Collector-emitter voltage (open base) | | | | | |
| $I_C = 4\text{ mA}$ | V_{CEO} | max. 60 | 115 | 115 | V |
| Emitter-base voltage (open collector) | V_{EBO} | max. 5 | 5 | 5 | V |

Currents

| | | | | | |
|--------------------------------|----------|---------|----|----|----|
| Collector current (d. c.) | I_C | max. 50 | 50 | 50 | mA |
| Collector current (peak value) | I_{CM} | max. 50 | 50 | 50 | mA |

Power dissipation

| | | | | | |
|--|-----------|----------|-----|-----|---|
| Total power dissipation | | | | | |
| up to $T_{amb} = 65\text{ }^\circ\text{C}$ in free air | P_{tot} | max. 0.6 | 0.6 | 0.6 | W |
| up to $T_{mb} = 130\text{ }^\circ\text{C}$ | P_{tot} | max. | 1.7 | 1.7 | W |

Temperatures

| | | | | |
|----------------------|-----------|------------------------------|--|--|
| Storage temperature | T_{stg} | -55 to +175 $^\circ\text{C}$ | | |
| Junction temperature | T_j | max. 200 $^\circ\text{C}$ | | |

THERMAL RESISTANCE

| | | BF177 | BF178 | BF179 | |
|--------------------------------------|----------------|-------|-------|-------|--------------------|
| From junction to ambient in free air | $R_{th\ j-a}$ | = 220 | 220 | 220 | $^\circ\text{C/W}$ |
| From junction to mounting base | $R_{th\ j-mb}$ | = | 40 | 40 | $^\circ\text{C/W}$ |

CHARACTERISTICS

| | | | | | |
|--|-----------|-----------|------|------|----|
| Collector cut-off current at $T_j = 200\text{ }^\circ\text{C}$ | I_{CER} | typ. 0.03 | 0.05 | 0.10 | mA |
| | | < 4 | 4 | 4 | mA |

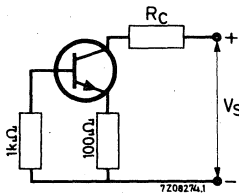

at V_{CERmax} ; $T_j = 25\text{ }^\circ\text{C}$ $I_{CER} < 1\text{ mA}$

| | V_S | R_C |
|-------|-------|----------------------|
| BF177 | 100 V | 3.9 $\text{k}\Omega$ |
| BF178 | 165 V | 3.9 $\text{k}\Omega$ |
| BF179 | 260 V | 10 $\text{k}\Omega$ |

1) During switching on, a supply voltage of 1.2 times the rated V_{CER} value is permitted.

The current must be limited so that maximum dissipation and maximum junction temperature are not exceeded (see page 6).

CHARACTERISTICS (continued)

$T_j = 25\text{ }^\circ\text{C}$ unless otherwise specified

Base current

| | | | |
|--|--------------|-------|---------------------------|
| $I_C = 15\text{ mA}; V_{CE} = 10\text{ V}$ | <u>BF177</u> | I_B | typ. 0.36 mA < 0.75 mA |
| $I_C = 20\text{ mA}; V_{CE} = 15\text{ V}$ | <u>BF179</u> | I_B | typ. 0.45 mA < 1.0 mA |
| $I_C = 30\text{ mA}; V_{CE} = 20\text{ V}$ | <u>BF178</u> | I_B | typ. 0.72 mA < 1.5 mA |

Base-emitter voltage ¹⁾

| | | |
|---|------------|-------------|
| $I_C = 15\text{ mA}; V_{CE} = 10\text{ V}$ for <u>BF177</u> | } V_{BE} | typ. 0.75 V |
| $I_C = 20\text{ mA}; V_{CE} = 15\text{ V}$ for <u>BF179</u> | | < 1.2 V |
| $I_C = 30\text{ mA}; V_{CE} = 20\text{ V}$ for <u>BF178</u> | | |

High frequency knee voltage at $T_j = 150\text{ }^\circ\text{C}$

| | | |
|-------------------------------------|-----------|-----------|
| <u>BF177</u> : $I_C = 15\text{ mA}$ | V_{CEK} | typ. 10 V |
| <u>BF179</u> : $I_C = 20\text{ mA}$ | V_{CEK} | typ. 15 V |
| <u>BF178</u> : $I_C = 30\text{ mA}$ | V_{CEK} | typ. 20 V |

The high frequency knee voltage of a transistor is that value of the collector-emitter voltage at which the small signal gain, measured in a practical circuit, has dropped to 80% of the gain at $V_{CE} = 50\text{ V}$. A further decrease of the collector-emitter voltage results in a rapid increase of the distortion of the signal.

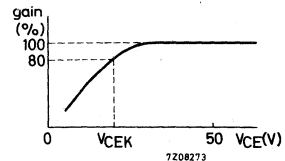
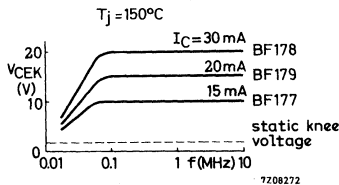

Feedback capacitance at $f = 0.5\text{ MHz}$

| | | |
|--|----------|-------------------------|
| $I_C = 10\text{ mA}; V_{CE} = 20\text{ V}$ | C_{re} | typ. 1.8 pF < 3.5 pF |
|--|----------|-------------------------|

Feedback time constant at $f = 10\text{ MHz}$

| | | |
|---|-------------------------|------------------------|
| $-I_E = 10\text{ mA}; V_{CB} = 10\text{ V}$ | $r_{bb}' \cdot C_{b'c}$ | typ. 25 ps < 100 ps |
|---|-------------------------|------------------------|

Transition frequency

| | | |
|--|-------|--------------|
| $I_C = 10\text{ mA}; V_{CE} = 10\text{ V}$ | f_T | typ. 120 MHz |
|--|-------|--------------|

¹⁾ V_{BE} decreases by about $1.6\text{ mV}/^\circ\text{C}$ with increasing temperature.

SILICON PLANAR TRANSISTOR

N-P-N transistor in a TO-72 metal envelope with insulated electrodes and a shield lead connected to the case. The BF180 is primarily intended for application in a forward gain controlled pre-amplifier in u.h.f. and integrated television tuners.

| QUICK REFERENCE DATA | | | |
|--|-----------|------|----------------------|
| Collector-base voltage (open emitter) | V_{CBO} | max. | 30 V |
| Collector-emitter voltage (open base) | V_{CEO} | max. | 20 V |
| Collector current (d.c.) | I_C | max. | 20 mA |
| Total power dissipation up to $T_{amb} = 25\text{ }^\circ\text{C}$ | P_{tot} | max. | 150 mW |
| Junction temperature | T_j | max. | 175 $^\circ\text{C}$ |
| Transition frequency | | | |
| $I_C = 2\text{ mA}; V_{CE} = 10\text{ V}$ | f_T | typ. | 675 MHz |
| Feedback capacitance at $f = 10.7\text{ MHz}$ | | | |
| $I_C = 1\text{ mA}; V_{CE} = 10\text{ V}$ | C_{re} | typ. | 280 fF |
| Max. unilateralised power gain | | | |
| $-I_E = 2\text{ mA}; V_{CB} = 10\text{ V}; f = 200\text{ MHz}$ | GUM | typ. | 24 dB |
| $-I_E = 2\text{ mA}; V_{CB} = 10\text{ V}; f = 900\text{ MHz}$ | GUM | typ. | 12 dB |
| Noise figure at optimum source admittance | | | |
| $-I_E = 2\text{ mA}; V_{CB} = 10\text{ V}; f = 200\text{ MHz}$ | F | typ. | 2.5 dB |
| $-I_E = 2\text{ mA}; V_{CB} = 10\text{ V}; f = 800\text{ MHz}$ | F | typ. | 5.7 dB |

MECHANICAL DATA

Dimensions in mm

TO-72

Accessories supplied on request: 56246, 56263.

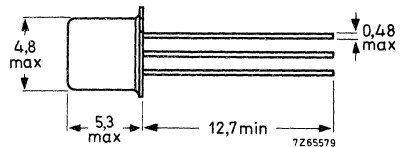
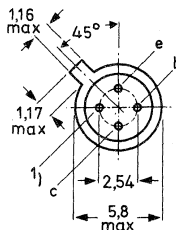

1) Shield lead connected to case.

RATINGS (Limiting values) ¹⁾

Voltages

| | | | |
|---------------------------------------|-----------|------|------|
| Collector-base voltage (open emitter) | V_{CBO} | max. | 30 V |
| Collector-emitter voltage (open base) | V_{CEO} | max. | 20 V |
| Emitter-base voltage (open collector) | V_{EBO} | max. | 3 V |

Currents

| | | | |
|--------------------------------|----------|------|-------|
| Collector current (d.c.) | I_C | max. | 20 mA |
| Collector current (peak value) | I_{CM} | max. | 20 mA |

Power dissipation

| | | | |
|--|-----------|------|--------|
| Total power dissipation up to $T_{amb} = 25\text{ }^\circ\text{C}$ | P_{tot} | max. | 150 mW |
|--|-----------|------|--------|

Temperatures

| | | | |
|----------------------|-----------|-------------|----------------------|
| Storage temperature | T_{stg} | -65 to +175 | $^\circ\text{C}$ |
| Junction temperature | T_j | max. | 175 $^\circ\text{C}$ |

THERMAL RESISTANCE

| | | | |
|--------------------------------------|---------------|---|------------------------------|
| From junction to ambient in free air | $R_{th\ j-a}$ | = | 1 $^\circ\text{C}/\text{mW}$ |
|--------------------------------------|---------------|---|------------------------------|

¹⁾ Limiting values according to the Absolute Maximum System as defined in IEC publication 134.

CHARACTERISTICS

$T_{amb} = 25\text{ }^{\circ}\text{C}$ unless otherwise specified

Base current

$-I_E = 2\text{ mA}; V_{CB} = 10\text{ V}$

I_B typ. 45 μA
< 150 μA

$-I_E = 12\text{ mA}; V_{CB} = 7\text{ V}$

I_B < 2.2 mA

Emitter-base voltage

$-I_E = 2\text{ mA}; V_{CB} = 10\text{ V}$

$-V_{EB}$ typ. 0.75 V

Feedback capacitance at $f = 10.7\text{ MHz}$

$I_C = 1\text{ mA}; V_{CE} = 10\text{ V}$

C_{re} typ. 280 fF¹⁾

Transition frequency

$I_C = 2\text{ mA}; V_{CE} = 10\text{ V}$

f_T typ. 675 MHz

Noise figure²⁾

$-I_E = 2\text{ mA}; V_{CB} = 10\text{ V};$

$G_S = 40\text{ m}\Omega^{-1}; B_S = 0; f = 200\text{ MHz}$

F typ. 4.5 dB

$-I_E = 2\text{ mA}; V_{CB} = 10\text{ V};$

$G_S = 10\text{ m}\Omega^{-1}; B_S = 0; f = 800\text{ MHz}$

F typ. 7.0 dB
< 9.5 dB

Maximum unilateralised power gain²⁾

$$G_{UM} = \frac{|y_{fb}|^2}{4 g_{ib} g_{ob}}$$

$-I_E = 2\text{ mA}; V_{CB} = 10\text{ V}; f = 50\text{ MHz}$

G_{UM} > 32 dB

$-I_E = 2\text{ mA}; V_{CB} = 10\text{ V}; f = 200\text{ MHz}$

G_{UM} typ. 24 dB

$-I_E = 2\text{ mA}; V_{CB} = 10\text{ V}; f = 500\text{ MHz}$

G_{UM} typ. 14 dB

$-I_E = 2\text{ mA}; V_{CB} = 10\text{ V}; f = 900\text{ MHz}$

G_{UM} typ. 12 dB

Transducer gain²⁾

$-I_E = 2\text{ mA}; V_{CB} = 10\text{ V}; f = 200\text{ MHz};$

$G_S = 40\text{ m}\Omega^{-1}; B_S = 0$

$G_L = 1\text{ m}\Omega^{-1}; B_L : \text{tuned}$

G_{tr} typ. 16.5 dB

$-I_E = 2\text{ mA}; V_{CB} = 10\text{ V}; f = 900\text{ MHz};$

$G_S = 20\text{ m}\Omega^{-1}; B_S = 0$

$G_L = 2\text{ m}\Omega^{-1}; B_L : \text{tuned}$

G_{tr} > 7.5 dB
typ. 9 dB

1) 1 fF = 1 femtofarad = 10^{-15} F

2) Common base configuration, metal envelope contacted to earth directly, external lead length: 1 mm.

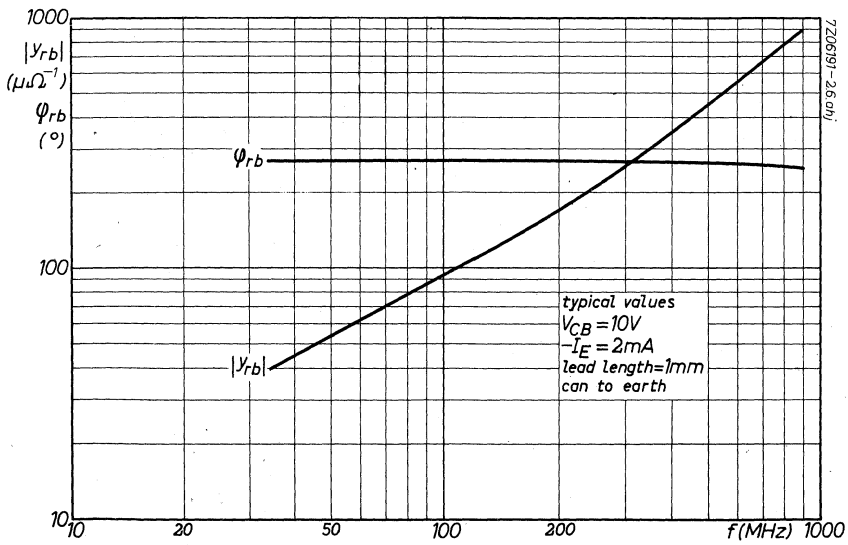
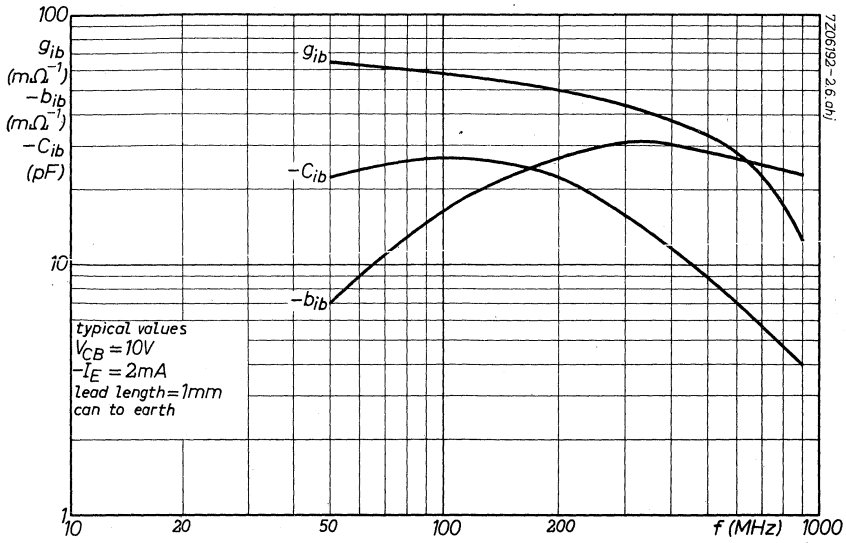

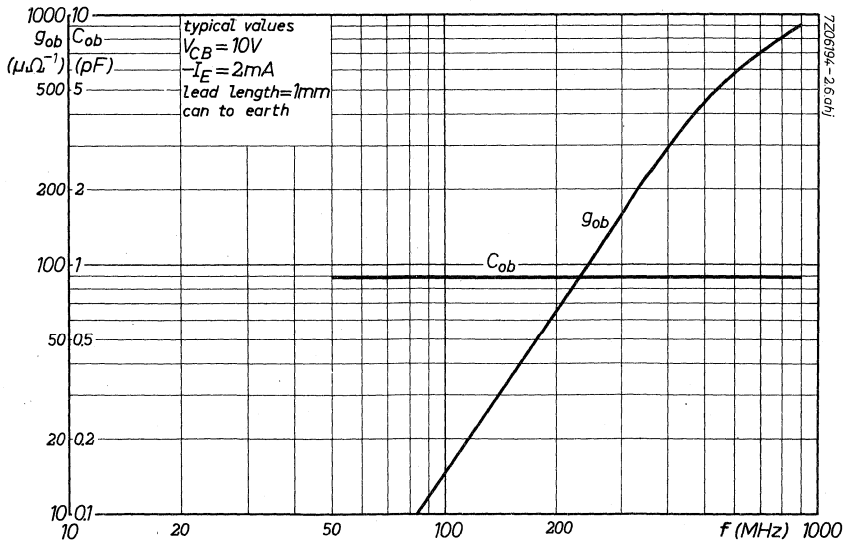
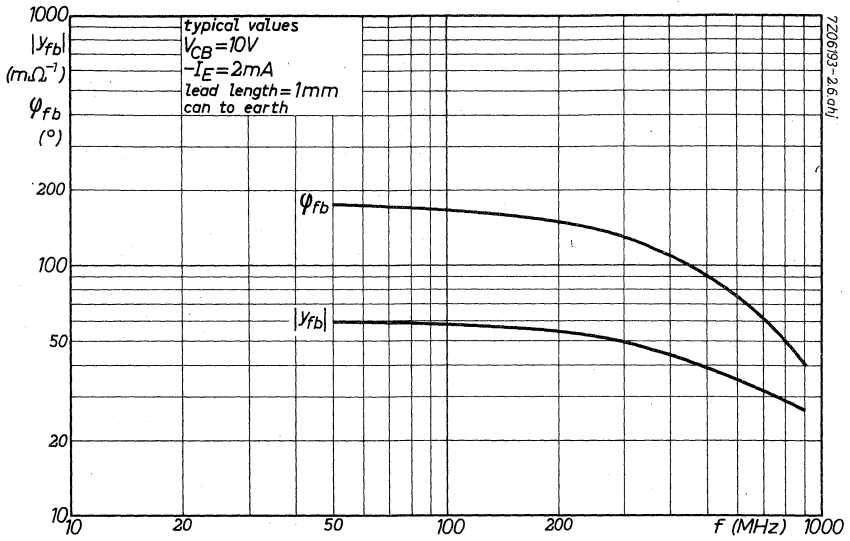

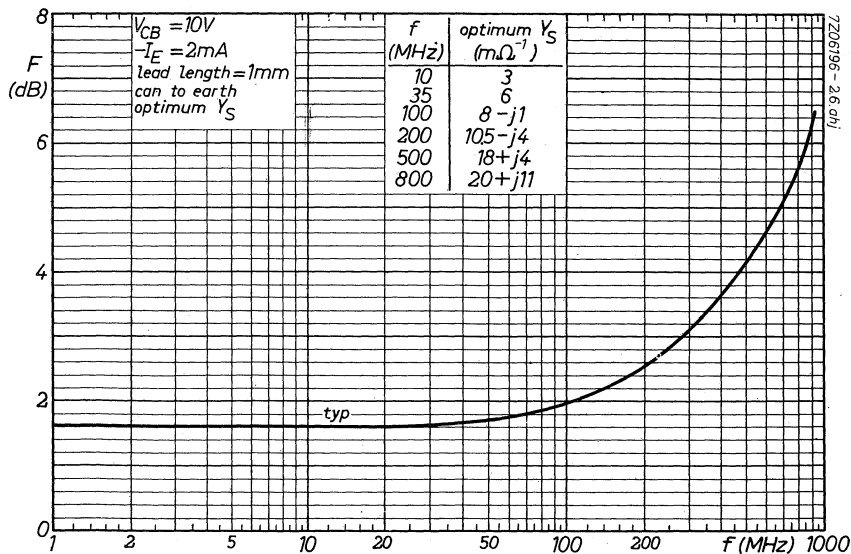
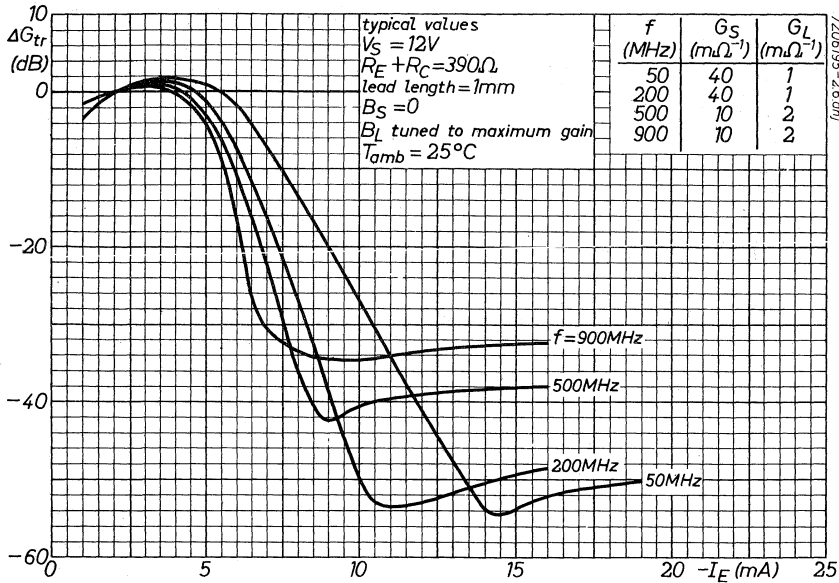

SILICON PLANAR TRANSISTOR

N-P-N transistor in a TO-72 metal envelope with insulated electrodes and a shield lead connected to the case. The BF181 is primarily intended for application as mixer-oscillator in the u. h. f. band.

QUICK REFERENCE DATA

| | | |
|--|-----------|---------------------------|
| Collector-base voltage (open emitter) | V_{CBO} | max. 30 V |
| Collector-emitter voltage (open base) | V_{CEO} | max. 20 V |
| Collector current (d.c.) | I_C | max. 20 mA |
| Total power dissipation up to $T_{amb} = 25\text{ }^\circ\text{C}$ | P_{tot} | max. 150 mW |
| Junction temperature | T_j | max. 175 $^\circ\text{C}$ |
| Transition frequency | | |
| $I_C = 2\text{ mA}; V_{CE} = 10\text{ V}$ | f_T | typ. 600 MHz |
| Feedback capacitance at $f = 10.7\text{ MHz}$ | | |
| $I_C = 1\text{ mA}; V_{CE} = 10\text{ V}$ | C_{re} | typ. 280 fF |
| Max. unilateralised power gain | | |
| $-I_E = 2\text{ mA}; V_{CB} = 10\text{ V}; f = 900\text{ MHz}$ | G_{UM} | typ. 11 dB |
| Noise figure at optimum source admittance | | |
| $-I_E = 2\text{ mA}; V_{CB} = 10\text{ V}; f = 900\text{ MHz}$ | F | typ. 6,8 dB |

MECHANICAL DATA

Dimensions in mm

TO-72

Accessories supplied on request: 56246, 56263.

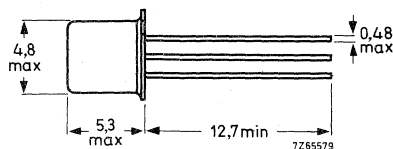
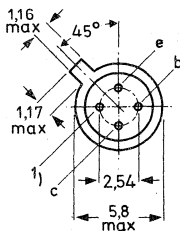

1) Shield lead connected to case.

RATINGS (Limiting values) ¹⁾

Voltages

| | | | |
|---------------------------------------|-----------|------|------|
| Collector-base voltage (open emitter) | V_{CBO} | max. | 30 V |
| Collector-emitter voltage (open base) | V_{CEO} | max. | 20 V |
| Emitter-base voltage (open collector) | V_{EBO} | max. | 3 V |

Currents

| | | | |
|--------------------------------|----------|------|-------|
| Collector current (d.c.) | I_C | max. | 20 mA |
| Collector current (peak value) | I_{CM} | max. | 20 mA |

Power dissipation

| | | | |
|--|-----------|------|--------|
| Total power dissipation up to $T_{amb} = 25\text{ }^\circ\text{C}$ | P_{tot} | max. | 150 mW |
|--|-----------|------|--------|

Temperatures

| | | | |
|----------------------|-----------|-------------|----------------------|
| Storage temperature | T_{stg} | -65 to +175 | $^\circ\text{C}$ |
| Junction temperature | T_j | max. | 175 $^\circ\text{C}$ |

THERMAL RESISTANCE

| | | | |
|--------------------------------------|---------------|---|------------------------------|
| From junction to ambient in free air | $R_{th\ j-a}$ | = | 1 $^\circ\text{C}/\text{mW}$ |
|--------------------------------------|---------------|---|------------------------------|

¹⁾ Limiting values according to the Absolute Maximum System as defined in IEC publication 134.

CHARACTERISTICS

$T_{amb} = 25\text{ }^{\circ}\text{C}$ unless otherwise specified

Base current

$-I_E = 2\text{ mA}; V_{CB} = 10\text{ V}$ I_B typ. 70 μA
 $<$ 150 μA

Emitter-base voltage

$-I_E = 2\text{ mA}; V_{CB} = 10\text{ V}$ $-V_{EB}$ typ. 0.75 V

Feedback capacitance at $f = 10.7\text{ MHz}$

$I_C = 1\text{ mA}; V_{CE} = 10\text{ V}$ C_{re} typ. 280 fF¹⁾

Transition frequency

$I_C = 2\text{ mA}; V_{CE} = 10\text{ V}$ f_T typ. 600 MHz

y parameters at $f = 35\text{ MHz}$ ²⁾

$-I_E = 2\text{ mA}; V_{CB} = 10\text{ V}$

Output conductance g_{ob} typ. 10 $\mu\Omega^{-1}$

Output capacitance C_{ob} typ. 0.9 pF

Maximum unilateralised power gain ²⁾

$$G_{UM} = \frac{|\dot{y}_{fb}|^2}{4 g_{ib} g_{ob}}$$

$-I_E = 2\text{ mA}; V_{CB} = 10\text{ V}; f = 500\text{ MHz}$ G_{UM} typ. 13.5 dB

$-I_E = 2\text{ mA}; V_{CB} = 10\text{ V}; f = 900\text{ MHz}$ G_{UM} typ. 11 dB

Transducer gain ²⁾

$-I_E = 2\text{ mA}; V_{CB} = 10\text{ V}; f = 900\text{ MHz};$

$G_S = 20\text{ m}\Omega^{-1}; B_S = 0$

$G_L = 2\text{ m}\Omega^{-1}; B_L : \text{tuned}$ G_{tr} typ. 8 dB

1) 1 fF = 1 femtofarad = 10^{-15} F .

2) Common base configuration, metal envelope contacted to earth directly, external lead length: 1 mm.

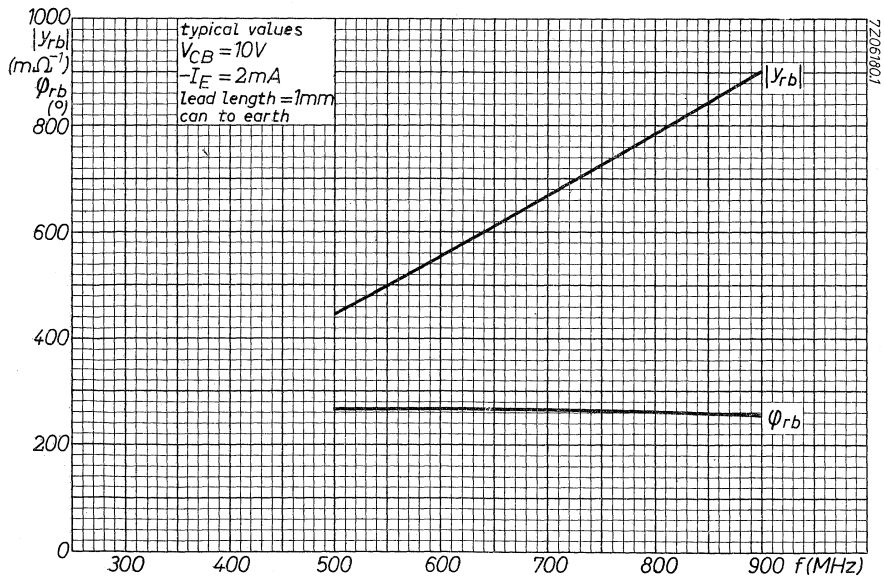
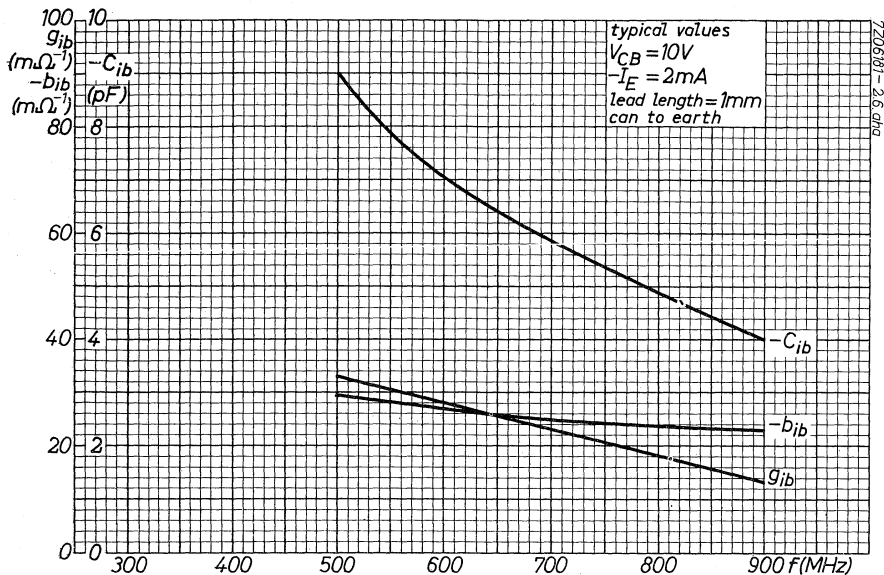

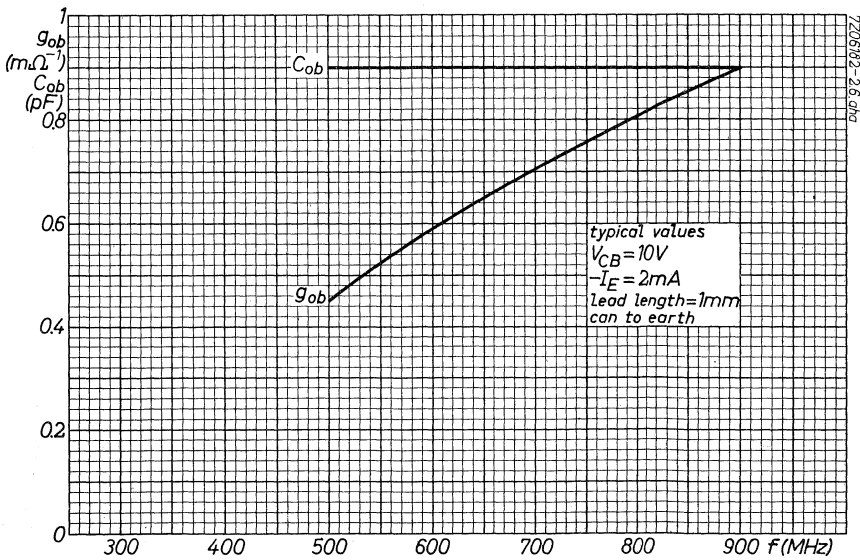
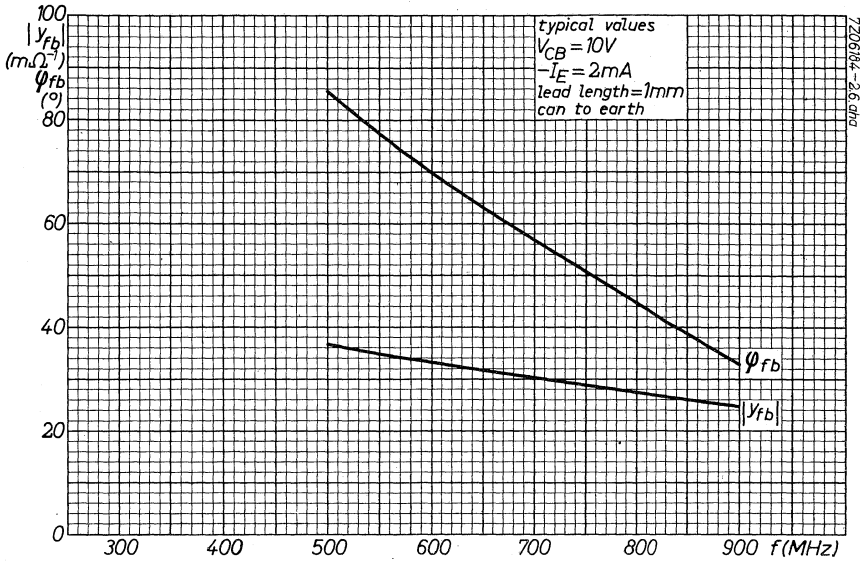

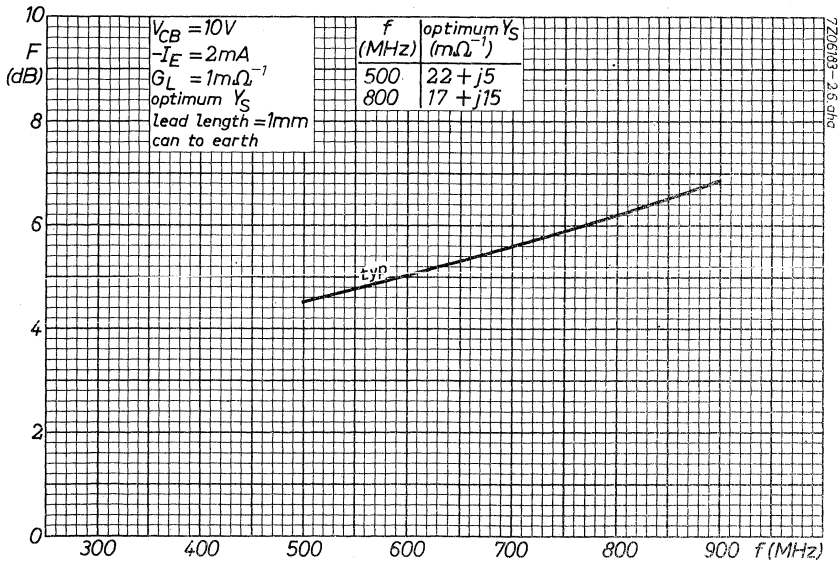

U.H.F. SILICON PLANAR TRANSISTOR

N-P-N transistor in a TO-72 metal envelope with insulated electrodes and a shield lead connected to the case. The BF182 is primarily intended for application as mixer in integrated television tuners.

| QUICK REFERENCE DATA | | | |
|--|-----------|------|----------------------|
| Collector-base voltage (open emitter) | V_{CBO} | max. | 25 V |
| Collector-emitter voltage (open base) | V_{CEO} | max. | 20 V |
| Collector current (d.c.) | I_C | max. | 15 mA |
| Total power dissipation up to $T_{amb} = 25\text{ }^\circ\text{C}$ | P_{tot} | max. | 150 mW |
| Junction temperature | T_j | max. | 175 $^\circ\text{C}$ |
| Transition frequency | | | |
| $I_C = 2\text{ mA}; V_{CE} = 10\text{ V}$ | f_T | typ. | 650 MHz |
| Max. unilateralised power gain | | | |
| $-I_E = 2\text{ mA}; V_{CB} = 10\text{ V}; f = 900\text{ MHz}$ | G_{UM} | typ. | 11 dB |
| Noise figure at optimum source admittance | | | |
| $-I_E = 2\text{ mA}; V_{CB} = 10\text{ V}; f = 800\text{ MHz}$ | F | typ. | 7.4 dB |

MECHANICAL DATA

Dimensions in mm

TO-72

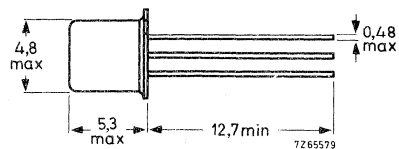
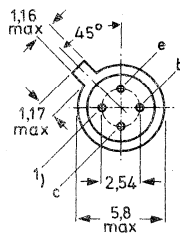

Accessories supplied on request: 56246, 56263.

1) Shield lead connected to case.

RATINGS (Limiting values) ¹⁾

Voltages

| | | | |
|---------------------------------------|-----------|------|------|
| Collector-base voltage (open emitter) | V_{CBO} | max. | 25 V |
| Collector-emitter voltage (open base) | V_{CEO} | max. | 20 V |
| Emitter-base voltage (open collector) | V_{EBO} | max. | 3 V |

Currents

| | | | |
|--------------------------------|----------|------|-------|
| Collector current (d.c.) | I_C | max. | 15 mA |
| Collector current (peak value) | I_{CM} | max. | 15 mA |

Power dissipation

| | | | |
|--|-----------|------|--------|
| Total power dissipation up to $T_{amb} = 25\text{ }^\circ\text{C}$ | P_{tot} | max. | 150 mW |
|--|-----------|------|--------|

Temperatures

| | | | |
|----------------------|-----------|-------------|----------------------|
| Storage temperature | T_{stg} | -65 to +175 | $^\circ\text{C}$ |
| Junction temperature | T_j | max. | 175 $^\circ\text{C}$ |

THERMAL RESISTANCE

| | | | |
|--------------------------------------|---------------|---|------------------------------|
| From junction to ambient in free air | $R_{th\ j-a}$ | = | 1 $^\circ\text{C}/\text{mW}$ |
|--------------------------------------|---------------|---|------------------------------|

CHARACTERISTICS

$T_{amb} = 25\text{ }^\circ\text{C}$ unless otherwise specified

Base current

| | | | |
|--|-------|------|-------------------|
| $-I_E = 2\text{ mA}; V_{CB} = 10\text{ V}$ | I_B | typ. | 100 μA |
| | | < | 200 μA |

Emitter-base voltage ²⁾

| | | | |
|--|-----------|------|--------|
| $-I_E = 2\text{ mA}; V_{CB} = 10\text{ V}$ | $-V_{EB}$ | typ. | 770 mV |
|--|-----------|------|--------|

Transition frequency

| | | | |
|---|-------|------|---------|
| $I_C = 2\text{ mA}; V_{CE} = 10\text{ V}$ | f_T | typ. | 650 MHz |
|---|-------|------|---------|

Feedback capacitance at $f = 10.7\text{ MHz}$

| | | | |
|---|----------|------|--------|
| $I_C = 1\text{ mA}; V_{CE} = 10\text{ V}$ | C_{re} | typ. | 330 fF |
|---|----------|------|--------|

1) Limiting values according to the Absolute Maximum System as defined in IEC publication 134.

2) $-V_{EB}$ decreases by about 1.6 mV/ $^\circ\text{C}$ with increasing temperature.

CHARACTERISTICS (continued)

$T_{amb} = 25\text{ }^{\circ}\text{C}$ unless otherwise specified

Output conductance at $f = 35\text{ MHz}$

$-I_E = 2\text{ mA}; V_{CB} = 10\text{ V}$ g_{ob} typ. $8\text{ }\mu\Omega^{-1}$

Transducer gain at $f = 900\text{ MHz}$ (common base) ¹⁾

$-I_E = 2\text{ mA}; V_{CB} = 10\text{ V}$
 $G_S = 20\text{ m}\Omega^{-1}; G_L = 2\text{ m}\Omega^{-1}$ G_{tr} $>$ 8 dB
typ. 10 dB

Max. unilateralised power gain

$$G_{UM} = \frac{|y_{fb}|^2}{4 g_{ib} g_{ob}}$$

$-I_E = 2\text{ mA}; V_{CB} = 10\text{ V}; f = 500\text{ MHz}$ G_{UM} typ. 15 dB

$-I_E = 2\text{ mA}; V_{CB} = 10\text{ V}; f = 900\text{ MHz}$ G_{UM} typ. 11 dB

Noise figure at optimum source admittance

$-I_E = 2\text{ mA}; V_{CB} = 10\text{ V}; f = 200\text{ MHz}$ F typ. 3.3 dB

$-I_E = 2\text{ mA}; V_{CB} = 10\text{ V}; f = 800\text{ MHz}$ F typ. 7.4 dB

¹⁾ Envelope connected to earth directly, lead length = 3 mm.

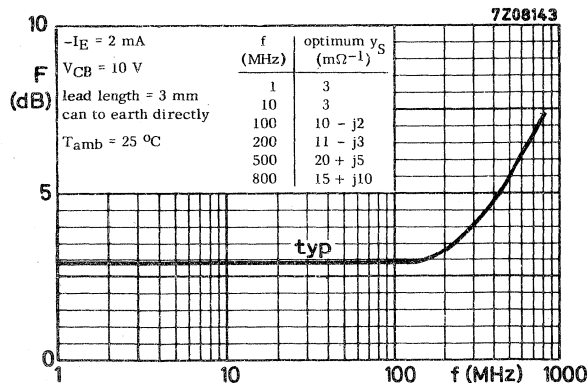

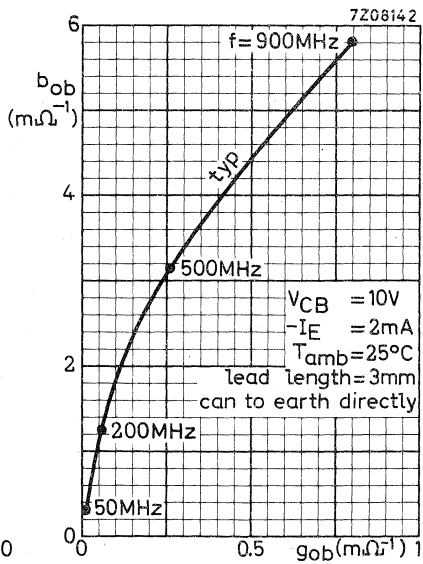
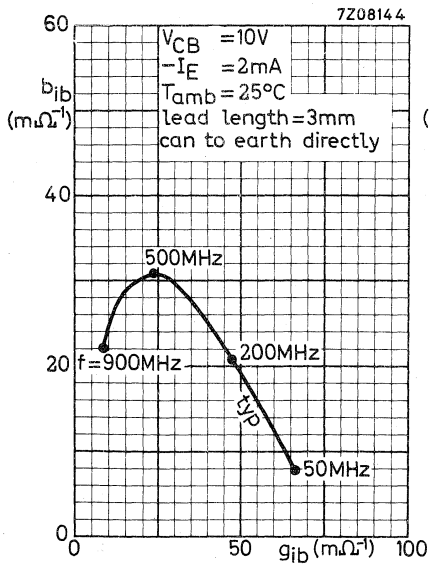
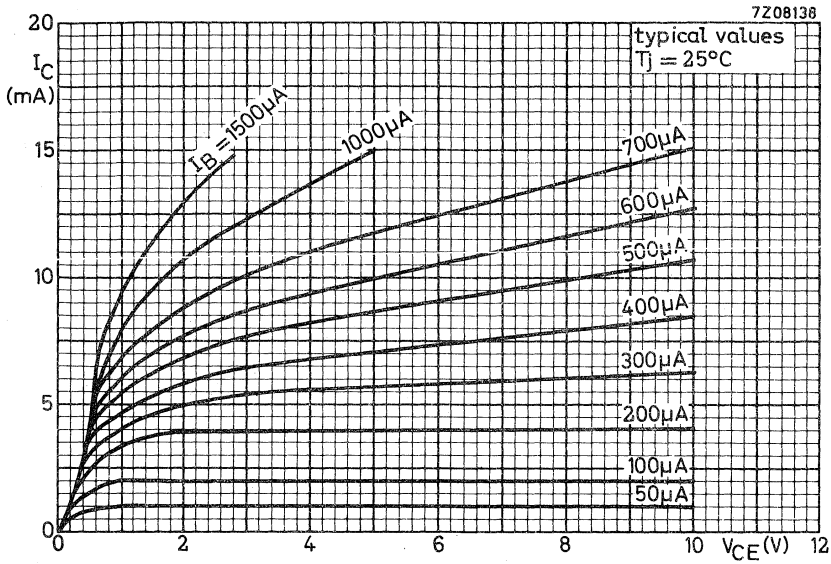

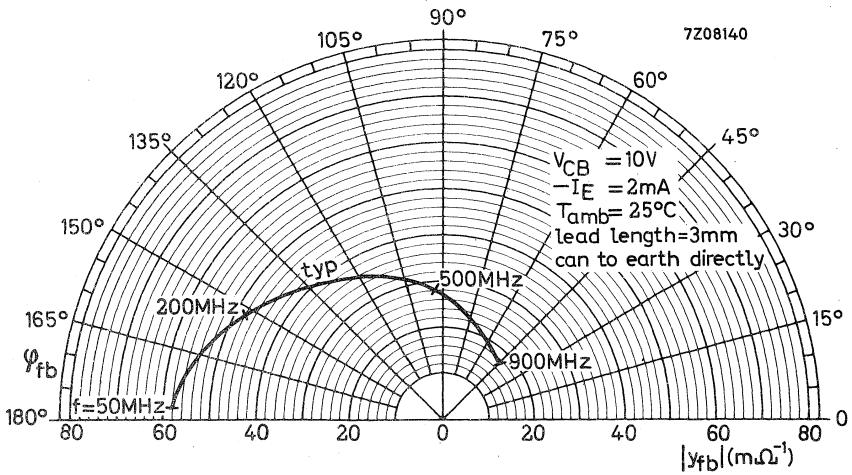
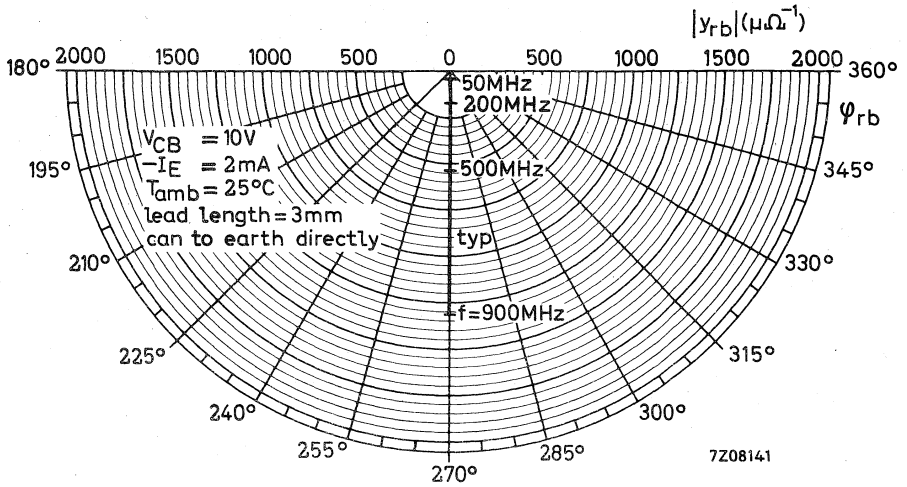

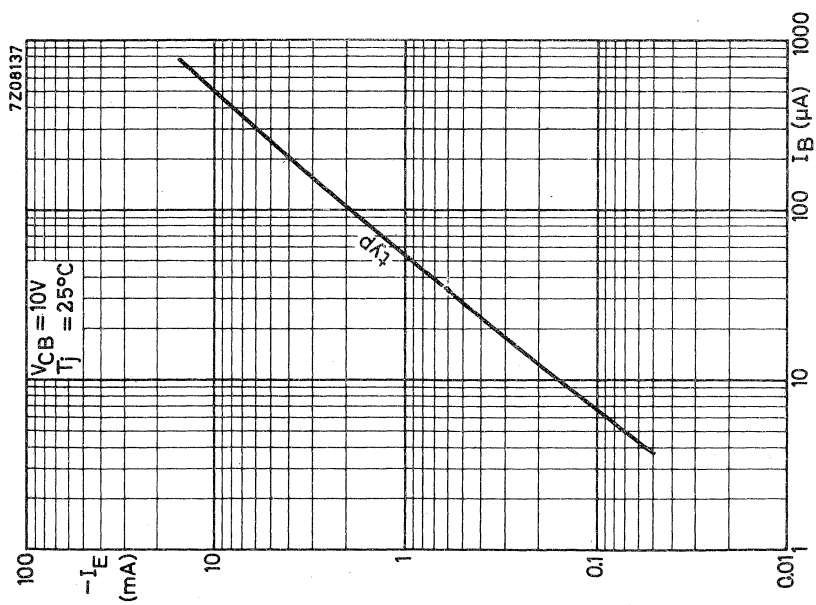
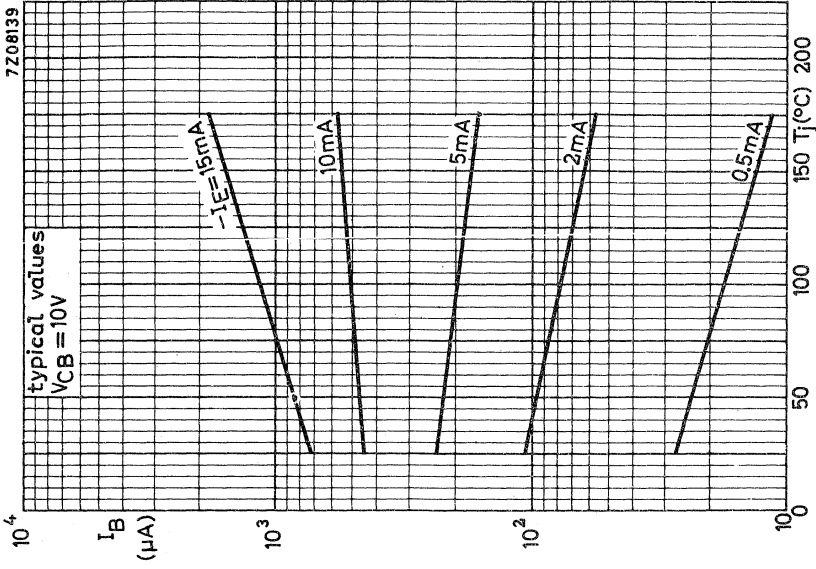

U.H.F. SILICON PLANAR TRANSISTOR

N-P-N transistor in a TO-72 metal envelope with insulated electrodes and a shield lead connected to the case. The BF183 is primarily intended for application in integrated television tuners as local oscillator with excellent frequency stability.

| QUICK REFERENCE DATA | | | |
|--|-----------|------|----------------------|
| Collector-base voltage (open emitter) | V_{CBO} | max. | 25 V |
| Collector-emitter voltage (open base) | V_{CEO} | max. | 20 V |
| Collector current (d.c.) | I_C | max. | 15 mA |
| Total power dissipation up to $T_{amb} = 25\text{ }^\circ\text{C}$ | P_{tot} | max. | 150 mW |
| Junction temperature | T_j | max. | 175 $^\circ\text{C}$ |
| Transition frequency | f_T | typ. | 800 MHz |
| $I_C = 3\text{ mA}; V_{CE} = 10\text{ V}$ | | | |
| Max. unilateralised power gain | | | |
| $-I_E = 3\text{ mA}; V_{CB} = 10\text{ V}; f = 900\text{ MHz}$ | GUM | typ. | 13 dB |

MECHANICAL DATA

Dimensions in mm

TO-72

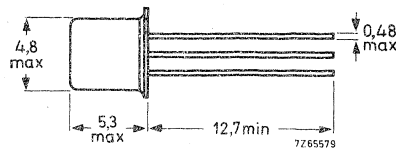
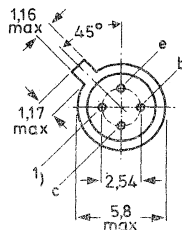

Accessories on request: 56246, 56263.

1) Shield lead connected to case.

RATINGS (Limiting values) ¹⁾Voltages

| | | | |
|---------------------------------------|-----------|------|------|
| Collector-base voltage (open emitter) | V_{CBO} | max. | 25 V |
| Collector-emitter voltage (open base) | V_{CEO} | max. | 20 V |
| Emitter-base voltage (open collector) | V_{EBO} | max. | 3 V |

Currents

| | | | |
|--------------------------------|----------|------|-------|
| Collector current (d.c.) | I_C | max. | 15 mA |
| Collector current (peak value) | I_{CM} | max. | 15 mA |

Power dissipation

| | | | |
|--|-----------|------|--------|
| Total power dissipation up to $T_{amb} = 25\text{ }^{\circ}\text{C}$ | P_{tot} | max. | 150 mW |
|--|-----------|------|--------|

Temperatures

| | | | |
|----------------------|-----------|-------------|------------------------|
| Storage temperature | T_{stg} | -65 to +175 | $^{\circ}\text{C}$ |
| Junction temperature | T_j | max. | 175 $^{\circ}\text{C}$ |

THERMAL RESISTANCE

| | | | |
|--------------------------------------|---------------|---|--------------------------------|
| From junction to ambient in free air | $R_{th\ j-a}$ | = | 1 $^{\circ}\text{C}/\text{mW}$ |
|--------------------------------------|---------------|---|--------------------------------|

¹⁾ Limiting values according to the Absolute Maximum System as defined in IEC publication 134.

CHARACTERISTICS

$T_{amb} = 25\text{ }^{\circ}\text{C}$ unless otherwise specified

Base-current

$-I_E = 3\text{ mA}; V_{CB} = 10\text{ V}$ I_B typ. 125 μA
 $< 300\text{ } \mu\text{A}$

Emitter-base voltage ¹⁾

$-I_E = 3\text{ mA}; V_{CB} = 10\text{ V}$ $-V_{EB}$ typ. 770 mV

Transition frequency

$I_C = 3\text{ mA}; V_{CE} = 10\text{ V}$ f_T typ. 800 MHz

Feedback capacitance at $f = 10.7\text{ MHz}$

$I_C = 1\text{ mA}; V_{CE} = 10\text{ V}$ C_{re} typ. 330 fF

Transducer gain at $f = 900\text{ MHz}$ (common base) ²⁾

$-I_E = 3\text{ mA}; V_{CB} = 10\text{ V}$
 $G_S = 20\text{ m}\Omega^{-1}; G_L = 2\text{ m}\Omega^{-1}$ G_{tr} $> 8.5\text{ dB}$
 typ. 12 dB

Max. unilateralised power gain

$$G_{UM} = \frac{|y_{fb}|^2}{4 g_{ib}g_{ob}}$$

$-I_E = 3\text{ mA}; V_{CB} = 10\text{ V}; f = 500\text{ MHz}$ G_{UM} typ. 16 dB

$-I_E = 3\text{ mA}; V_{CB} = 10\text{ V}; f = 900\text{ MHz}$ G_{UM} typ. 13 dB

1) $-V_{EB}$ decreases by about 1.6 mV/ $^{\circ}\text{C}$ with increasing temperature.

2) Envelope connected to earth directly, lead length = 3 mm.

APPLICATION INFORMATION

Oscillator circuit with simplified mixer stage

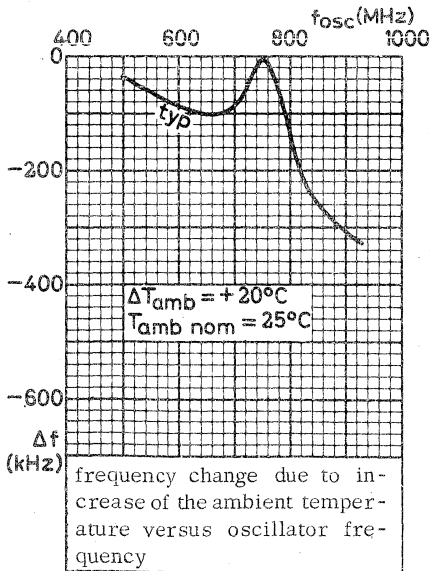
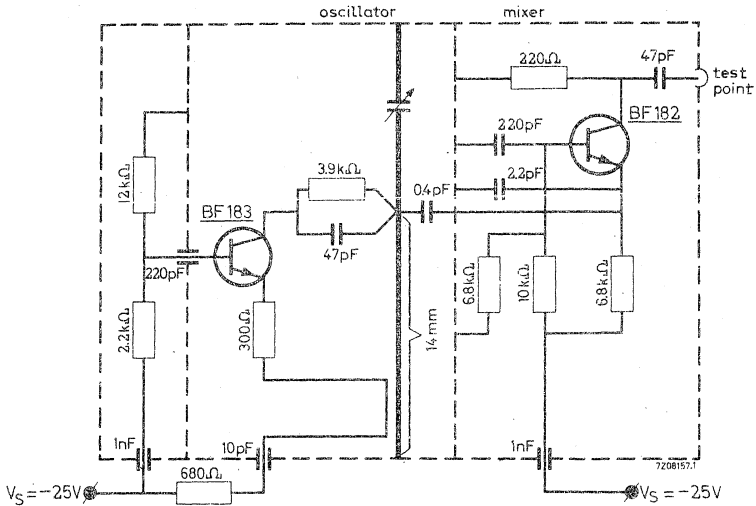

7208145

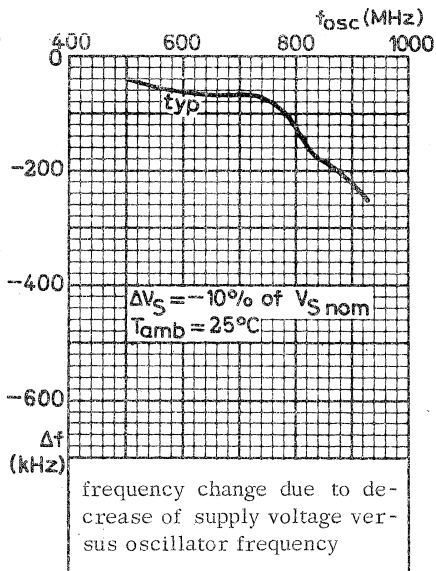

7208147

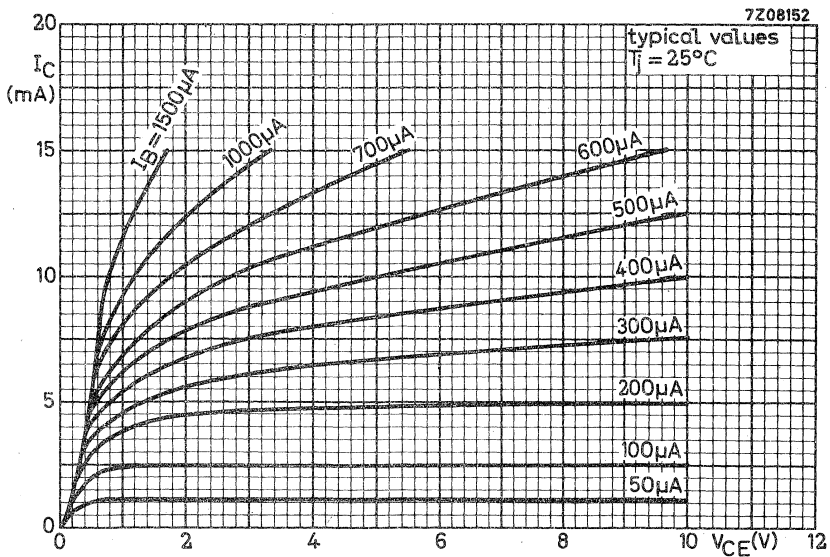
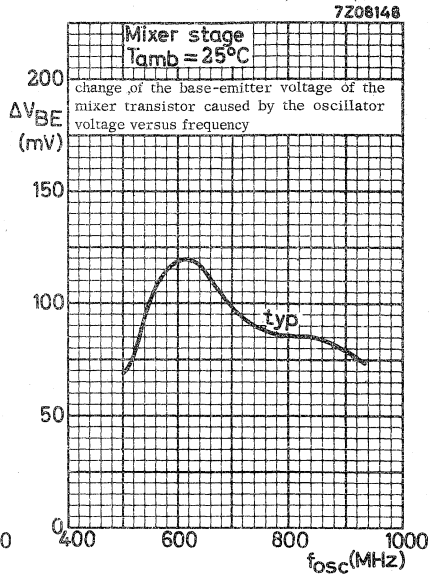
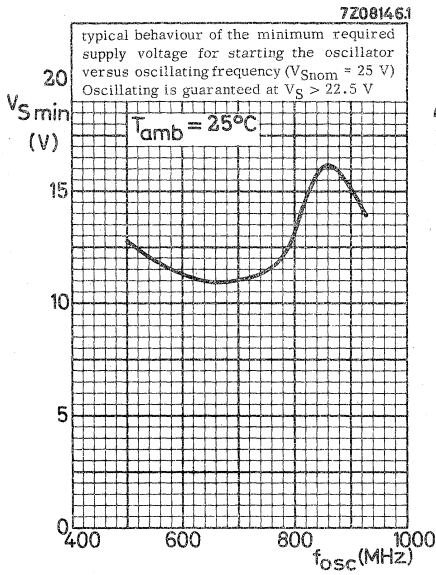

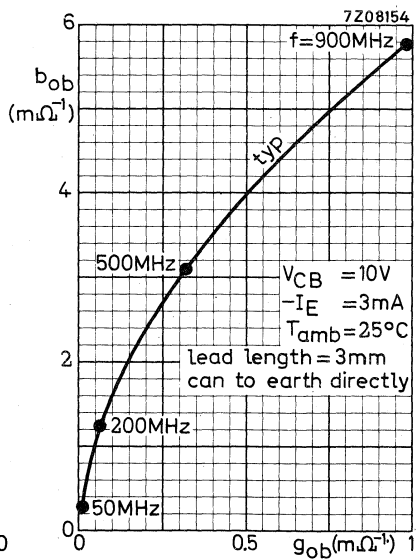
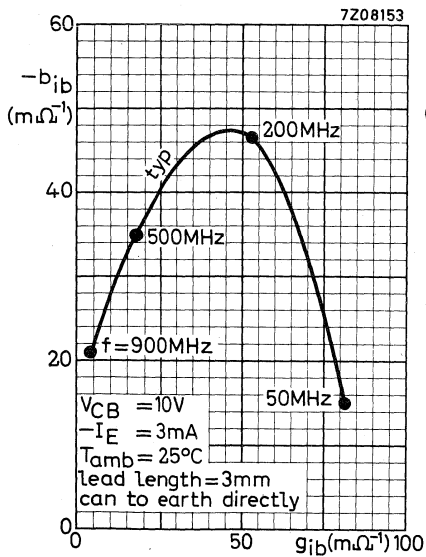
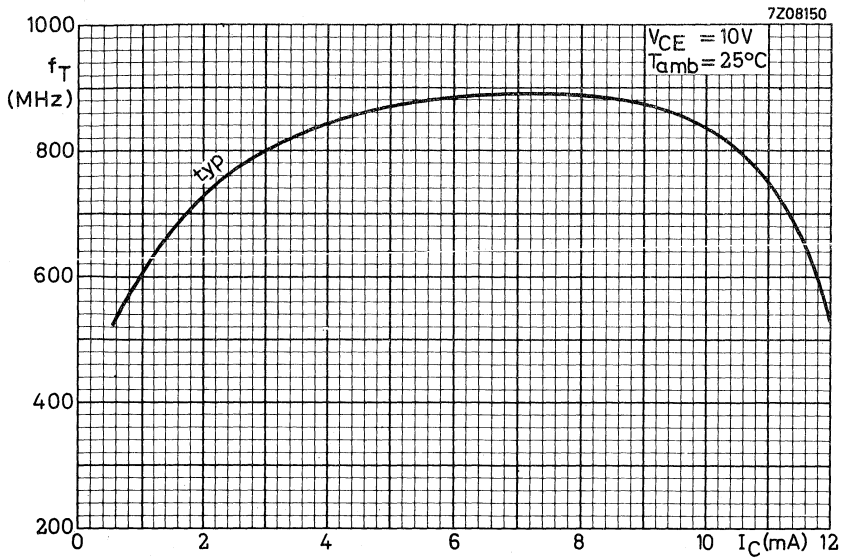

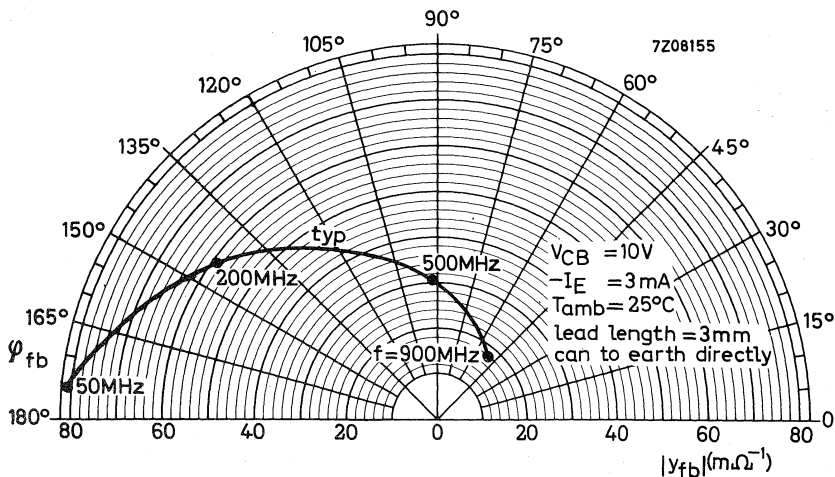
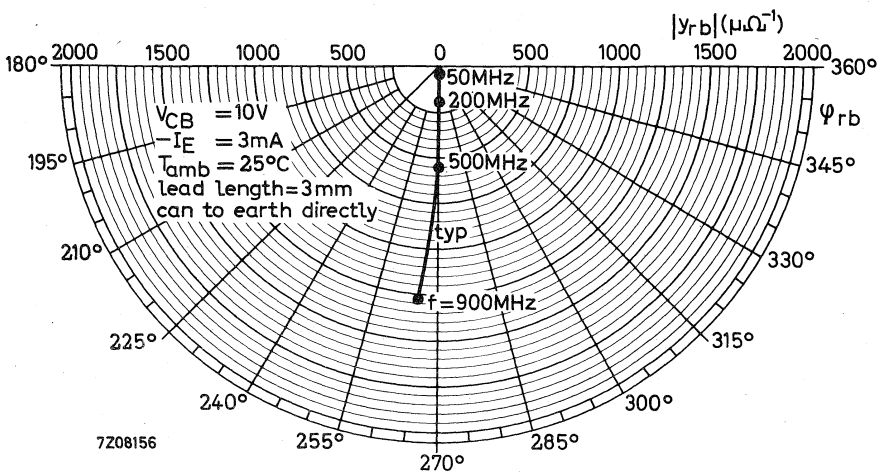

|||||

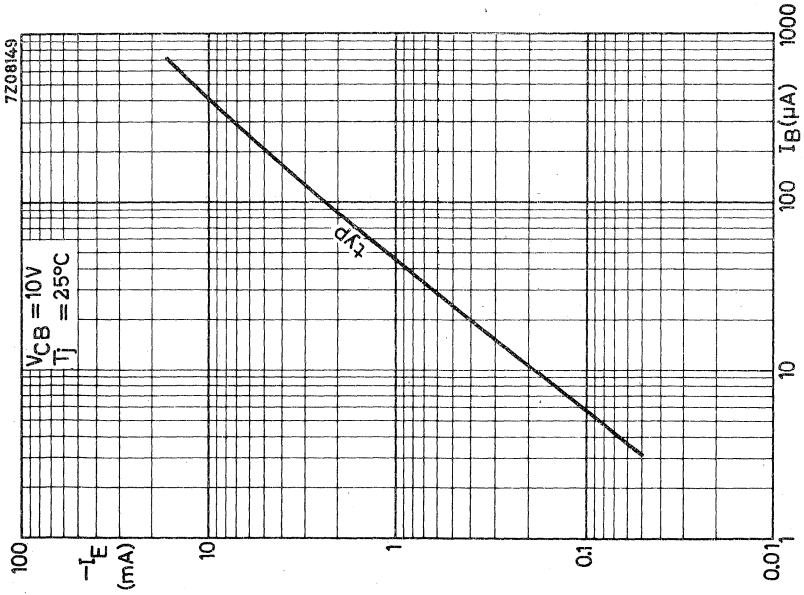
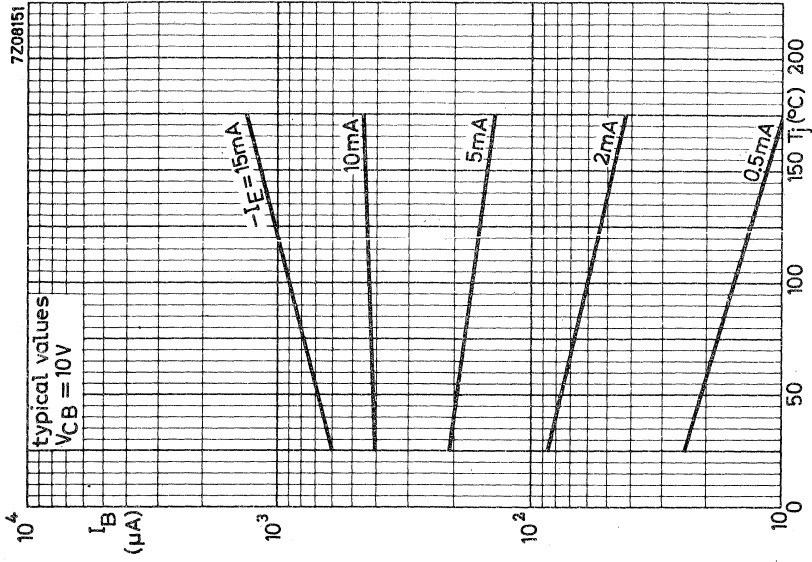

SILICON PLANAR EPITAXIAL TRANSISTOR

N-P-N transistor in a TO-72 metal case intended for h. f. applications in radio and television receivers.

It is especially recommended for f. m. tuners, low noise a. m. mixer-oscillators with high source impedance and i. f. amplifiers in a. m. /f. m. receivers where a high current gain is of importance.

QUICK REFERENCE DATA

| | | | | |
|---|-----------|------|-----|------------------|
| Collector-base voltage (open emitter) | V_{CBO} | max. | 30 | V |
| Collector-emitter voltage (open base) | V_{CEO} | max. | 20 | V |
| Collector current (d. c.) | I_C | max. | 30 | mA |
| Total power dissipation up to $T_{amb} = 45\text{ }^\circ\text{C}$ | P_{tot} | max. | 145 | mW |
| Junction temperature | T_j | max. | 175 | $^\circ\text{C}$ |
| D. C. current gain at $T_j = 25\text{ }^\circ\text{C}$ $I_C = 1\text{ mA}; V_{CE} = 10\text{ V}$ | h_{FE} | typ. | 115 | |
| Transition frequency $I_C = 1\text{ mA}; V_{CE} = 10\text{ V}$ | f_T | typ. | 300 | MHz |

MECHANICAL DATA

Dimensions in mm

TO-72

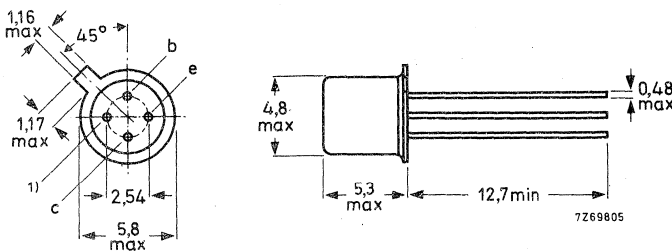

1) = shield lead (connected to case)

Accessories: 56246 (distance disc); 56263 (cooling fin).

FOR NEW DESIGN THE SUCCESSOR TYPE BF494 IS RECOMMENDED

RATINGS Limiting values in accordance with the Absolute Maximum System (IEC 134)

Voltages

| | | | |
|---|-----------|------|------|
| Collector-base voltage (open emitter) | V_{CBO} | max. | 30 V |
| Collector-emitter voltage (open base) (See also sheet 4) | V_{CEO} | max. | 20 V |
| Emitter-base voltage (open collector) | V_{EBO} | max. | 5 V |

Currents

| | | | |
|--------------------------------|----------|------|-------|
| Collector current (d.c.) | I_C | max. | 30 mA |
| Collector current (peak value) | I_{CM} | max. | 30 mA |

Power dissipation

| | | | |
|--|-----------|------|--------|
| Total power dissipation up to $T_{amb} = 45\text{ }^\circ\text{C}$ | P_{tot} | max. | 145 mW |
|--|-----------|------|--------|

Temperatures

| | | | |
|----------------------|-----------|-------------|----------------------|
| Storage temperature | T_{stg} | -65 to +175 | $^\circ\text{C}$ |
| Junction temperature | T_j | max. | 175 $^\circ\text{C}$ |

THERMAL RESISTANCE

| | | | |
|--------------------------------------|---------------|---|--------------------------------|
| From junction to ambient in free air | $R_{th\ j-a}$ | = | 0.9 $^\circ\text{C}/\text{mW}$ |
|--------------------------------------|---------------|---|--------------------------------|

CHARACTERISTICS

$T_j = 25\text{ }^\circ\text{C}$ unless otherwise specified

Base-emitter voltage 1)

$I_C = 1\text{ mA}; V_{CE} = 10\text{ V}$
 $I_C = 20\text{ mA}; V_{CE} = 2\text{ V}$

| | | |
|----------|--------------|-------|
| V_{BE} | 0.65 to 0.74 | V |
| V_{BE} | < | 1.0 V |

Feedback capacitance at $f = 0.45\text{ MHz}$

$I_C = 1\text{ mA}; V_{CE} = 10\text{ V}$

| | | |
|----------|------|---------|
| C_{re} | typ. | 0.65 pF |
|----------|------|---------|

D.C. current gain

$I_C = 1\text{ mA}; V_{CE} = 10\text{ V}$

| | |
|----------|-----------|
| h_{FE} | 75 to 750 |
| | typ. 115 |

Transition frequency

$I_C = 1\text{ mA}; V_{CE} = 10\text{ V}$

| | | |
|-------|------|---------|
| f_T | typ. | 300 MHz |
|-------|------|---------|

Conversion noise figure

$I_C = 1\text{ mA}; V_{CE} = 10\text{ V}$
 $G_S = 0.6\text{ mA/V}; f = 0.2\text{ MHz}$
 $G_S = 1.2\text{ mA/V}; f = 1.0\text{ MHz}$

| | | |
|-------|------|------|
| F_C | typ. | 3 dB |
| F_C | typ. | 2 dB |

1) V_{BE} decreases with about 1.7 mV/ $^\circ\text{C}$ at increasing temperature.

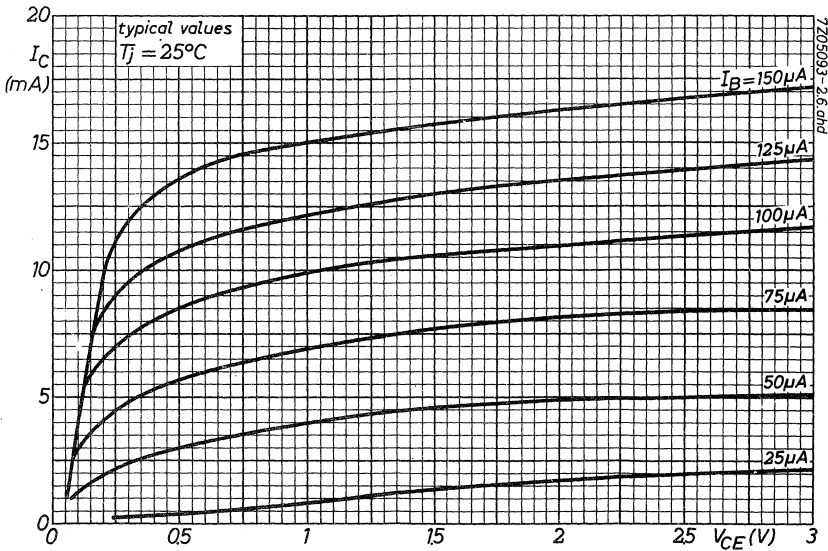
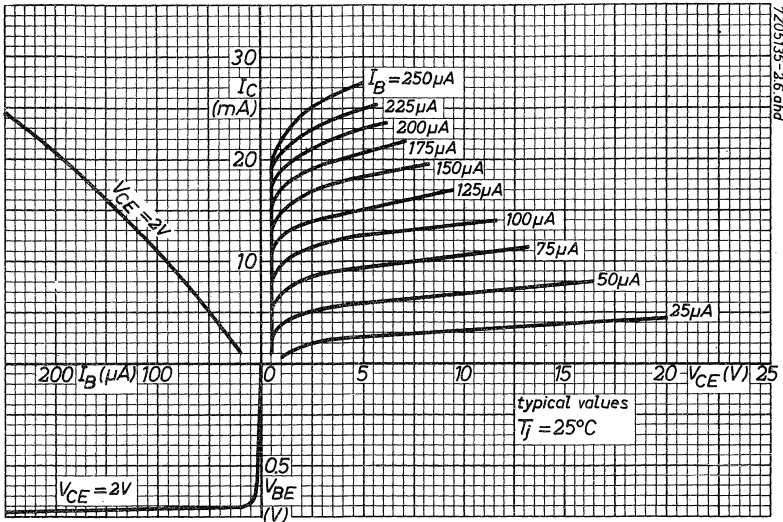

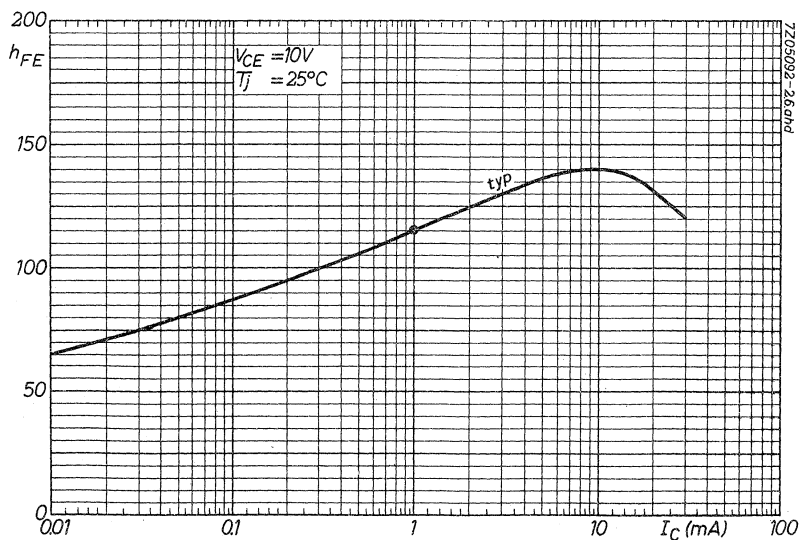
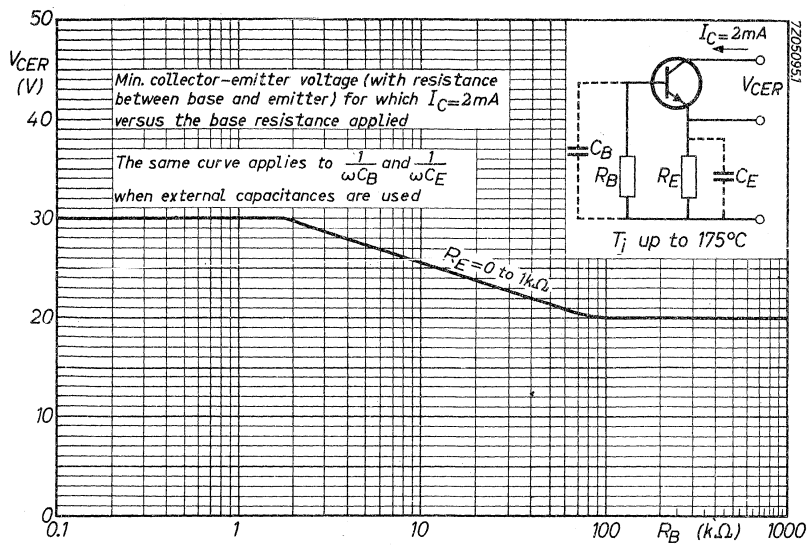

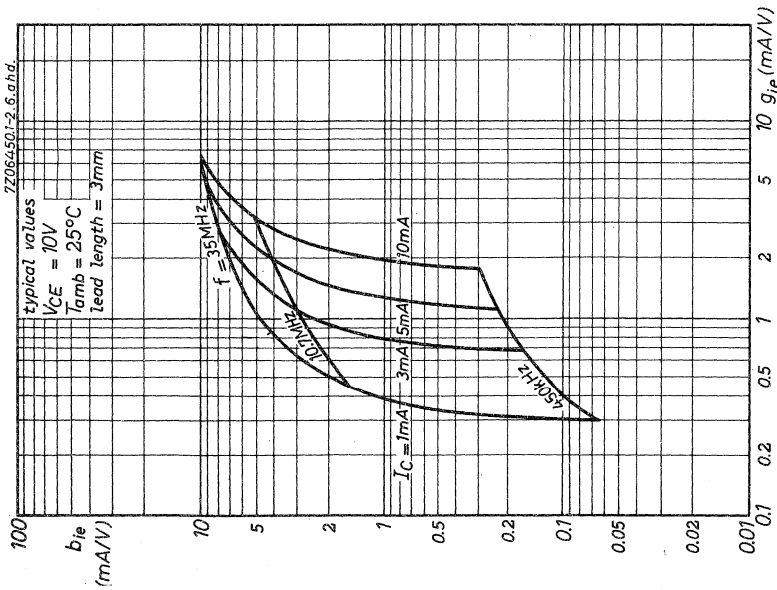
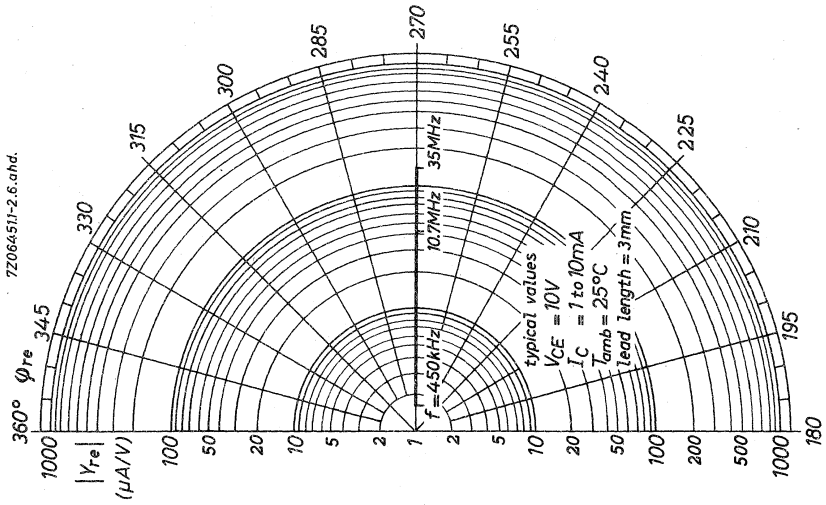

88888888

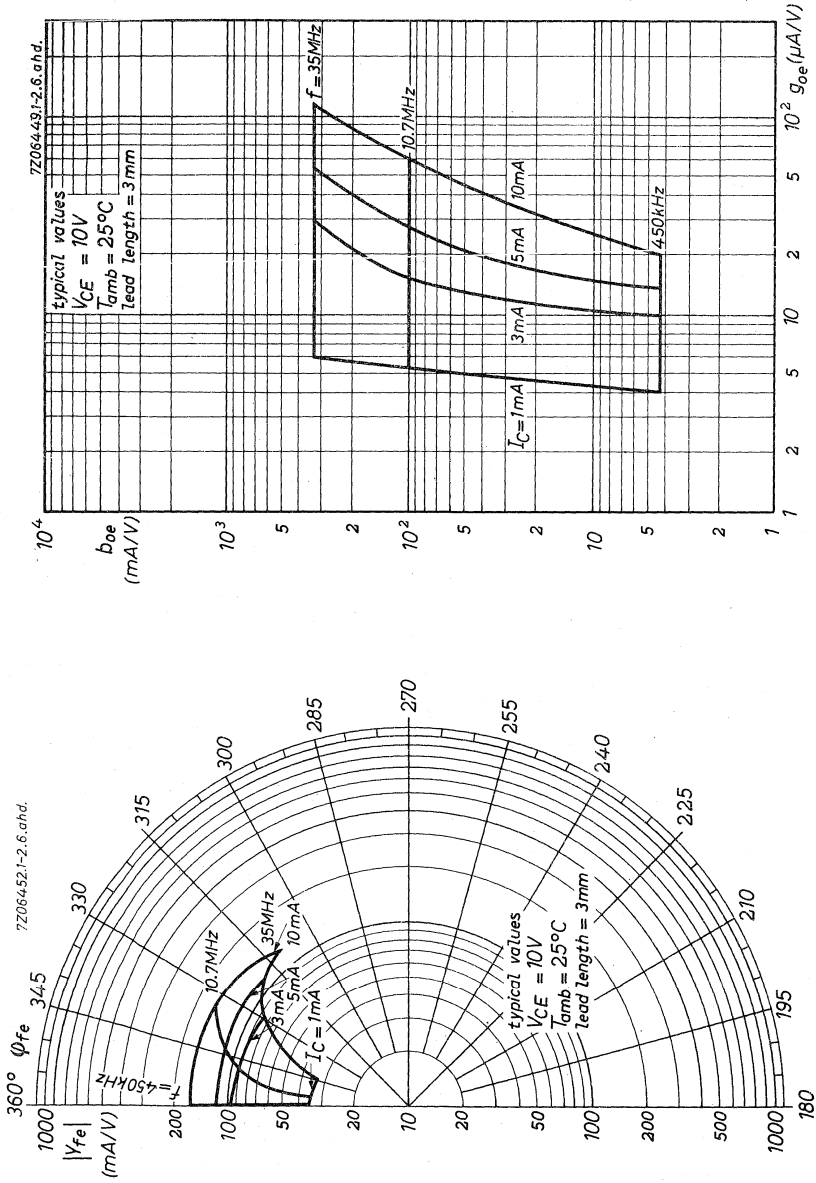

SILICON PLANAR EPITAXIAL TRANSISTOR

N-P-N transistor in a TO-72 metal case intended for h.f. applications in radio and television receivers.

It is especially recommended for f. m. tuners, i. f. amplifiers in a. m. /f. m receivers where a low transistor output conductance is of importance, a. m. input stages of car-radios where a low noise figure at low source impedance is required.

QUICK REFERENCE DATA

| | | | | |
|---|-----------|------|-----|------------------|
| Collector-base voltage (open emitter) | V_{CBO} | max. | 30 | V |
| Collector-emitter voltage (open base) | V_{CEO} | max. | 20 | V |
| Collector current (d. c.) | I_C | max. | 30 | mA |
| Total power dissipation up to $T_{amb} = 45\text{ }^\circ\text{C}$ | P_{tot} | max. | 145 | mW |
| Junction temperature | T_j | max. | 175 | $^\circ\text{C}$ |
| D. C. current gain at $T_j = 25\text{ }^\circ\text{C}$ $I_C = 1\text{ mA}; V_{CE} = 10\text{ V}$ | h_{FE} | typ. | 67 | |
| Transition frequency $I_C = 1\text{ mA}; V_{CE} = 10\text{ V}$ | f_T | typ. | 220 | MHz |
| Noise figure at $f = 100\text{ MHz}$ $I_C = 1\text{ mA}; V_{CE} = 10\text{ V}; G_S = 10\text{ mA/V}$ | F | typ. | 4 | dB |

MECHANICAL DATA

Dimensions in mm

TO-72

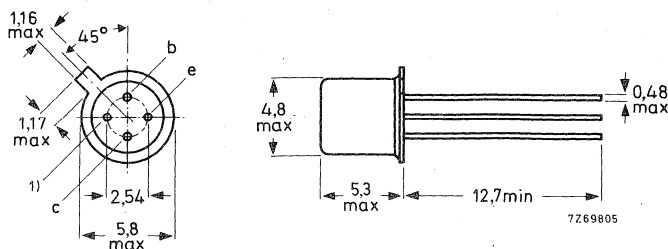

1) = shield lead (connected to case)

Accessories: 56246, 56263.

FOR NEW DESIGN THE SUCCESSOR TYPE BF495 IS RECOMMENDED

RATINGS Limiting values in accordance with the Absolute Maximum System (IEC 134)

Voltages

| | | | |
|---|-----------|------|------|
| Collector-base voltage (open emitter) | V_{CBO} | max. | 30 V |
| Collector-emitter voltage (open base) (See also sheet 8) | V_{CEO} | max. | 20 V |
| Emitter-base voltage (open collector) | V_{EBO} | max. | 5 V |

Currents

| | | | |
|--------------------------------|----------|------|-------|
| Collector current (d.c.) | I_C | max. | 30 mA |
| Collector current (peak value) | I_{CM} | max. | 30 mA |

Power dissipation

| | | | |
|--|-----------|------|--------|
| Total power dissipation up to $T_{amb} = 45\text{ }^\circ\text{C}$ | P_{tot} | max. | 145 mW |
|--|-----------|------|--------|

Temperatures

| | | | |
|----------------------|-----------|-------------|----------------------|
| Storage temperature | T_{stg} | -65 to +175 | $^\circ\text{C}$ |
| Junction temperature | T_j | max. | 175 $^\circ\text{C}$ |

THERMAL RESISTANCE

| | | | |
|--------------------------------------|---------------|---|--------------------------------|
| From junction to ambient in free air | $R_{th\ j-a}$ | = | 0.9 $^\circ\text{C}/\text{mW}$ |
|--------------------------------------|---------------|---|--------------------------------|

CHARACTERISTICS

$T_j = 25\text{ }^\circ\text{C}$ unless otherwise specified

Base-emitter voltage ¹⁾

| | | | |
|---|----------|--------------|-------|
| $I_C = 1\text{ mA}; V_{CE} = 10\text{ V}$ | V_{BE} | 0.65 to 0.74 | V |
| $I_C = 20\text{ mA}; V_{CE} = 2\text{ V}$ | V_{BE} | < | 1.0 V |

Feedback capacitance at $f = 0.45\text{ MHz}$

| | | | |
|---|----------|------|---------|
| $I_C = 1\text{ mA}; V_{CE} = 10\text{ V}$ | C_{re} | typ. | 0.65 pF |
|---|----------|------|---------|

D.C. current gain

| | | |
|---|----------|-----------|
| $I_C = 1\text{ mA}; V_{CE} = 10\text{ V}$ | h_{FE} | 34 to 140 |
| | | typ. 67 |

Transition frequency

| | | | |
|---|-------|------|---------|
| $I_C = 1\text{ mA}; V_{CE} = 10\text{ V}$ | f_T | typ. | 220 MHz |
|---|-------|------|---------|

¹⁾ V_{BE} decreases with about 1.7 mV/ $^\circ\text{C}$ at increasing temperature.

CHARACTERISTICS (continued)

$T_j = 25\text{ }^\circ\text{C}$ unless otherwise specified

Noise figure

$I_C = 1\text{ mA}; V_{CE} = 10\text{ V}$

$f = 0,2\text{ MHz}; G_S = 5\text{ mA/V}$ F typ. 2 dB

$f = 1\text{ MHz}; G_S = 20\text{ mA/V}$ F typ. 3,5 dB

$f = 100\text{ MHz}; G_S = 10\text{ mA/V}$ F typ. 4 dB

y parameters at $f = 100\text{ MHz}$ (common base)

$-I_E = 1\text{ mA}; V_{CB} = 10\text{ V}$

Input conductance g_{ib} typ. 33 mA/V

Input capacitance $-C_{ib}$ typ. 5,5 pF

Feedback admittance $|y_{rb}|$ typ. 220 mA/V

Phase angle of feedback admittance φ_{rb} typ. 273°

Transfer admittance $|y_{fb}|$ typ. 33 mA/V

Phase angle of transfer admittance φ_{fb} typ. 150°

Output conductance g_{ob} typ. 12 $\mu\text{A/V}$ ←

Output capacitance C_{ob} typ. 1,5 pF

NOTE

All small-signal quantities have been measured with a length of leads between the bottom of the transistor and measuring jig of 3 mm.

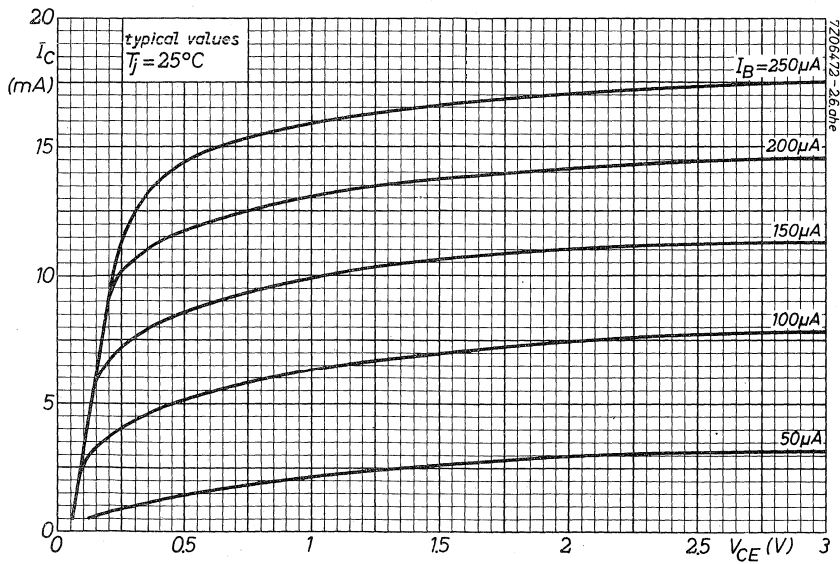
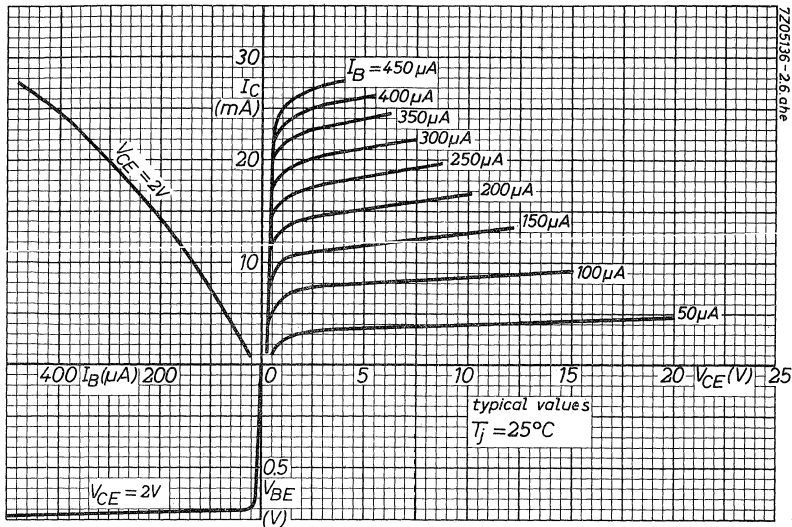

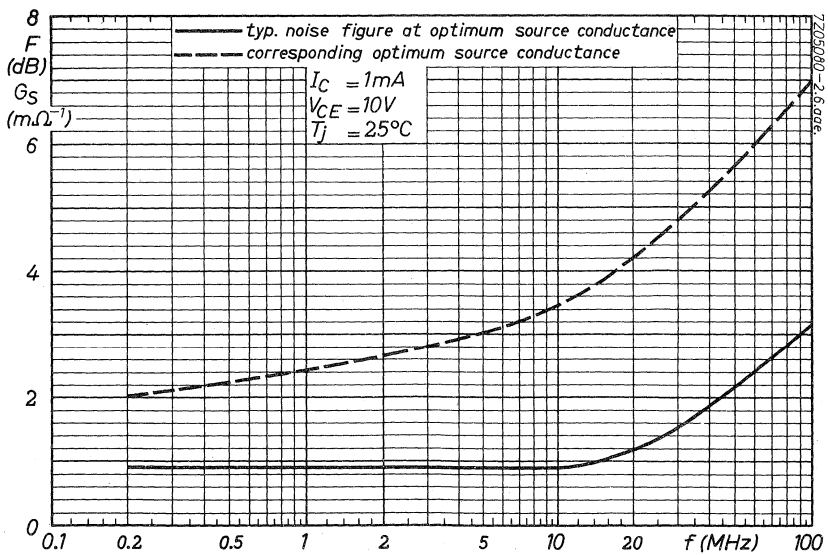
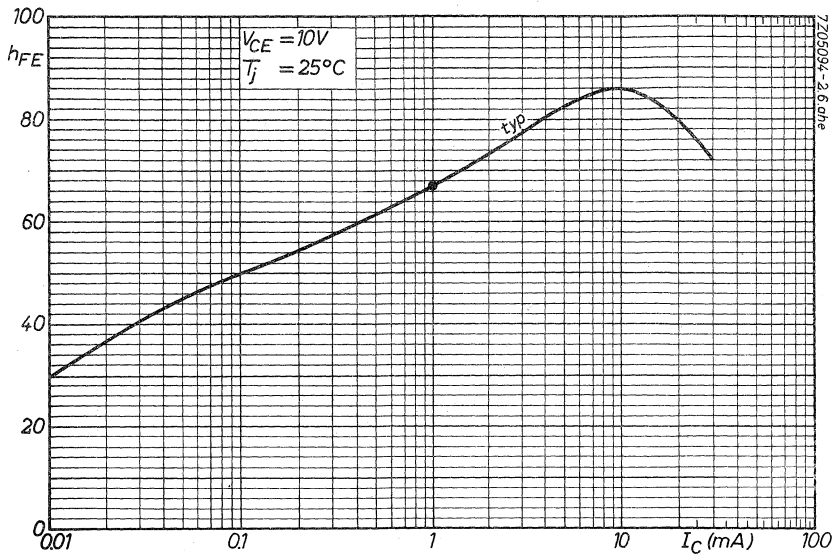

|||||

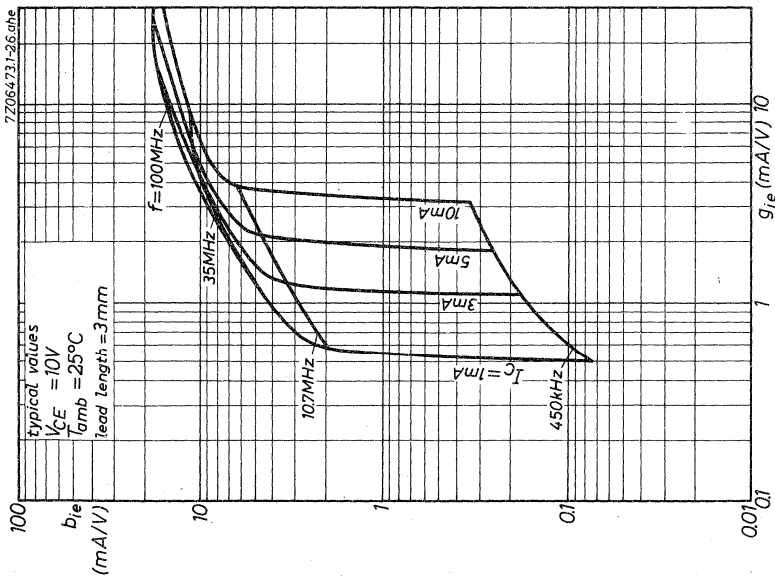
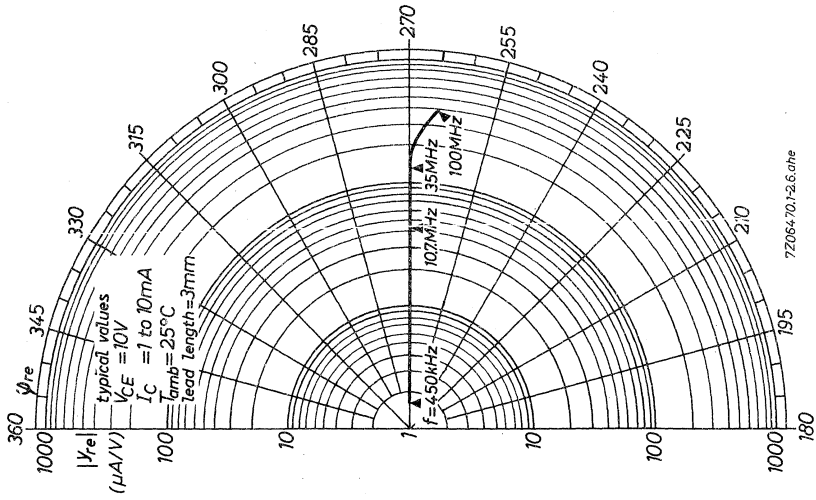

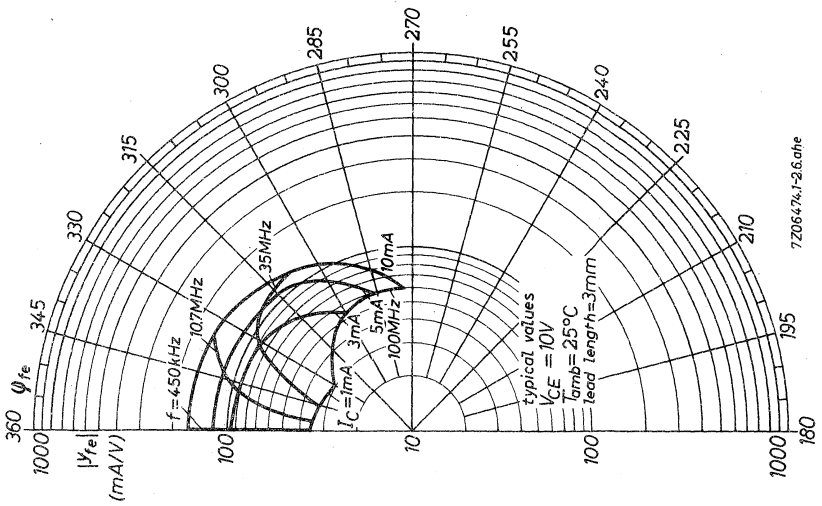
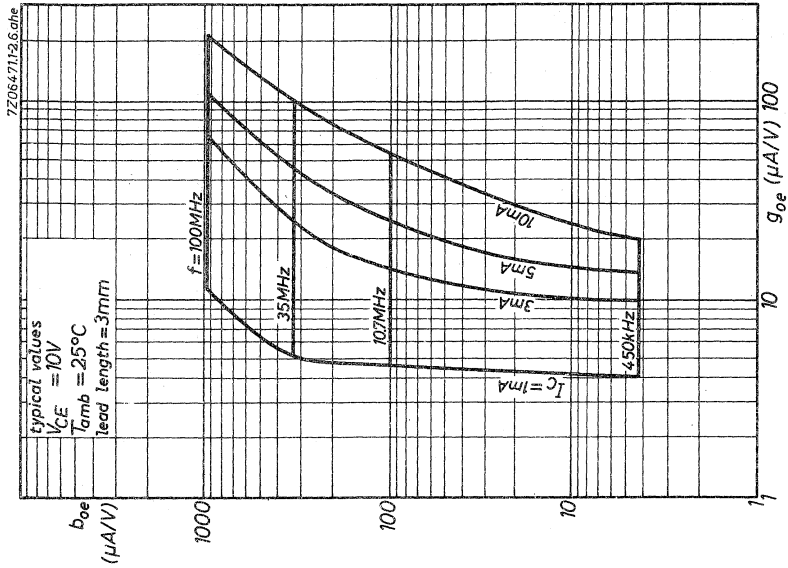

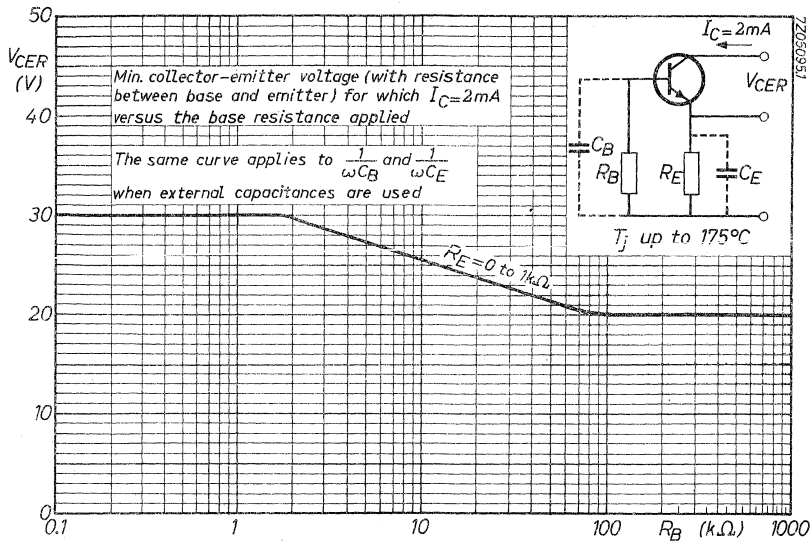

SILICON PLANAR EPITAXIAL TRANSISTOR

N-P-N transistor in a plastic envelope with stiff, self-locking pins suitable for use with standard printed boards.

The BF194 is intended for h.f. applications in radio and television receivers; it is especially recommended for f.m. tuners, low noise a.m. mixer-oscillators with high source impedance and i.f. amplifiers in a.m./f.m. receivers where a high current gain is of importance.

QUICK REFERENCE DATA

| | | | |
|---|-----------|------|----------------------|
| Collector-base voltage (open emitter) | V_{CBO} | max. | 30 V |
| Collector-emitter voltage (open base) | V_{CEO} | max. | 20 V |
| Collector current (d.c.) | I_C | max. | 30 mA |
| Total power dissipation up to $T_{amb} = 25^\circ\text{C}$ | P_{tot} | max. | 250 mW |
| Junction temperature | T_j | max. | 125 $^\circ\text{C}$ |
| D.C. current gain at $T_j = 25^\circ\text{C}$ $I_C = 1\text{ mA}; V_{CE} = 10\text{ V}$ | h_{FE} | typ. | 115 |
| Transition frequency $I_C = 1\text{ mA}; V_{CE} = 10\text{ V}$ | f_T | typ. | 260 MHz |
| Noise figure at $f = 100\text{ MHz}$ $I_C = 1\text{ mA}; V_{CE} = 10\text{ V}; G_S = 10\text{ m}\Omega^{-1}$ | F | typ. | 4 dB |
| Conversion noise figure at $f = 1\text{ MHz}$ $I_C = 1\text{ mA}; V_{CE} = 10\text{ V}; G_S = 1.2\text{ m}\Omega^{-1}$ | F_c | typ. | 2 dB |

MECHANICAL DATA

Dimensions in mm

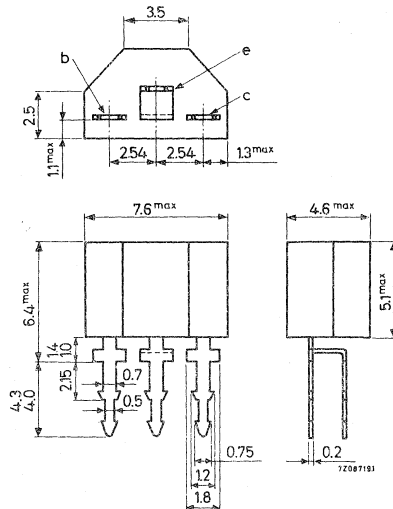

MOUNTING INSTRUCTIONS

1. Thickness of printed board: max. 1.1 mm
Hole diameter 0.77 to 0.83 mm
2. Thickness of printed board: max. 1.7 mm
Hole diameter 1.25 to 1.35 mm



Bore plan

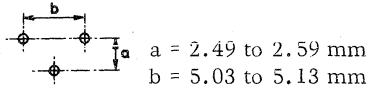

RATINGS Limiting values in accordance with the Absolute Maximum System (IEC 134)

Voltages

| | | | |
|--|-----------|------|------|
| Collector-base voltage (open emitter) | V_{CBO} | max. | 30 V |
| Collector-emitter voltage (open base) (See also page 4) | V_{CEO} | max. | 20 V |
| Emitter-base voltage (open collector) | V_{EBO} | max. | 5 V |

Currents

| | | | |
|--------------------------------|----------|------|-------|
| Collector current (d.c.) | I_C | max. | 30 mA |
| Collector current (peak value) | I_{CM} | max. | 30 mA |

Power dissipation

| | | | |
|---|-----------|------|--------|
| Total power dissipation up to $T_{amb} = 25 \text{ }^\circ\text{C}$ | P_{tot} | max. | 250 mW |
|---|-----------|------|--------|

Temperatures

| | | | |
|----------------------|-----------|-------------|----------------------|
| Storage temperature | T_{stg} | -65 to +125 | $^\circ\text{C}$ |
| Junction temperature | T_j | max. | 125 $^\circ\text{C}$ |

THERMAL RESISTANCE

| | | | |
|--------------------------------------|----------------------|---|-------------------------|
| From junction to ambient in free air | $R_{th \text{ j-a}}$ | = | 0.4 $^\circ\text{C/mW}$ |
|--------------------------------------|----------------------|---|-------------------------|

CHARACTERISTICS

$T_j = 25\text{ }^\circ\text{C}$

Base-emitter voltage V_{BE}

$I_C = 1\text{ mA}; V_{CE} = 10\text{ V}$ V_{BE} 0.65 to 0.74 V

Base current I_B

$I_C = 1\text{ mA}; V_{CE} = 10\text{ V}$ I_B 4.5 to 15 μA
typ. 8.7 μA

Feedback capacitance at $f = 0.45\text{ MHz}$

$I_C = 1\text{ mA}; V_{CE} = 10\text{ V}$ C_{re} typ. 0.95 pF

Transition frequency f_T

$I_C = 1\text{ mA}; V_{CE} = 10\text{ V}$ f_T typ. 260 MHz

Noise figure

$I_C = 1\text{ mA}; V_{CE} = 10\text{ V}$

$G_S = 2\text{ m}\Omega^{-1}; f = 0.2\text{ MHz}$ F typ. 1.5 dB

$G_S = 1.5\text{ m}\Omega^{-1}; f = 1.0\text{ MHz}$ F typ. 1.2 dB

$G_S = 10\text{ m}\Omega^{-1}; f = 100\text{ MHz}$ F typ. 4 dB

Conversion noise figure

$I_C = 1\text{ mA}; V_{CE} = 10\text{ V}$

$G_S = 0.6\text{ m}\Omega^{-1}; f = 0.2\text{ MHz}$ F_C typ. 3 dB

$G_S = 1.2\text{ m}\Omega^{-1}; f = 1.0\text{ MHz}$ F_C typ. 2 dB

y parameters at $f = 100\text{ MHz}$ (common base)

$I_C = 1\text{ mA}; V_{CE} = 10\text{ V}$ (lead length = 3 mm)

| | | | | |
|------------------------------------|--|----------------|------|---------------------------|
| Input conductance | | g_{ib} | typ. | 36 $\text{m}\Omega^{-1}$ |
| Input susceptance | | $-b_{ib}$ | typ. | 3 $\text{m}\Omega^{-1}$ |
| Feedback admittance | | $ y_{rb} $ | typ. | 450 $\mu\Omega^{-1}$ |
| Phase angle of feedback admittance | | φ_{rb} | typ. | 272° |
| Transfer admittance | | $ y_{fb} $ | typ. | 33 $\text{m}\Omega^{-1}$ |
| Phase angle of transfer admittance | | φ_{fb} | typ. | 146° |
| Output conductance | | g_{ob} | typ. | 22 $\mu\Omega^{-1}$ |
| Output susceptance | | b_{ob} | typ. | 1.1 $\text{m}\Omega^{-1}$ |

y parameters (common emitter)

| | | |
|--|-----------------------|----------------------------|
| $I_C = 1\text{ mA}; V_{CE} = 10\text{ V}$ (lead length = 3 mm) | $f = 10.7\text{ MHz}$ | $f = 0.45\text{ MHz}$ |
| Input conductance | $g_{ie} < 0.64$ | 0.54 $\text{m}\Omega^{-1}$ |
| Output conductance | $g_{oe} < 13.5$ | 11.5 $\mu\Omega^{-1}$ |

1) V_{BE} decreases by about 1.7 mV/ $^\circ\text{C}$ with increasing temperature.

7Z08228.1

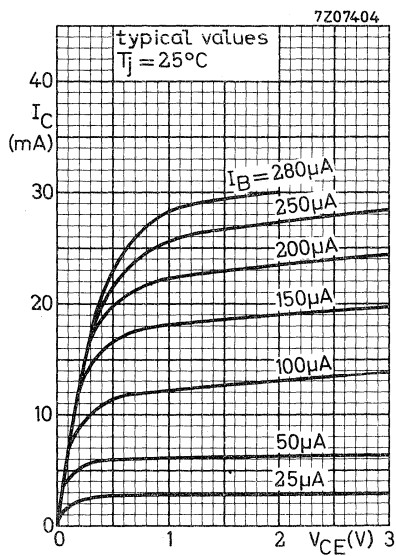
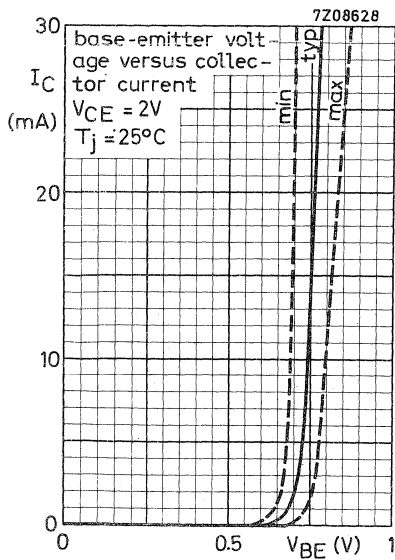
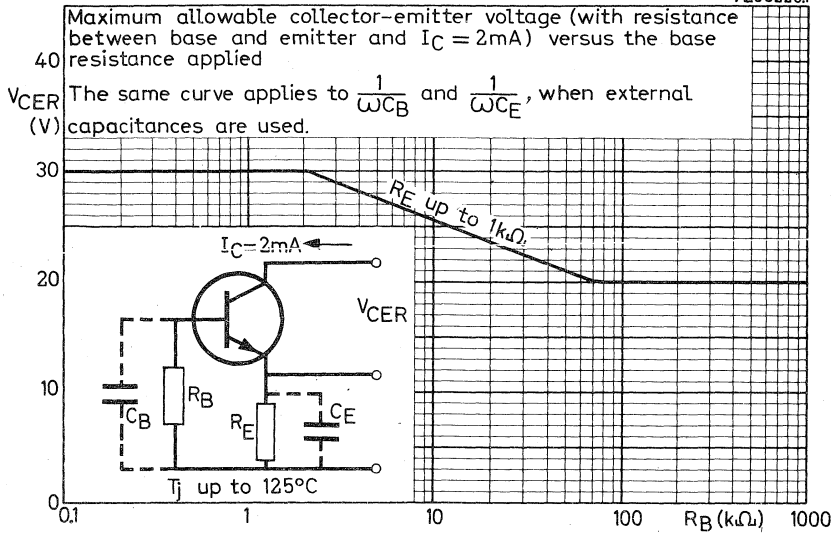

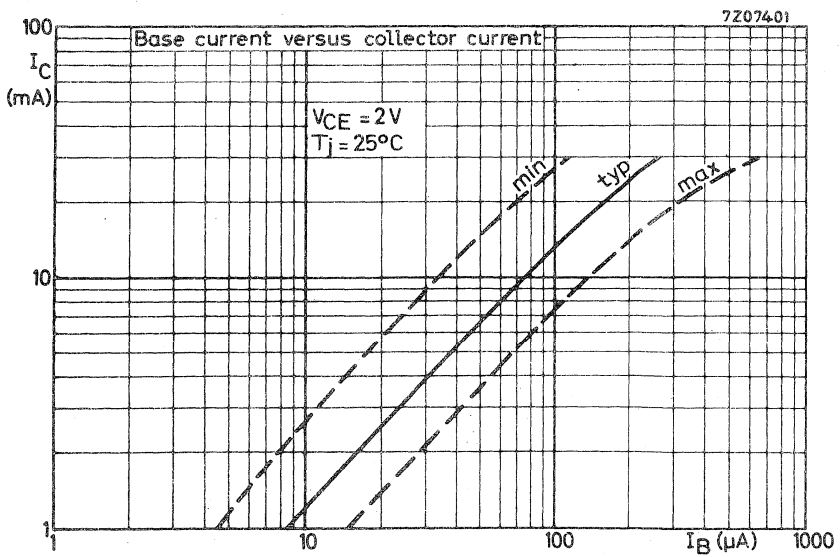
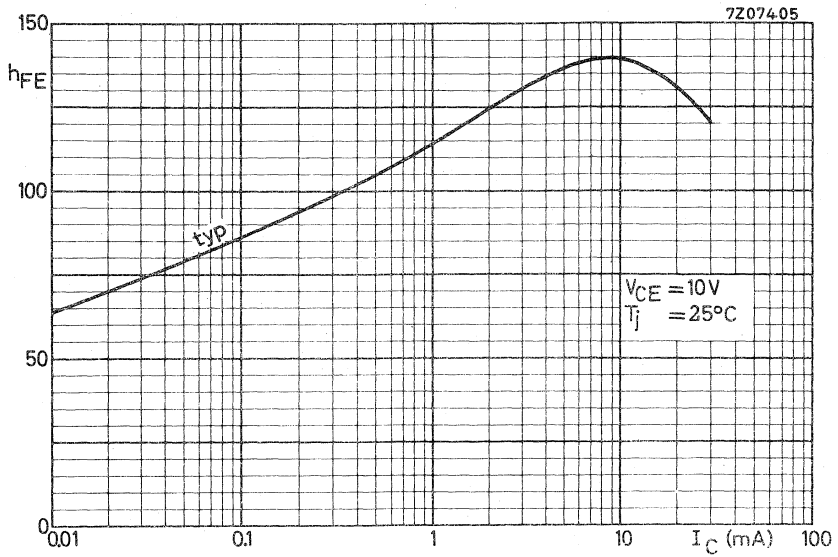

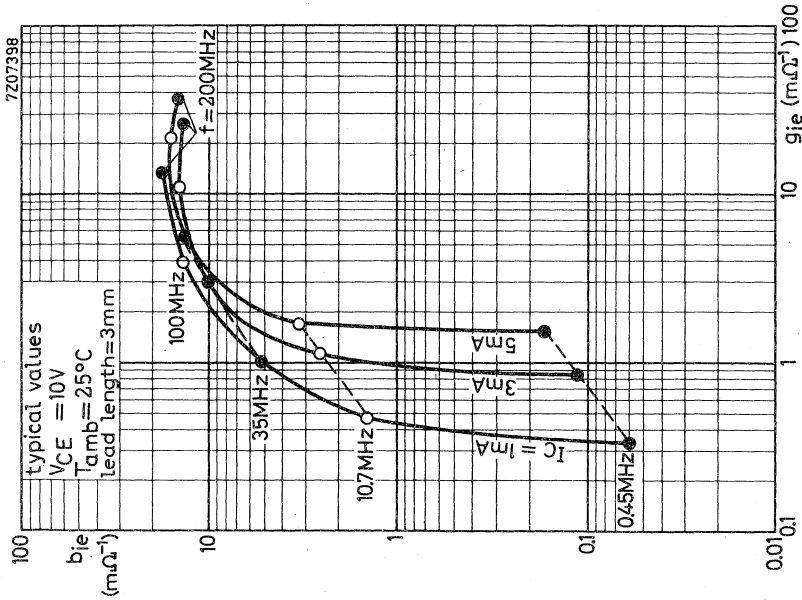
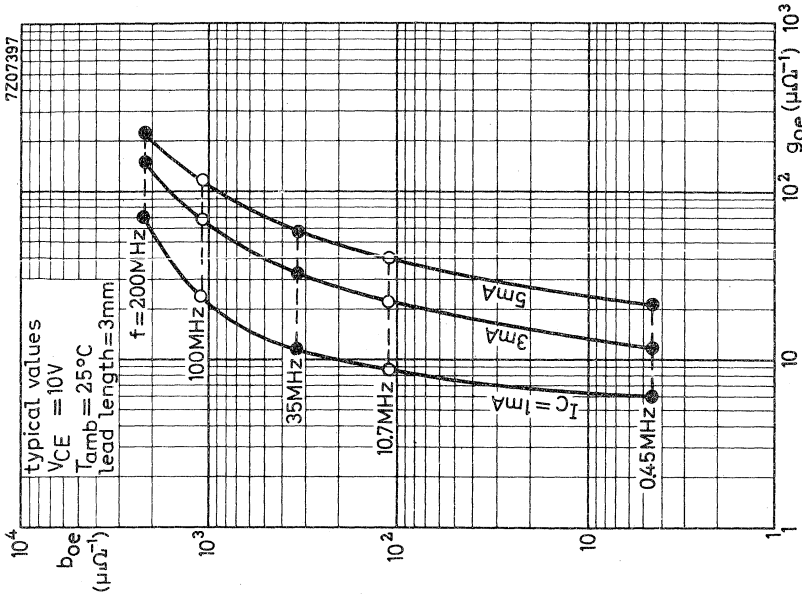

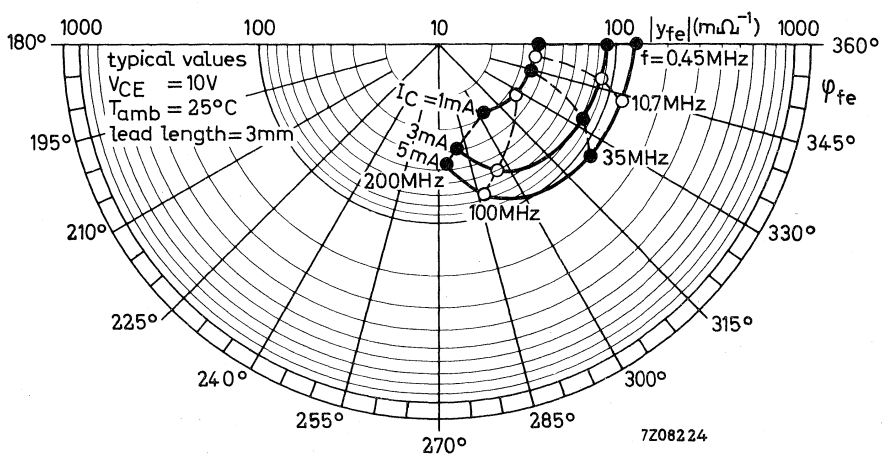
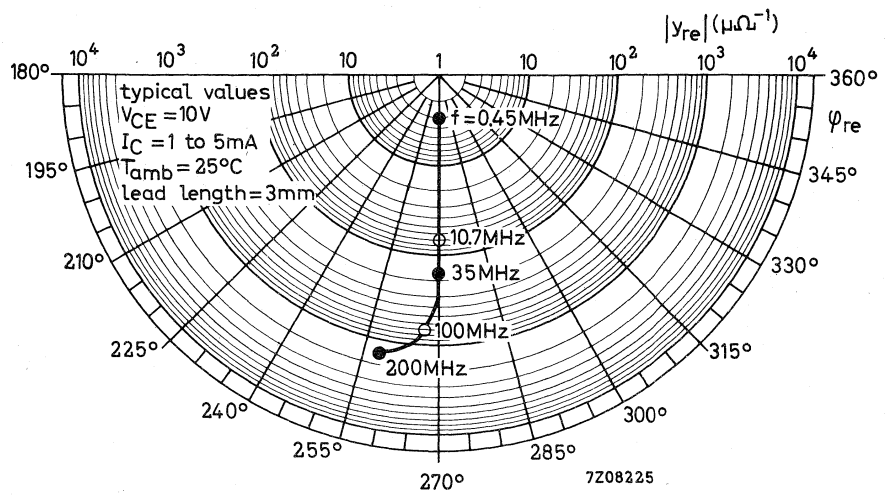

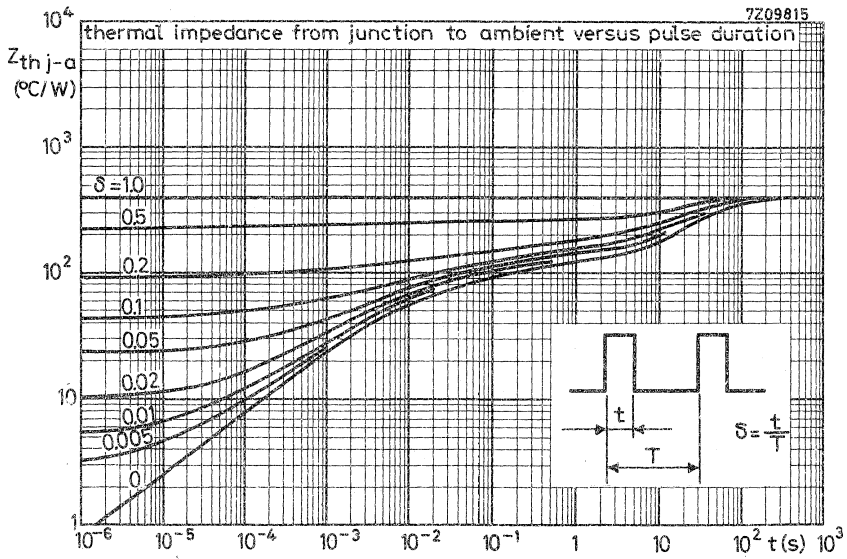
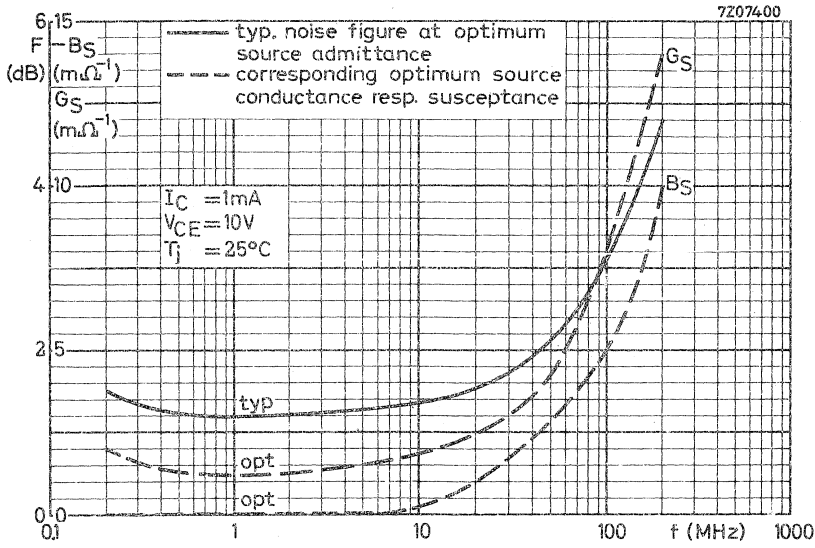

SILICON PLANAR EPITAXIAL TRANSISTOR

N-P-N transistor in a plastic envelope with stiff self-locking pins suitable for use with standard printed boards.

The BF195 is intended for h.f. applications in radio and television receivers; it is especially recommended for f.m. tuners, i.f. amplifiers in a.m./f.m. receivers where a low transistor output conductance is of importance, a.m. input stages of carradios where a low noise figure at low source impedance is required.

| QUICK REFERENCE DATA | | |
|---|-----------|---------------------------|
| Collector-base voltage (open emitter) | V_{CBO} | max. 30 V |
| Collector-emitter voltage (open base) | V_{CEO} | max. 20 V |
| Collector current (d.c.) | I_C | max. 30 mA |
| Total power dissipation up to $T_{amb} = 25^\circ\text{C}$ | P_{tot} | max. 250 mW |
| Junction temperature | T_j | max. 125 $^\circ\text{C}$ |
| D.C. current gain at $T_j = 25^\circ\text{C}$ $I_C = 1\text{ mA}; V_{CE} = 10\text{ V}$ | h_{FE} | typ. 67 |
| Transition frequency $I_C = 1\text{ mA}; V_{CE} = 10\text{ V}$ | f_T | typ. 200 MHz |
| Noise figure $I_C = 1\text{ mA}; V_{CE} = 10\text{ V}$ $G_S = 20\text{ m}\Omega^{-1}; f = 1\text{ MHz}$ | F | typ. 3.5 dB |
| $G_S = 10\text{ m}\Omega^{-1}; f = 100\text{ MHz}$ | F | typ. 4 dB |

MECHANICAL DATA

Dimensions in mm

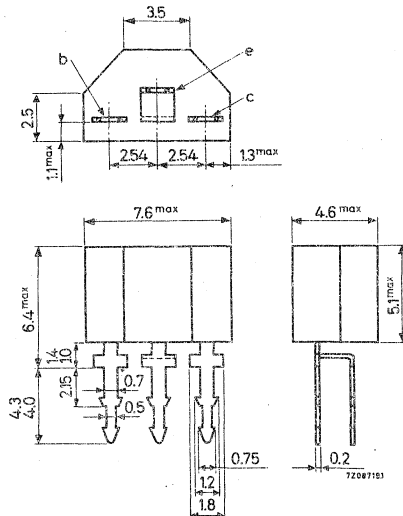

MOUNTING INSTRUCTIONS

1. Thickness of printed board: max. 1.1 mm
Hole diameter 0.77 to 0.83 mm
2. Thickness of printed board: max. 1.7 mm
Hole diameter 1.25 to 1.35 mm

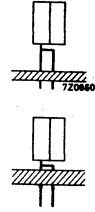

Bore plan

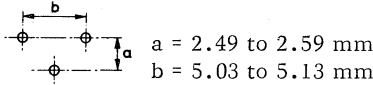

RATINGS Limiting values in accordance with the Absolute Maximum System (IEC 134)

Voltages

| | | | |
|--|-----------|------|------|
| Collector-base voltage (open emitter) | V_{CBO} | max. | 30 V |
| Collector-emitter voltage (open base) (See also page 4) | V_{CEO} | max. | 20 V |
| Emitter-base voltage (open collector) | V_{EBO} | max. | 5 V |

Currents

| | | | |
|--------------------------------|----------|------|-------|
| Collector current (d.c.) | I_C | max. | 30 mA |
| Collector current (peak value) | I_{CM} | max. | 30 mA |

Power dissipation

| | | | |
|--|-----------|------|--------|
| Total power dissipation up to $T_{amb} = 25\text{ }^\circ\text{C}$ | P_{tot} | max. | 250 mW |
|--|-----------|------|--------|

Temperatures

| | | | |
|----------------------|-----------|-------------|----------------------|
| Storage temperature | T_{stg} | -65 to +125 | $^\circ\text{C}$ |
| Junction temperature | T_j | max. | 125 $^\circ\text{C}$ |

THERMAL RESISTANCE

| | | | |
|--------------------------------------|---------------|---|--------------------------------|
| From junction to ambient in free air | $R_{th\ j-a}$ | = | 0.4 $^\circ\text{C}/\text{mW}$ |
|--------------------------------------|---------------|---|--------------------------------|

CHARACTERISTICS

$T_j = 25^\circ\text{C}$

Base-emitter voltage ¹⁾

$I_C = 1\text{ mA}; V_{CE} = 10\text{ V}$

V_{BE} 0.65 to 0.74 V

Base current

$I_C = 1\text{ mA}; V_{CE} = 10\text{ V}$

I_B 8 to 28 μA
typ. 15 μA

Feedback capacitance at $f = 0.45\text{ MHz}$

$I_C = 1\text{ mA}; V_{CE} = 10\text{ V}$

C_{re} typ. 0.95 pF

Transition frequency

$I_C = 1\text{ mA}; V_{CE} = 10\text{ V}$

f_T typ. 200 MHz

Noise figure

$I_C = 1\text{ mA}; V_{CE} = 10\text{ V}$

$G_S = 20\text{ m}\Omega^{-1}; f = 1\text{ MHz}$

F typ. 3.5 dB

$G_S = 10\text{ m}\Omega^{-1}; f = 100\text{ MHz}$

F typ. 4 dB

Conversion noise figure

$I_C = 1\text{ mA}; V_{CE} = 10\text{ V}$

$G_S = 1.2\text{ m}\Omega^{-1}; f = 0.2\text{ MHz}$

F_c typ. 4 dB

$G_S = 1.5\text{ m}\Omega^{-1}; f = 1\text{ MHz}$

F_c typ. 2.5 dB

y parameters at $f = 100\text{ MHz}$ (common base)

$I_C = 1\text{ mA}; V_{CE} = 10\text{ V}$ (lead length = 3 mm)

Input conductance

g_{ib} typ. 38 $\text{m}\Omega^{-1}$

Input susceptance

$-b_{ib}$ typ. 1 $\text{m}\Omega^{-1}$

Feedback admittance

$|Y_{rb}|$ typ. 440 $\mu\Omega^{-1}$

Phase angle of feedback admittance

φ_{rb} typ. 275°

Transfer admittance

$|Y_{fb}|$ typ. 34 $\text{m}\Omega^{-1}$

Phase angle of transfer admittance

φ_{fb} typ. 140°

Output conductance

g_{ob} typ. 12 $\mu\Omega^{-1}$

Output susceptance

b_{ob} typ. 1.1 $\text{m}\Omega^{-1}$

y parameters (common emitter)

$I_C = 1\text{ mA}; V_{CE} = 10\text{ V}$ (lead length = 3 mm) $f = 10.7\text{ MHz}$ | $f = 0.45\text{ MHz}$

Input conductance

$g_{ie} < 0.96$ | 0.86 $\text{m}\Omega^{-1}$

Output conductance

$g_{oe} < 9.5$ | 7.0 $\mu\Omega^{-1}$

1) V_{BE} decreases by about 1.7 mV/°C with increasing temperature.

7Z082281

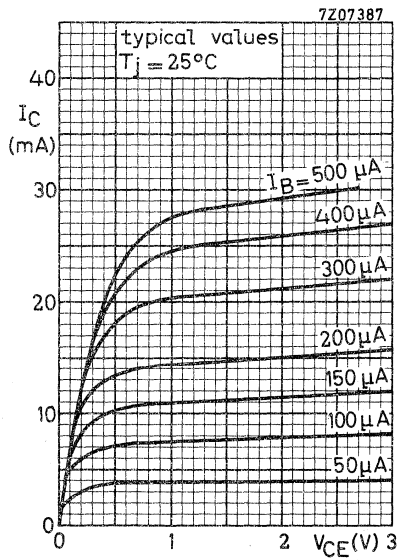
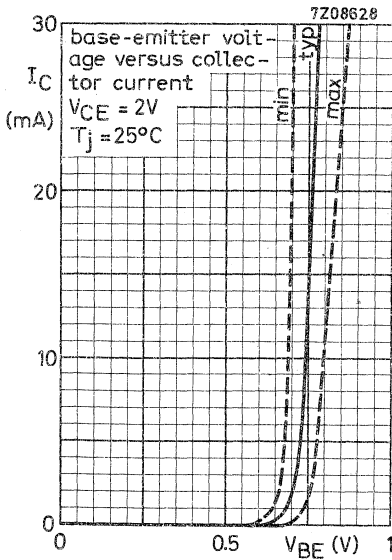
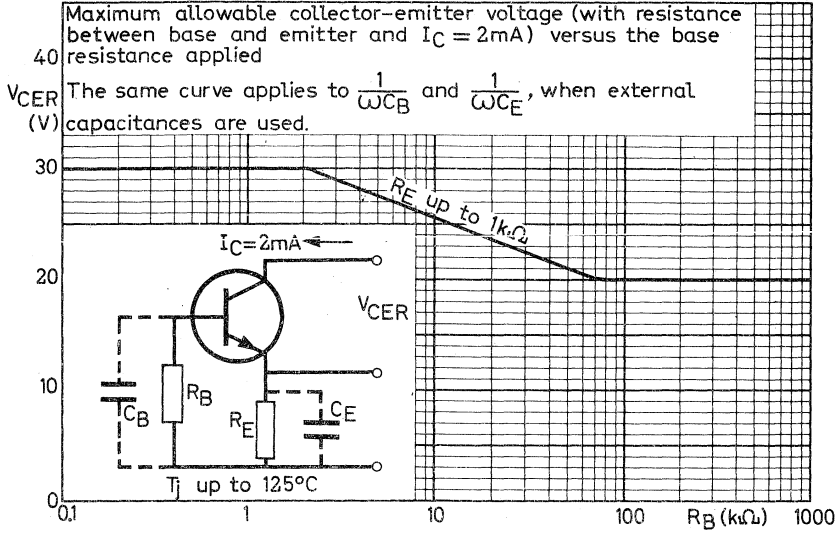

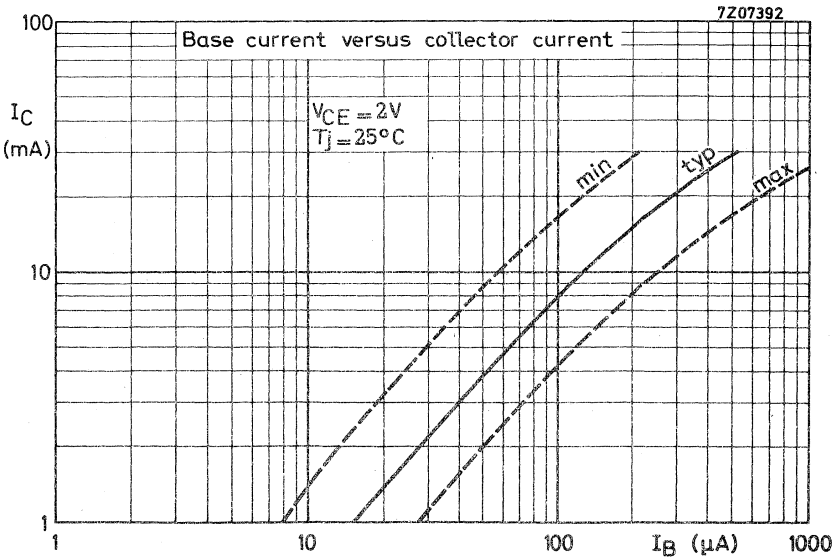
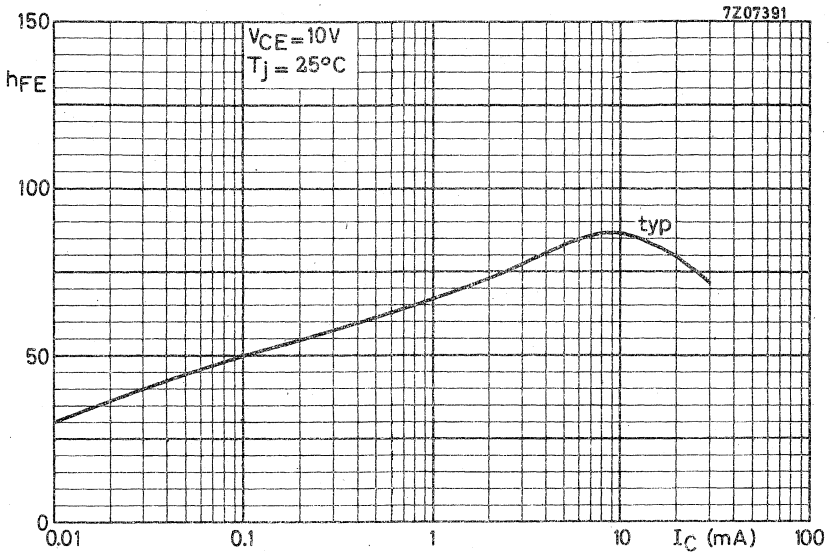

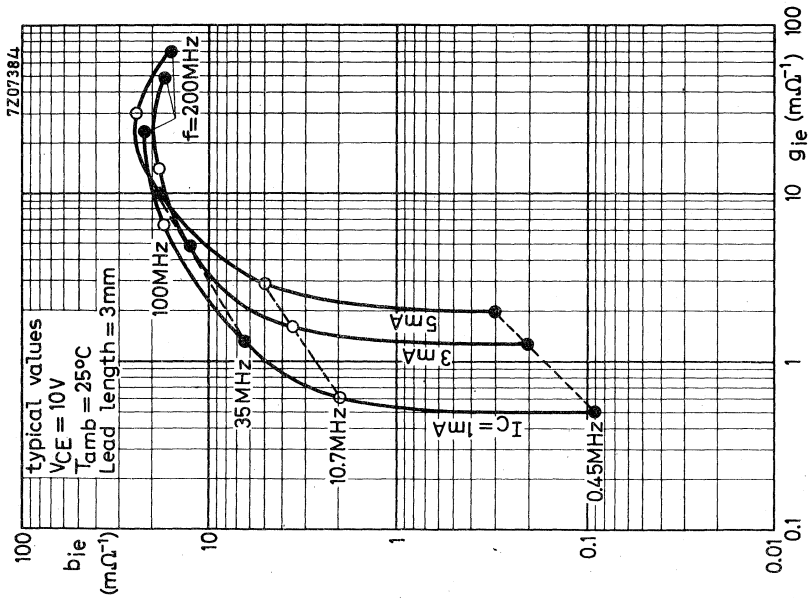
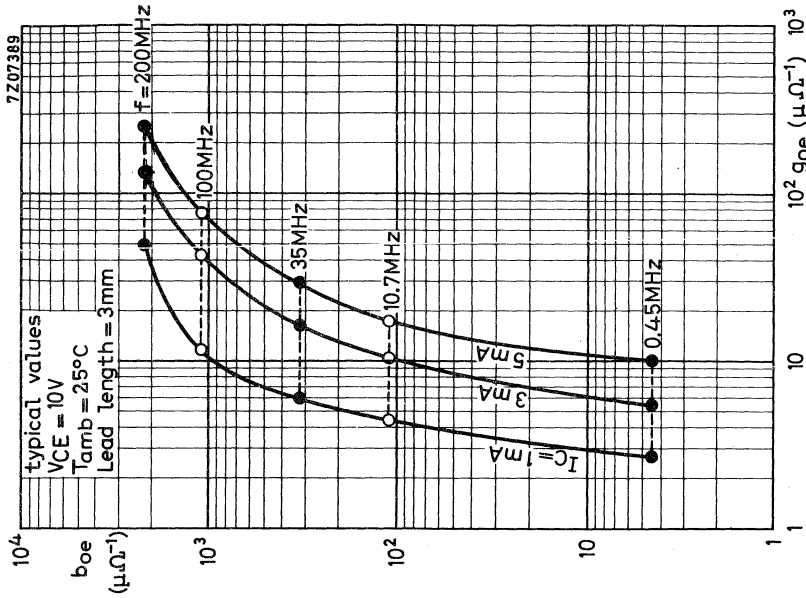

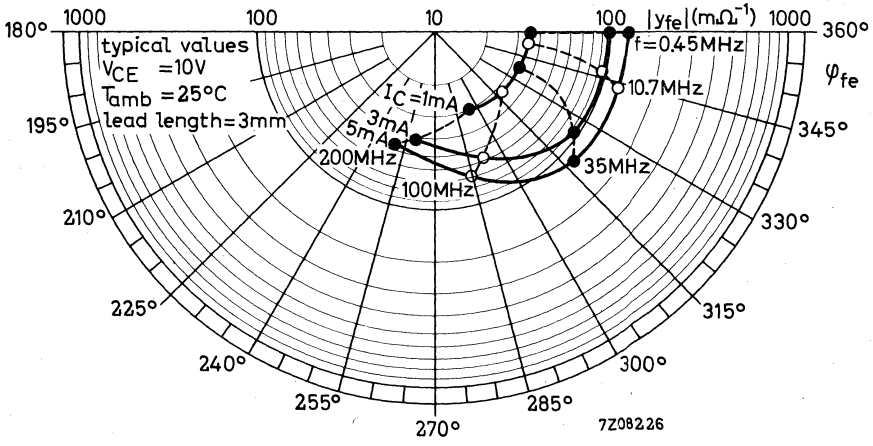
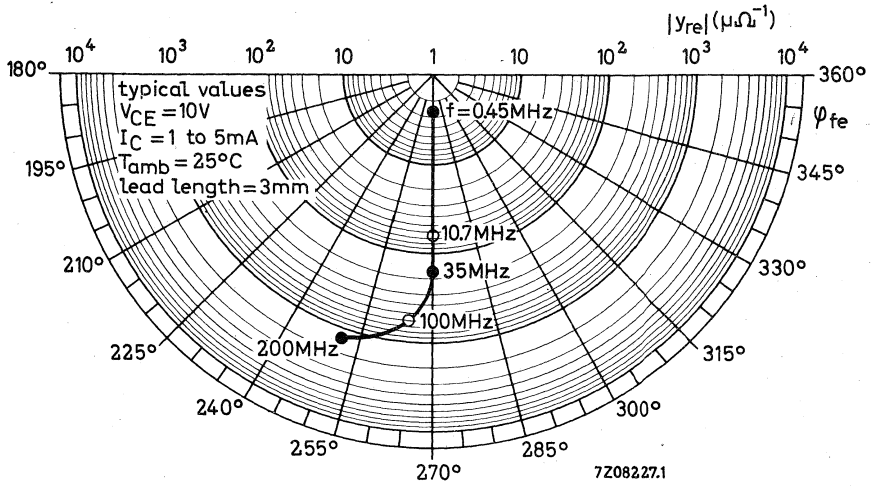
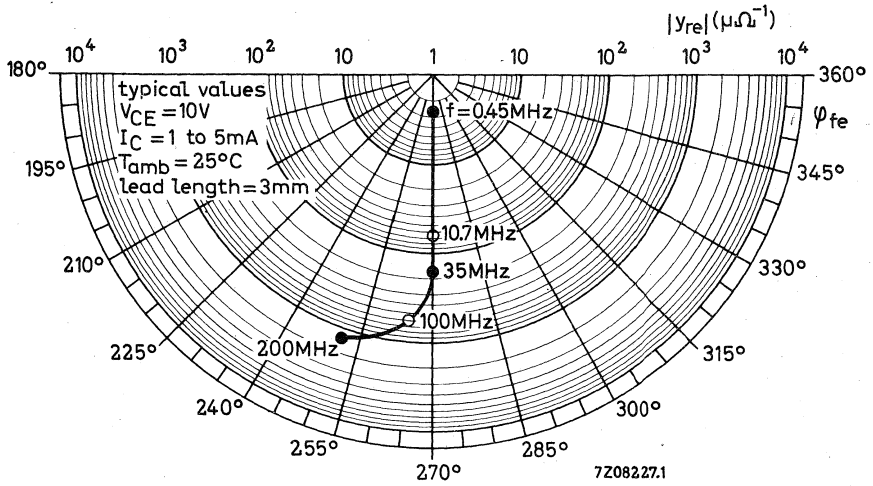
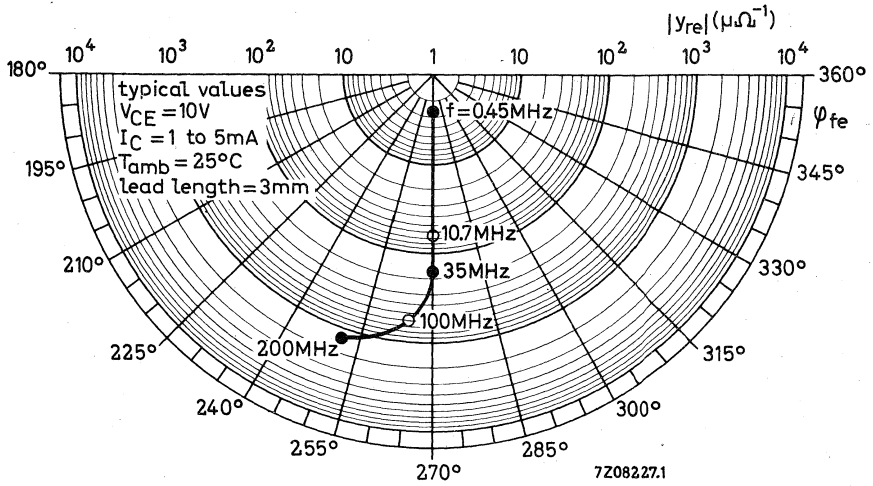

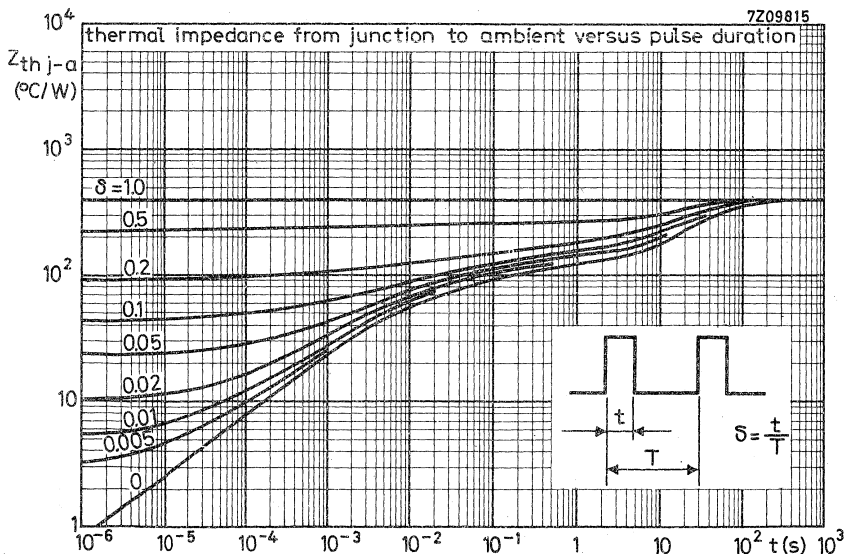
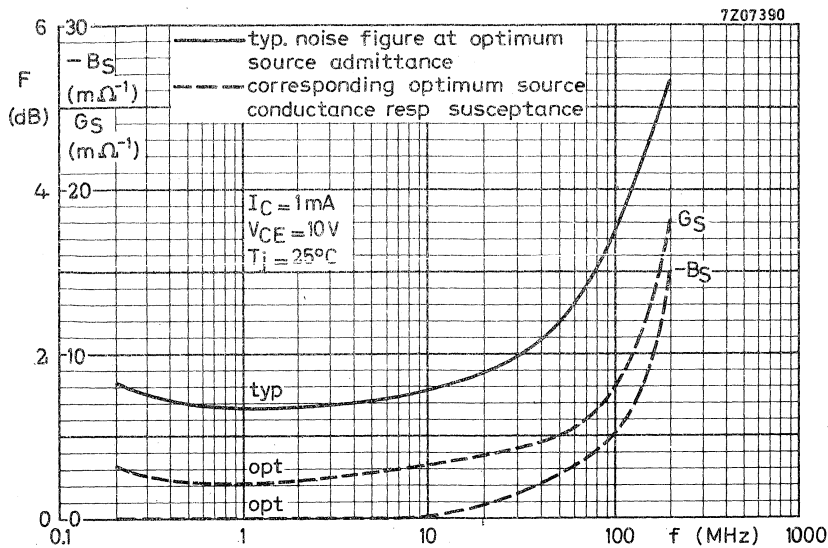

SILICON PLANAR TRANSISTOR

N-P-N transistor in a plastic envelope with stiff self-locking pins suitable for use with standard printed-circuit boards. The transistor has a very low feedback capacitance and is intended for use in the forward gain control stage of the television i. f. amplifier.

QUICK REFERENCE DATA

| | | | |
|---|-----------------|------|----------------------|
| Collector-base voltage (open emitter) | V_{CBO} | max. | 40 V |
| Collector-emitter voltage (open base) | V_{CEO} | max. | 30 V |
| Collector current (d. c.) | I_C | max. | 25 mA |
| Total power dissipation up to $T_{amb} = 25\text{ }^\circ\text{C}$ | P_{tot} | max. | 250 mW |
| Junction temperature | T_j | max. | 125 $^\circ\text{C}$ |
| Transition frequency $I_C = 4\text{ mA}; V_{CE} = 10\text{ V}$ | f_T | typ. | 400 MHz |
| Feedback capacitance at $f = 10, 7\text{ MHz}$ $I_C = 1\text{ mA}; V_{CE} = 10\text{ V}$ | C_{re} | typ. | 200 fF |
| Max. unilateralized power gain $I_C = 4\text{ mA}; V_{CE} = 10\text{ V}; f = 35\text{ MHz}$ $f = 45\text{ MHz}$ | G_{UM} | typ. | 42 dB |
| | G_{UM} | typ. | 39 dB |
| Gain control range | ΔG_{tr} | typ. | 60 dB |

MECHANICAL DATA

SOT-25

Dimensions in mm

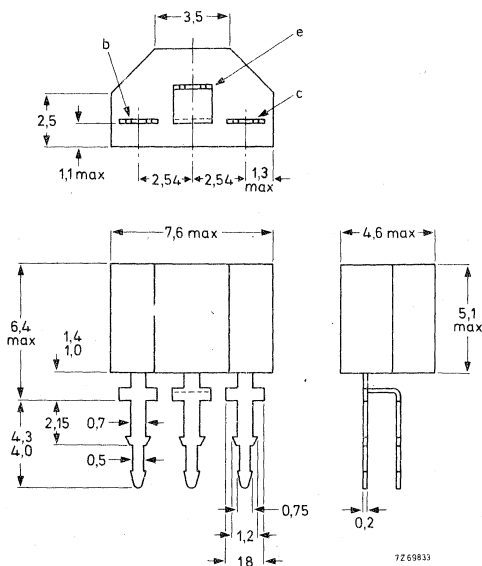

MOUNTING INSTRUCTIONS

1. Thickness of printed board: max. 1.1 mm
Hole diameter 0.77 to 0.83 mm
2. Thickness of printed board: max. 1.7 mm
Hole diameter 1.25 to 1.35 mm

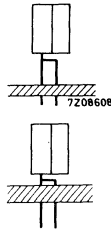

Bore plan

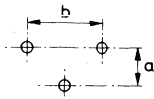

$a = 2.49$ to 2.59 mm

$b = 5.03$ to 5.13 mm

RATINGS (Limiting values) ¹⁾

Voltages

| | | | |
|---------------------------------------|-----------|------|--------------------|
| Collector-base voltage (open emitter) | V_{CBO} | max. | 40 V |
| Collector-emitter voltage (open base) | V_{CEO} | max. | 30 V ²⁾ |
| Emitter-base voltage (open collector) | V_{EBO} | max. | 4 V |

Currents

| | | | |
|--------------------------------|----------|------|-------|
| Collector current (d.c.) | I_C | max. | 25 mA |
| Collector current (peak value) | I_{CM} | max. | 25 mA |

Power dissipation

| | | | |
|---|-----------|------|--------|
| Total power dissipation up to $T_{amb} = 25$ °C | P_{tot} | max. | 250 mW |
|---|-----------|------|--------|

Temperatures

| | | |
|----------------------|-----------|----------------|
| Storage temperature | T_{stg} | -65 to +125 °C |
| Junction temperature | T_j | max. 125 °C |

THERMAL RESISTANCE

| | | | |
|--------------------------------------|---------------|---|-----------|
| From junction to ambient in free air | $R_{th\ j-a}$ | = | 0.4 °C/mW |
|--------------------------------------|---------------|---|-----------|

¹⁾ Limiting values according to the Absolute Maximum System as defined in IEC publication 134.

²⁾ See also page 6.

CHARACTERISTICS

$T_{amb} = 25\text{ }^{\circ}\text{C}$ unless otherwise specified

Base current at about 50 dB gain control

$I_C = 6\text{ mA}; V_{CE} = 2\text{ V}$

$I_B < 270\text{ }\mu\text{A}$

$I_C = 15\text{ mA}; V_{CE} = 5\text{ V}$

$I_B < 1.5\text{ mA}$

Base current

$I_C = 4\text{ mA}; V_{CE} = 10\text{ V}$

I_B typ. $60\text{ }\mu\text{A}$
 $< 150\text{ }\mu\text{A}$

Base-emitter voltage ¹⁾

$I_C = 4\text{ mA}; V_{CE} = 10\text{ V}$

V_{BE} typ. 750 mV
 $< 840\text{ mV}$

Feedback capacitance at $f = 10.7\text{ MHz}$

$I_C = 1\text{ mA}; V_{CE} = 10\text{ V}$

C_{re} typ. 200 fF

Transition frequency at $f = 100\text{ MHz}$

$I_C = 4\text{ mA}; V_{CE} = 10\text{ V}$

f_T typ. 400 MHz

Noise figure

$I_C = 4\text{ mA}; V_{CE} = 10\text{ V}$
 $G_S = 10\text{ m}\Omega^{-1}; f = 35\text{ MHz}; B_S = 0$

F typ. 3 dB

y parameters (common emitter)

$I_C = 4\text{ mA}; V_{CE} = 10\text{ V}$ (mounted according to instruction 2, see page 2)

| | | $f = 35$ | 45 MHz |
|------------------------------------|----------------|--------------------|----------------------------|
| Input conductance | g_{ie} | typ. 3.2 | $4.8\text{ m}\Omega^{-1}$ |
| Input capacitance | C_{ie} | typ. 37 | 35 pF |
| Feedback admittance | $ y_{re} $ | typ. 47 | $60\text{ }\mu\Omega^{-1}$ |
| Phase angle of feedback admittance | φ_{re} | typ. 268° | 268° |
| Transfer admittance | $ y_{fe} $ | typ. 105 | $100\text{ m}\Omega^{-1}$ |
| Phase angle of transfer admittance | φ_{fe} | typ. 340° | 340° |
| Output conductance | g_{oe} | typ. 50 | $60\text{ }\mu\Omega^{-1}$ |
| Output capacitance | C_{oe} | typ. 1.3 | 1.3 pF |

Maximum unilateralised power gain

$G_{UM} (\text{in dB}) = 10 \log \frac{|y_{fe}|^2}{4g_{ie}g_{oe}}$

$I_C = 4\text{ mA}; V_{CE} = 10\text{ V}$

G_{UM} typ. 42 39 dB

¹⁾ V_{BE} decreases by about $1.7\text{ mV}/^{\circ}\text{C}$ with increasing temperature.

Equivalent gain control transistor

To ensure an almost constant input admittance and an output conductance that varies little with gain control, we recommend that where a BF196 is used in a gain controlled i.f. stage, a series base capacitor of 22 pF and a bias resistor of 1 kΩ be used.

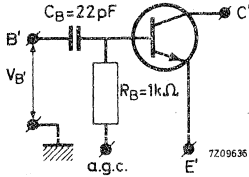

The transistor with these additional components is effectively an "equivalent transistor" for gain control purposes, the signal handling capability of which may be expressed in terms of voltage. (Without these components the varying input admittance means that the signal handling capability can only be expressed in terms of power).

The signal handling capability of the equivalent transistor as a function of ΔG_{tr} (the reduction in transducer gain with gain control) will be found on pages 4 and 5.

- a. Voltage versus ΔG_{tr} curves for a γ distortion of 5% are below.
- b. Voltage versus ΔG_{tr} curves for an in-band cross modulation factor of 1% are on page 5.

Graphs of the γ -parameters are on pages 8 to 11.

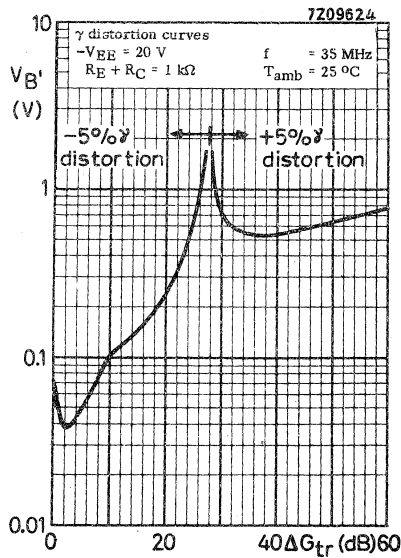
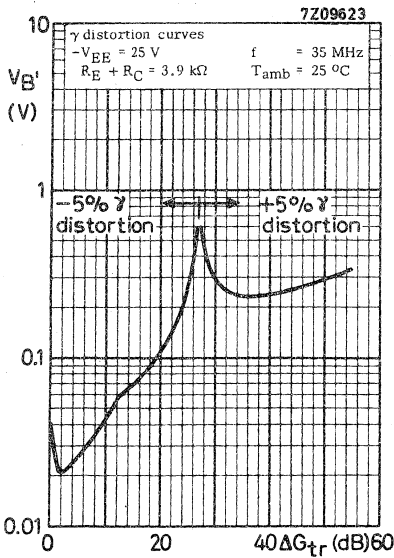

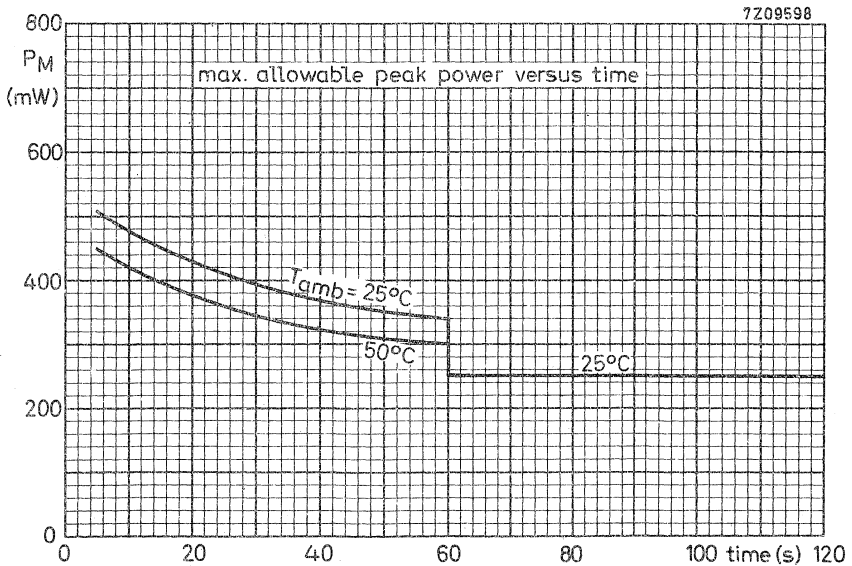
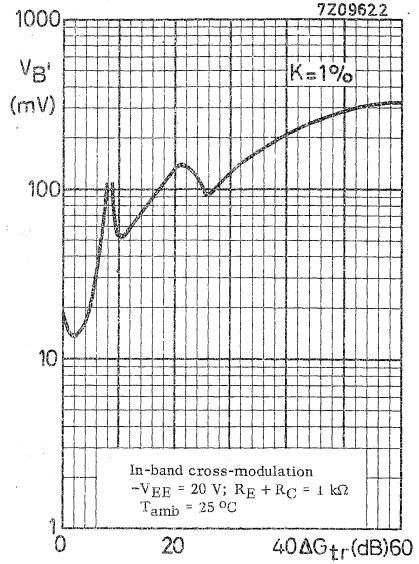
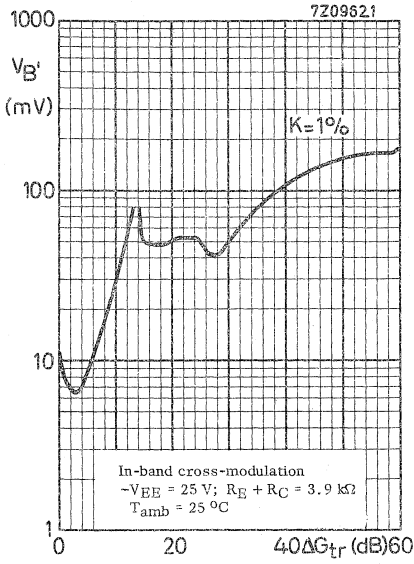

7Z09625

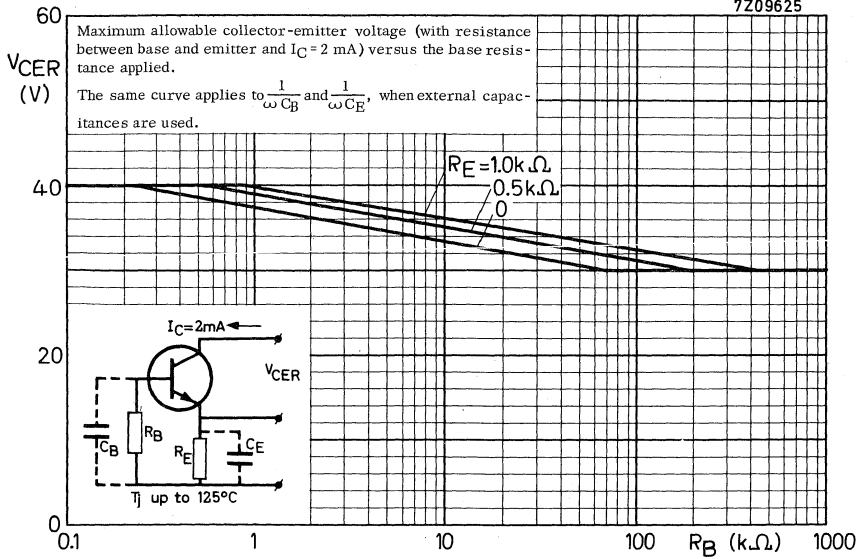

7Z09619

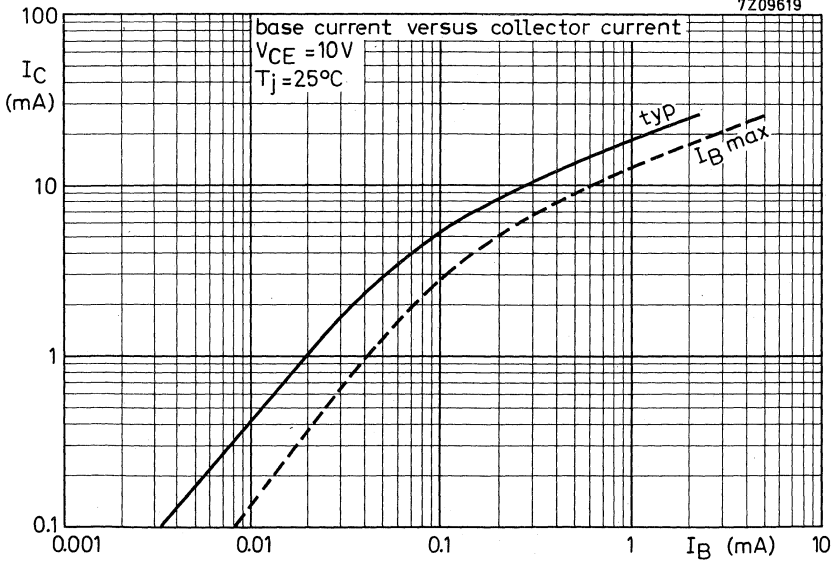

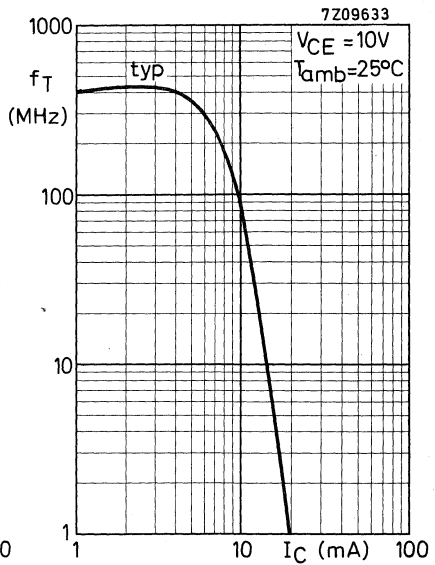
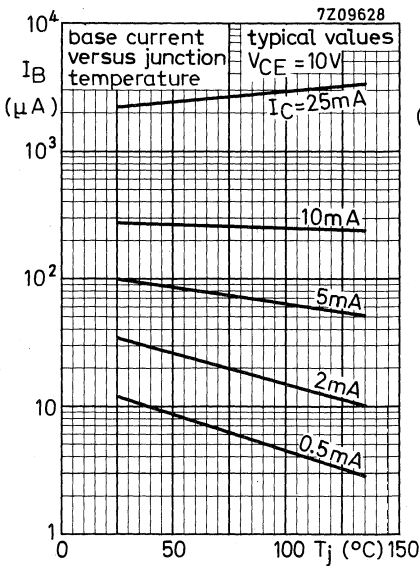
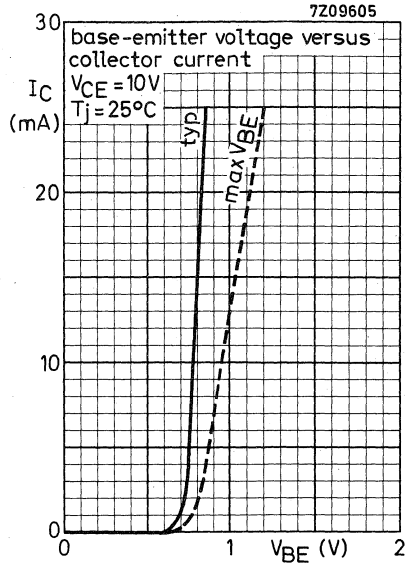
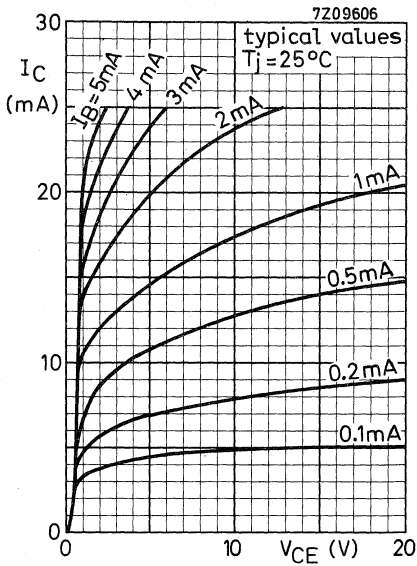

Voltage control; $-V_{EE} = 25 \text{ V}$; $R_E + R_C = 3.9 \text{ k}\Omega$; $f = 35 \text{ MHz}$

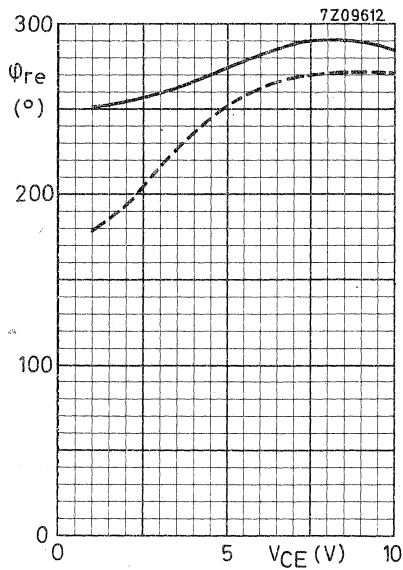
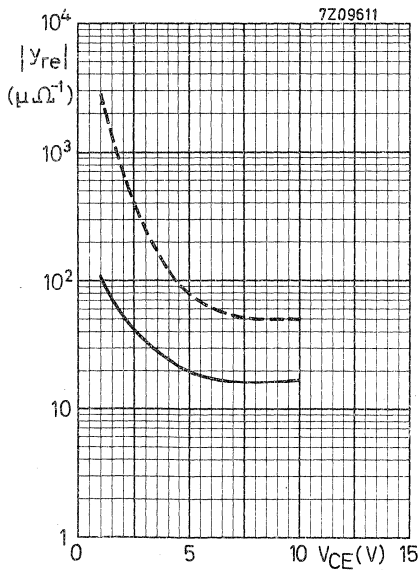
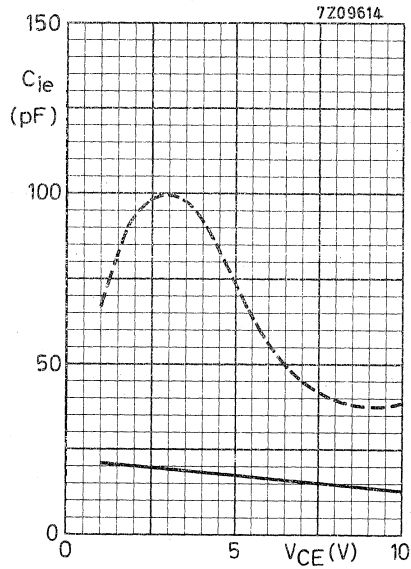
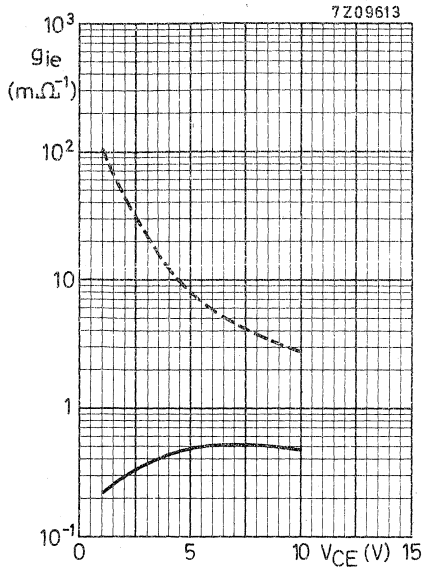

y -parameters of the equivalent gain control transistor, including base capacitor and base resistor as shown on page 4 (dashed curves apply to the transistor only).

Voltage control; $-V_{EE} = 25 \text{ V}$; $R_E + R_C = 3.9 \text{ k}\Omega$; $f = 35 \text{ MHz}$

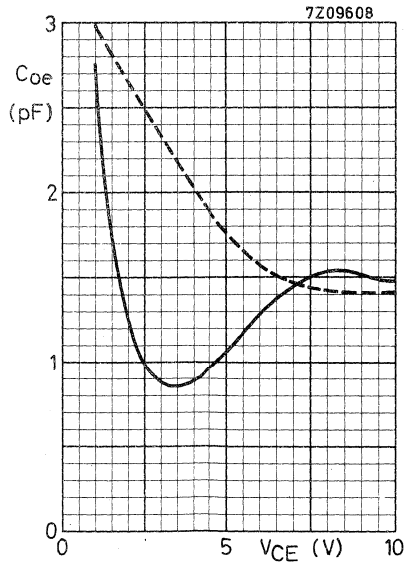
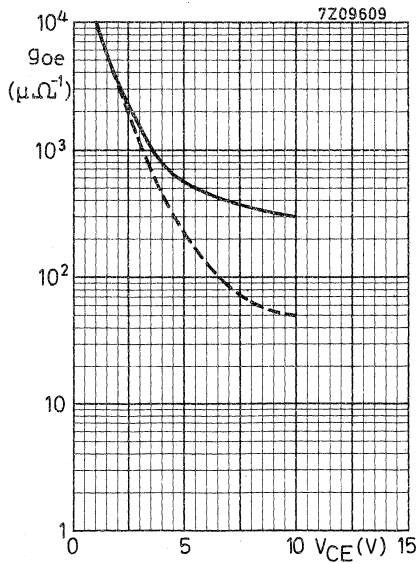
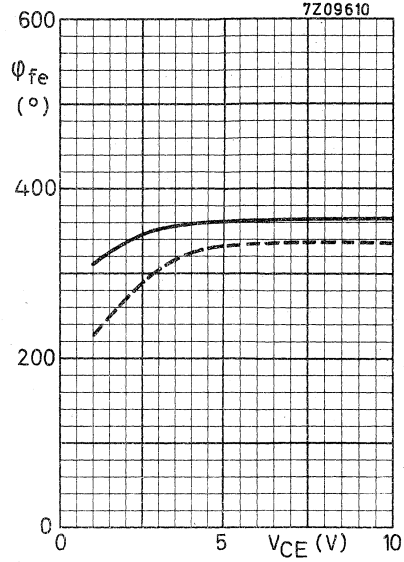
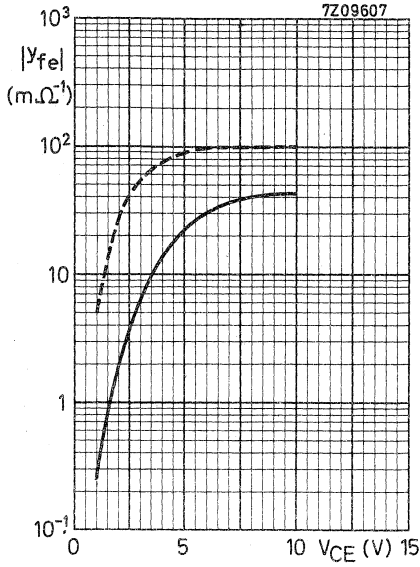

y-parameters of the equivalent gain control transistor, including base capacitor and base resistor as shown on page 4 (dashed curves apply to the transistor only).

Current control; $-V_{EE} = 20\text{ V}$; $R_E + R_C = 1\text{ k}\Omega$; $f = 35\text{ MHz}$

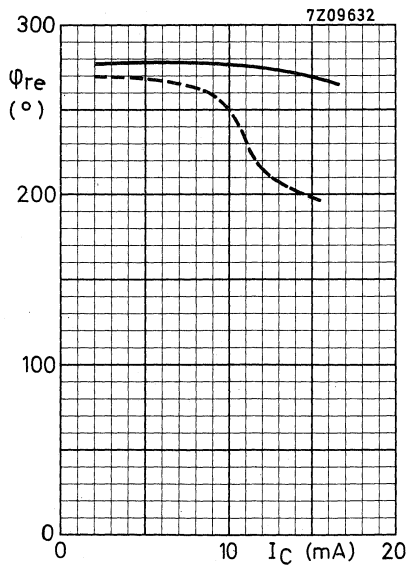
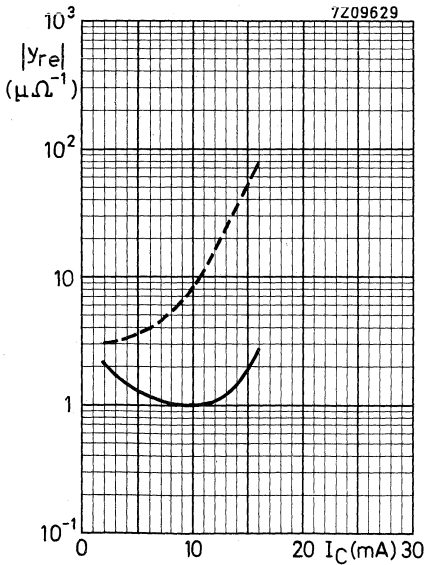
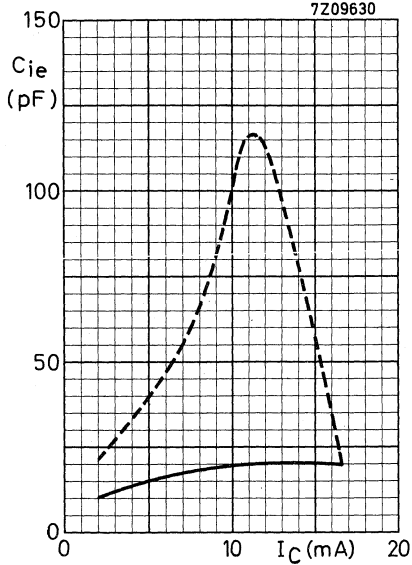
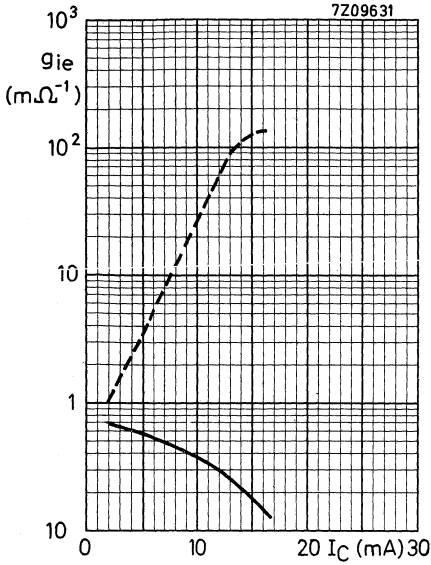

y-parameters of the equivalent gain control transistor, including base capacitor and base resistor as shown on page 4 (dashed curves apply to the transistor only).

Current control; $-V_{EE} = 20$ V; $R_E + R_C = 1$ k Ω ; $f = 35$ MHz

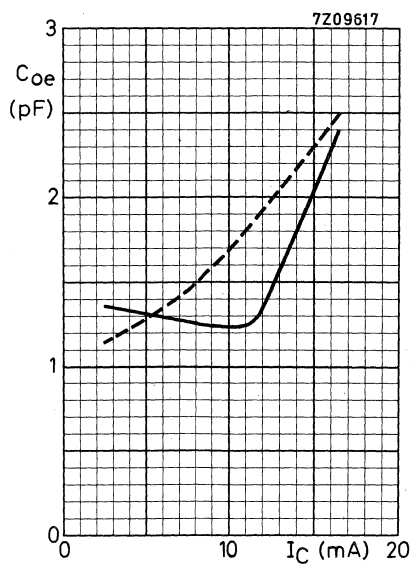
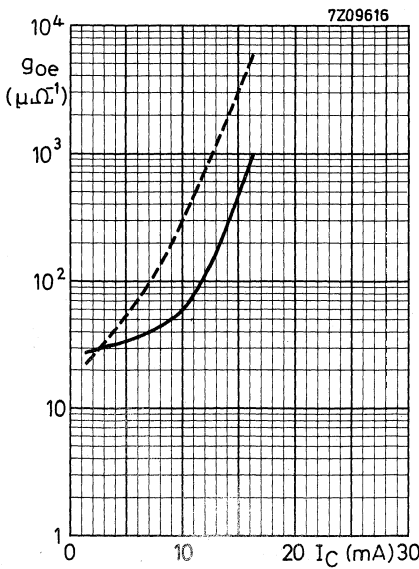
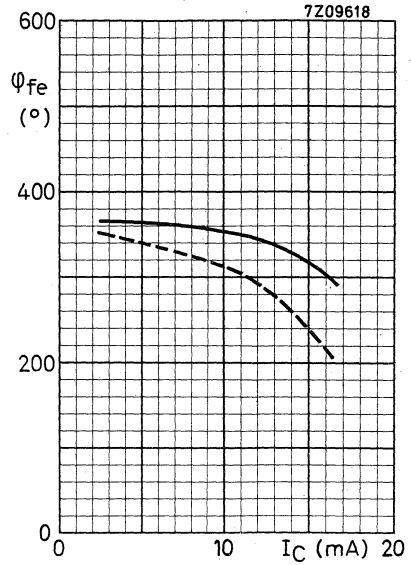
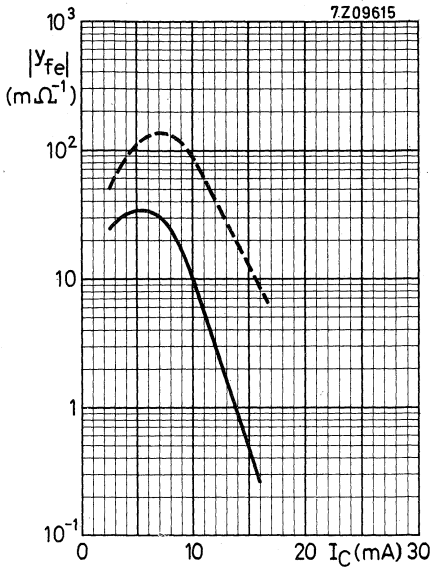

y-parameters of the equivalent gain control transistor, including base capacitor and base resistor as shown on page 4 (dashed curves apply to the transistor only).

APPLICATION INFORMATION

For application information see BF198.

.....

SILICON PLANAR EPITAXIAL TRANSISTOR

N-P-N transistor in a plastic envelope with stiff self-locking pins suitable for use with standard printed-circuit boards.

The BF197 has a very low feedback capacitance and is intended for use in the output stage of a vision i.f. amplifier.

QUICK REFERENCE DATA

| | | | |
|---|-----------|------|----------------------|
| Collector-base voltage (open emitter) | V_{CBO} | max. | 40 V |
| Collector-emitter voltage (open base) | V_{CEO} | max. | 25 V |
| Collector current (d. c.) | I_C | max. | 25 mA |
| Total power dissipation up to $T_{amb} = 25\text{ }^\circ\text{C}$ | P_{tot} | max. | 250 mW |
| Junction temperature | T_j | max. | 125 $^\circ\text{C}$ |
| Transition frequency $I_C = 5\text{ mA}; V_{CE} = 10\text{ V}$ | f_T | typ. | 550 MHz |
| Feedback capacitance at $f = 10,7\text{ MHz}$ $I_C = 1\text{ mA}; V_{CE} = 10\text{ V}$ | C_{re} | typ. | 300 fF |
| Max. unilateralized power gain $I_C = 7\text{ mA}; V_{CE} = 10\text{ V}; f = 35\text{ MHz}$ $f = 45\text{ MHz}$ | G_{UM} | typ. | 43 dB |
| | G_{UM} | typ. | 41 dB |
| Video detector output voltage | V_O | typ. | 7,7 V |

MECHANICAL DATA

SOT-25

Dimensions in mm

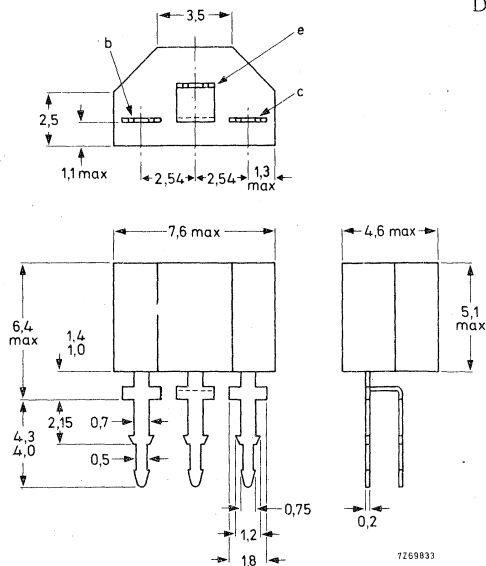

MOUNTING INSTRUCTIONS

1. Thickness of printed board: max. 1.1 mm
Hole diameter 0.77 to 0.83 mm
2. Thickness of printed board: max. 1.7 mm
Hole diameter 1.25 to 1.35 mm

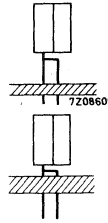

Bore plan

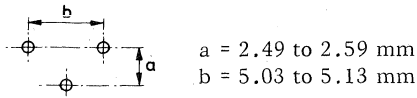

RATINGS (Limiting values) 1)

Voltages

| | | | |
|---------------------------------------|-----------|------|---------|
| Collector-base voltage (open emitter) | V_{CBO} | max. | 40 V |
| Collector-emitter voltage (open base) | V_{CEO} | max. | 25 V 2) |
| Emitter-base voltage (open collector) | V_{EBO} | max. | 4 V |

Currents

| | | | |
|--------------------------------|----------|------|-------|
| Collector current (d.c.) | I_C | max. | 25 mA |
| Collector current (peak value) | I_{CM} | max. | 25 mA |

Power dissipation

| | | | |
|---|-----------|------|--------|
| Total power dissipation up to $T_{amb} = 25 \text{ }^\circ\text{C}$ | P_{tot} | max. | 250 mW |
|---|-----------|------|--------|

Temperatures

| | | | |
|----------------------|-----------|-------------|----------------------|
| Storage temperature | T_{stg} | -65 to +125 | $^\circ\text{C}$ |
| Junction temperature | T_j | max. | 125 $^\circ\text{C}$ |

THERMAL RESISTANCE

| | | | |
|--------------------------------------|----------------|---|--------------------------------|
| From junction to ambient in free air | $R_{th \ j-a}$ | = | 0.4 $^\circ\text{C}/\text{mW}$ |
|--------------------------------------|----------------|---|--------------------------------|

1) Limiting values according to the Absolute Maximum System as defined in IEC publication 134.

2) See also page 4.

CHARACTERISTICS

$T_{amb} = 25\text{ }^{\circ}\text{C}$ unless otherwise specified

Base current

$I_C = 7\text{ mA}; V_{CE} = 10\text{ V}$ I_B typ. 60 μA
 $< 185\text{ } \mu\text{A}$

Base-emitter voltage 1)

$I_C = 7\text{ mA}; V_{CE} = 10\text{ V}$ V_{BE} typ. 750 mV
 $< 900\text{ mV}$

Feedback capacitance at $f = 10, 7\text{ MHz}$

$I_C = 1\text{ mA}; V_{CE} = 10\text{ V}$ C_{re} typ. 300 fF

Transition frequency at $f = 100\text{ MHz}$

$I_C = 5\text{ mA}; V_{CE} = 10\text{ V}$ f_T typ. 550 MHz

y parameters (common emitter)

$I_C = 7\text{ mA}; V_{CE} = 10\text{ V}$ (mounted according to instruction 2, see page 2)

| | | f = 35 45 MHz | |
|------------------------------------|----------------|--------------------|--------------------|
| Input conductance | g_{ie} | typ. 4,5 | 5,5 mA/V |
| Input capacitance | C_{ie} | typ. 45 | 45 pF |
| Feedback admittance | $ y_{re} $ | typ. 67 | 86 $\mu\text{A/V}$ |
| Phase angle of feedback admittance | φ_{re} | typ. 268° | 268° |
| Transfer admittance | $ y_{fe} $ | typ. 170 | 155 mA/V |
| Phase angle of transfer admittance | φ_{fe} | typ. 338° | 335° |
| Output conductance | g_{oe} | typ. 85 | 95 $\mu\text{A/V}$ |
| Output capacitance | C_{oe} | typ. 1,8 | 1,8 pF |

Maximum unilateralized power gain

$$G_{UM} \text{ (in dB)} = 10 \log \frac{|y_{fe}|^2}{4g_{ie}g_{oe}}$$

$I_C = 7\text{ mA}; V_{CE} = 10\text{ V}$ G_{UM} typ. 43 41 dB

1) V_{BE} decreases by about 1,7 mV/°C with increasing temperature.

7Z09598

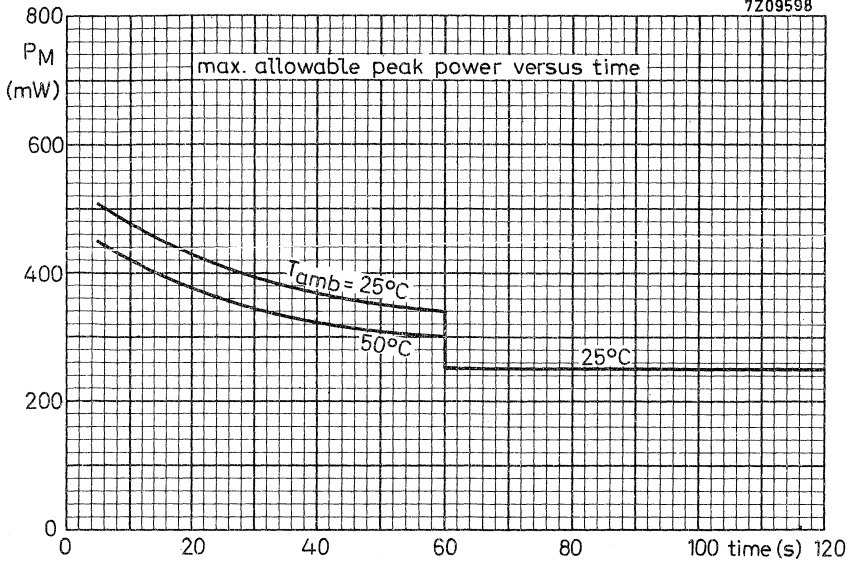

7Z09597

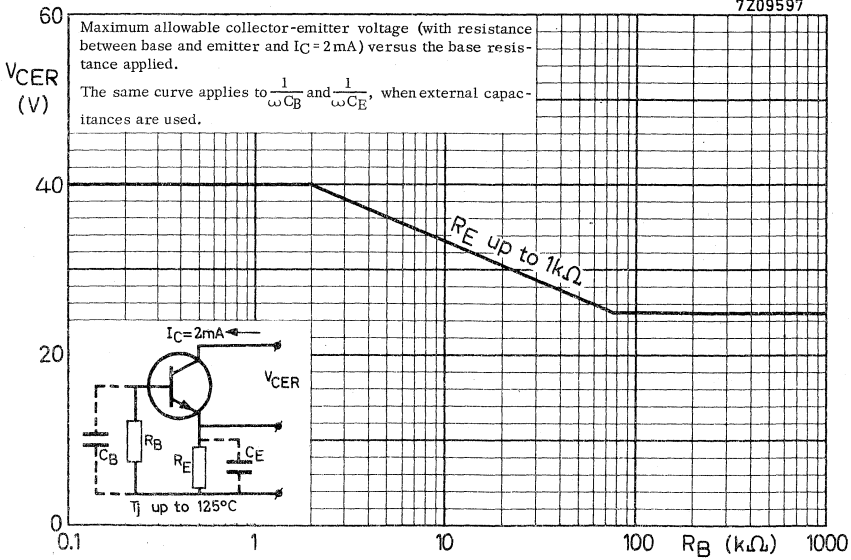

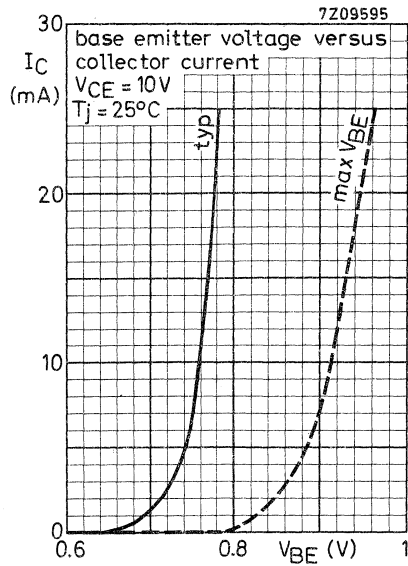
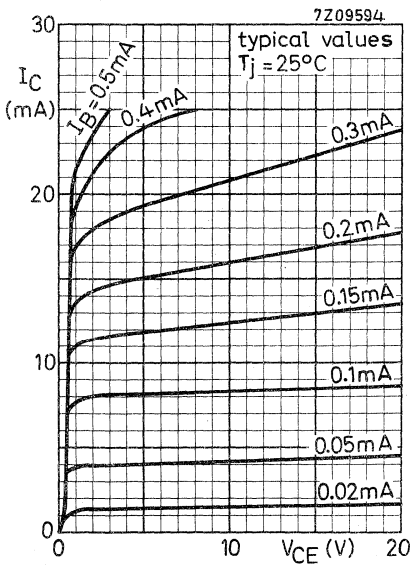
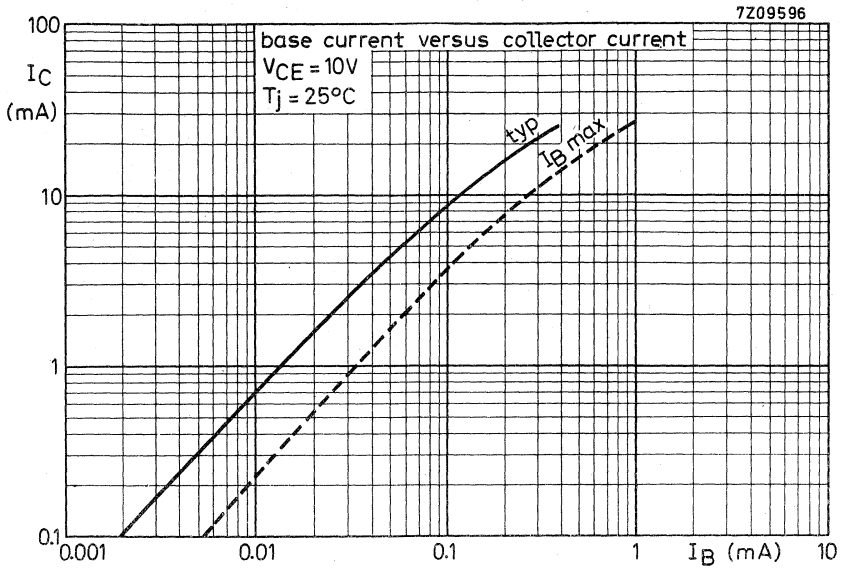

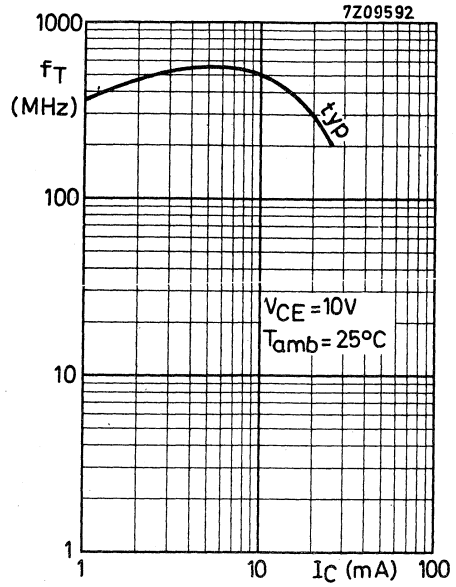
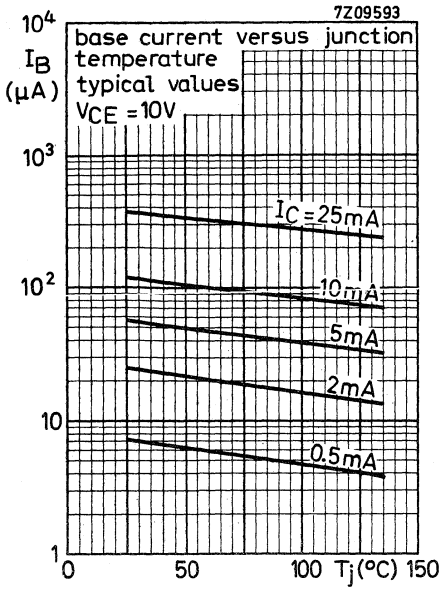

APPLICATION INFORMATION

For application information see BF199.

SILICON PLANAR TRANSISTOR

N-P-N transistor in a plastic TO-92 variant.

The BF198 has a very low feedback capacitance and is intended for use in the forward gain control stage of the television i. f. amplifier.

| QUICK REFERENCE DATA | | | |
|---|-----------------|------|----------------------|
| Collector-base voltage (open emitter) | V_{CBO} | max. | 40 V |
| Collector-emitter voltage (open base) | V_{CEO} | max. | 30 V |
| Collector current (d. c.) | I_C | max. | 25 mA |
| Total power dissipation up to $T_{amb} = 25\text{ }^\circ\text{C}$ | P_{tot} | max. | 500 mW |
| Junction temperature | T_j | max. | 150 $^\circ\text{C}$ |
| Transition frequency at $f = 100\text{ MHz}$ $I_C = 4\text{ mA}; V_{CE} = 10\text{ V}$ | f_T | typ. | 400 MHz |
| Feedback capacitance at $f = 10.7\text{ MHz}$ $I_C = 1\text{ mA}; V_{CE} = 10\text{ V}$ | C_{re} | typ. | 200 fF |
| Max. unilateralized power gain $I_C = 4\text{ mA}; V_{CE} = 10\text{ V}; f = 35\text{ MHz}$ $f = 45\text{ MHz}$ | G_{UM} | typ. | 42 dB |
| | G_{UM} | typ. | 39 dB |
| Gain control range | ΔG_{tr} | typ. | 60 dB |

MECHANICAL DATA

TO-92 variant

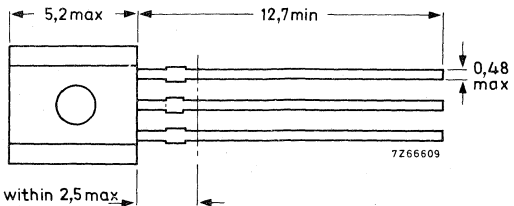
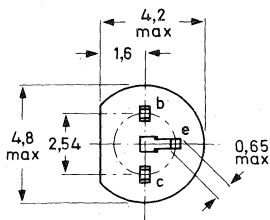
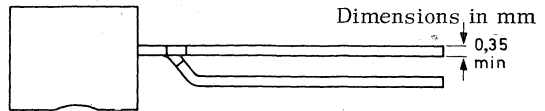

diameter within 2,5 max
is uncontrolled

RATINGS Limiting values in accordance with the Absolute Maximum System (IEC 134)

Voltages

| | | | | |
|---------------------------------------|-----------|------|----|-----------------|
| Collector-base voltage (open emitter) | V_{CBO} | max. | 40 | V |
| Collector-emitter voltage (open base) | V_{CEO} | max. | 30 | V ¹⁾ |
| Emitter-base voltage (open collector) | V_{EBO} | max. | 4 | V |

Currents

| | | | | |
|--------------------------------|----------|------|----|----|
| Collector current (d. c.) | I_C | max. | 25 | mA |
| Collector current (peak value) | I_{CM} | max. | 25 | mA |

Power dissipation

| | | | | |
|--|-----------|------|-----|----|
| Total power dissipation up to $T_{amb} = 25\text{ }^\circ\text{C}$ | P_{tot} | max. | 500 | mW |
|--|-----------|------|-----|----|

Temperatures

| | | | |
|----------------------|-----------|-------------|------------------|
| Storage temperature | T_{stg} | -65 to +150 | $^\circ\text{C}$ |
| Junction temperature | T_j | max. 150 | $^\circ\text{C}$ |

THERMAL RESISTANCE

| | | | | |
|--------------------------------------|---------------|---|------|----------------------------|
| From junction to ambient in free air | $R_{th\ j-a}$ | = | 0.25 | $^\circ\text{C}/\text{mW}$ |
|--------------------------------------|---------------|---|------|----------------------------|

¹⁾ See also page 6.

$T_{amb} = 25^{\circ}C$ unless otherwise specified

CHARACTERISTICS

Base current at about 50 dB gain control

| | | | | |
|---|-------|---|-----|---------|
| $I_C = 6 \text{ mA}; V_{CE} = 2 \text{ V}$ | I_B | < | 270 | μA |
| $I_C = 15 \text{ mA}; V_{CE} = 5 \text{ V}$ | I_B | < | 1.5 | mA |

Base current

| | | | | |
|---|-------|------|-----|---------|
| $I_C = 4 \text{ mA}; V_{CE} = 10 \text{ V}$ | I_B | typ. | 60 | μA |
| | | < | 150 | μA |

Base-emitter voltage ¹⁾

| | | | | |
|---|----------|------|-----|----|
| $I_C = 4 \text{ mA}; V_{CE} = 10 \text{ V}$ | V_{BE} | typ. | 760 | mV |
| | | < | 850 | mV |

Feedback capacitance at $f = 10.7 \text{ MHz}$

| | | | | |
|---|----------|------|-----|----|
| $I_C = 1 \text{ mA}; V_{CE} = 10 \text{ V}$ | C_{re} | typ. | 200 | fF |
|---|----------|------|-----|----|

Transition frequency at $f = 100 \text{ MHz}$

| | | | | |
|---|-------|------|-----|-----|
| $I_C = 4 \text{ mA}; V_{CE} = 10 \text{ V}$ | f_T | typ. | 400 | MHz |
|---|-------|------|-----|-----|

Noise figure

| | | | | |
|---|---|------|---|----|
| $I_C = 4 \text{ mA}; V_{CE} = 10 \text{ V}$ $G_S = 10 \text{ mA/V}; f = 35 \text{ MHz}; B_S = 0$ | F | typ. | 3 | dB |
|---|---|------|---|----|

y parameters (common emitter)

$I_C = 4 \text{ mA}; V_{CE} = 10 \text{ V}$

| | | | <u>f = 35 45 MHz</u> | |
|------------------------------------|-------------|------|------------------------|--------------|
| Input conductance | g_{ie} | typ. | 3.2 | 4.8 mA/V |
| Input capacitance | C_{ie} | typ. | 37 | 35 pF |
| Feedback admittance | $ y_{re} $ | typ. | 47 | 60 $\mu A/V$ |
| Phase angle of feedback admittance | ϕ_{re} | typ. | 268° | 268° |
| Transfer admittance | $ y_{fe} $ | typ. | 105 | 100 mA/V |
| Phase angle of transfer admittance | ϕ_{fe} | typ. | 340° | 340° |
| Output conductance | g_{oe} | typ. | 50 | 60 $\mu A/V$ |
| Output capacitance | C_{oe} | typ. | 1.3 | 1.3 pF |

Maximum unilateralized power gain

$$G_{UM} \text{ (in dB)} = 10 \log \frac{|y_{fe}|^2}{4g_{ie}g_{oe}}$$

| | | | | | |
|---|----------|------|----|----|----|
| $I_C = 4 \text{ mA}; V_{CE} = 10 \text{ V}$ | G_{UM} | typ. | 42 | 39 | dB |
|---|----------|------|----|----|----|

1) V_{BE} decreases by about 1.7 mV/°C with increasing temperature.

Equivalent gain control transistor

To ensure an almost constant input admittance and an output conductance that varies little with gain control, we recommend that where a BF198 is used in a gain controlled i. f. stage, a series base capacitor of 22 pF and a bias resistor of 1 kΩ be used.

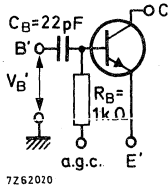

The transistor with these additional components is effectively an "equivalent transistor" for gain control purposes, the signal handling capability of which may be expressed in terms of voltage. (Without these components the varying input admittance means that the signal handling capability can only be expressed in terms of power).

The signal handling capability of the equivalent transistor as a function of ΔG_{Tr} (the reduction in transducer gain with gain control) will be found on pages 4 and 5.

- a. Voltage versus ΔG_{Tr} curves for a γ distortion of 5% are below.
- b. Voltage versus ΔG_{Tr} curves for an in-band cross modulation factor of 1% are on page 5.

Graphs of the y-parameters are on pages 8 to 11.

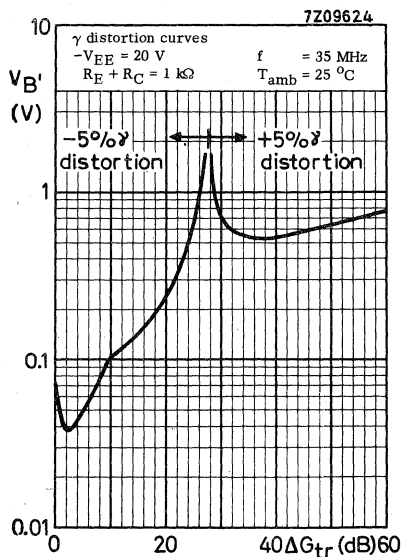
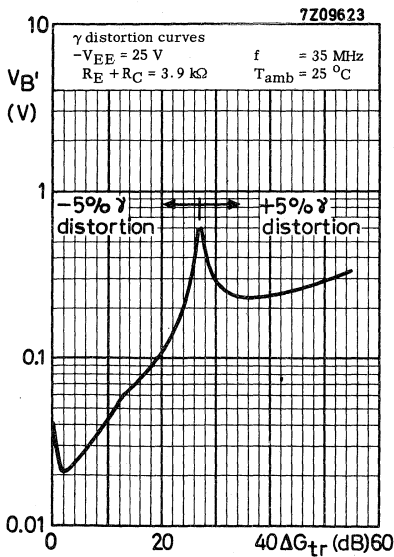

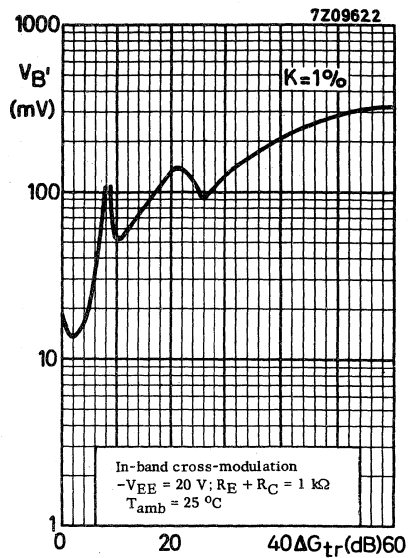
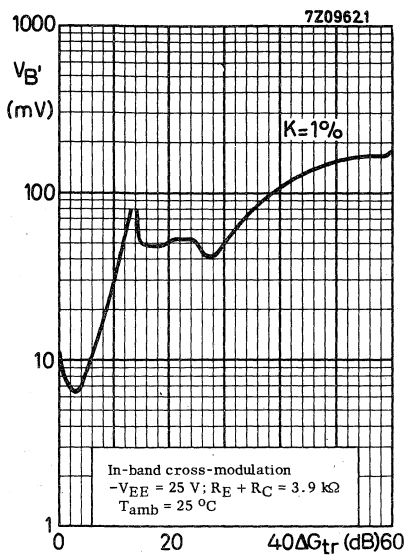

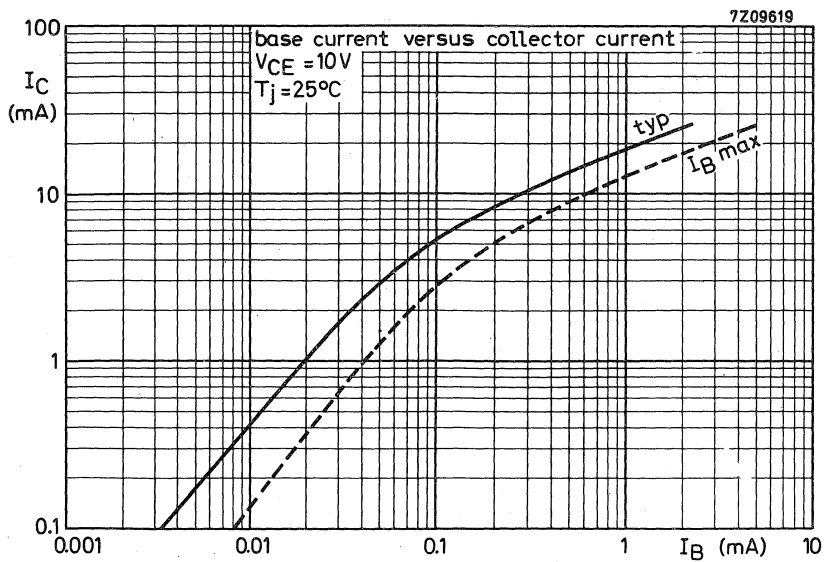
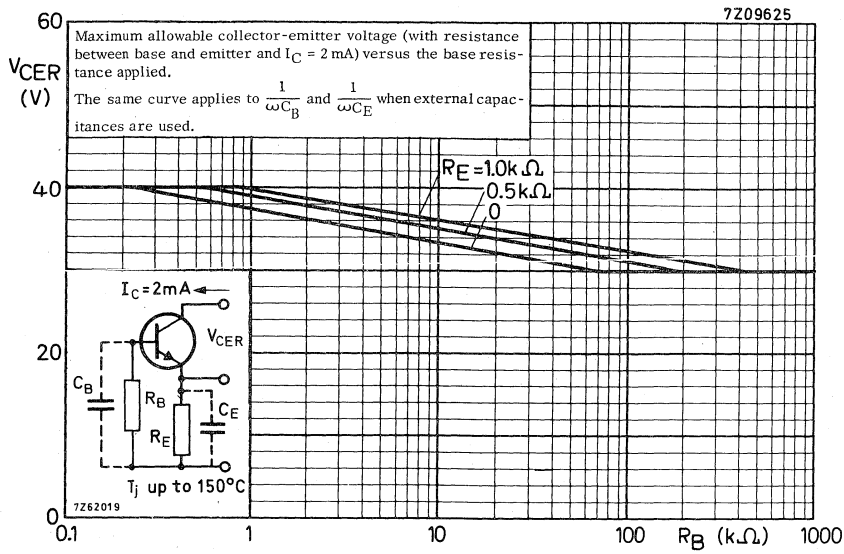

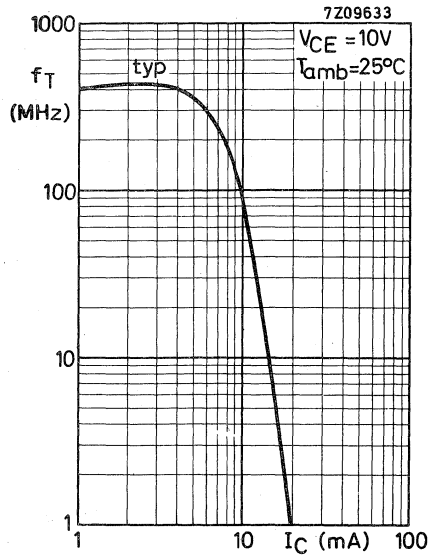
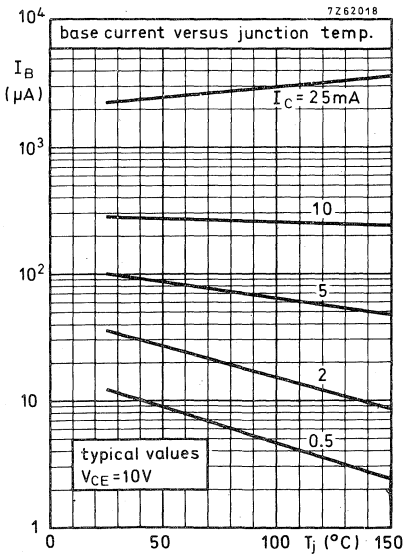
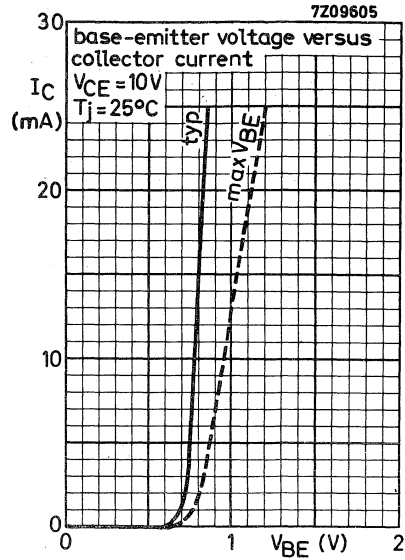
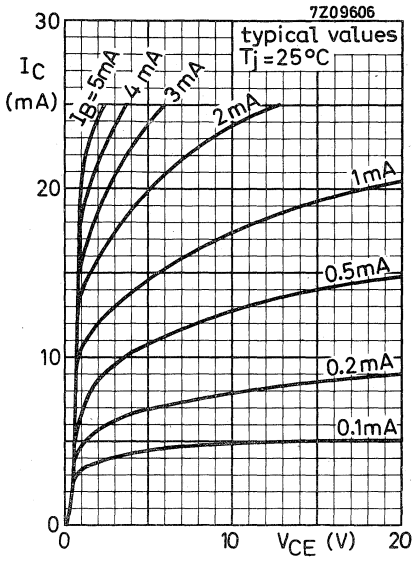

Voltage control; $-V_{EE} = 25 \text{ V}$; $R_E + R_C = 3.9 \text{ k}\Omega$; $f = 35 \text{ MHz}$

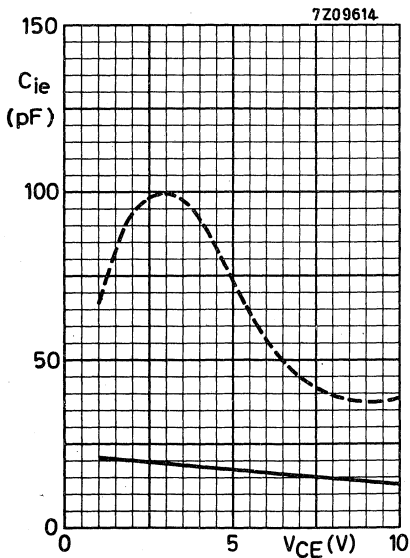
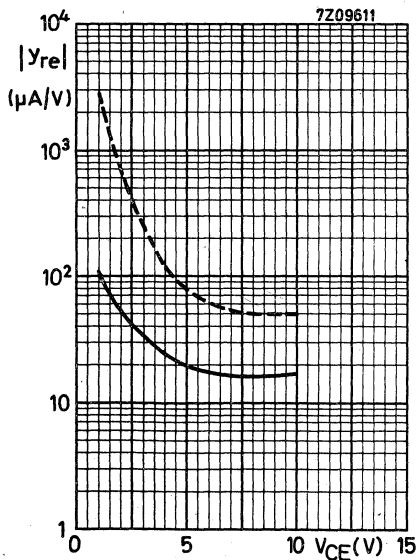
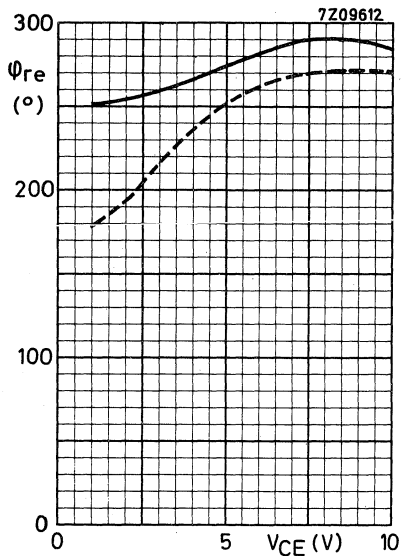
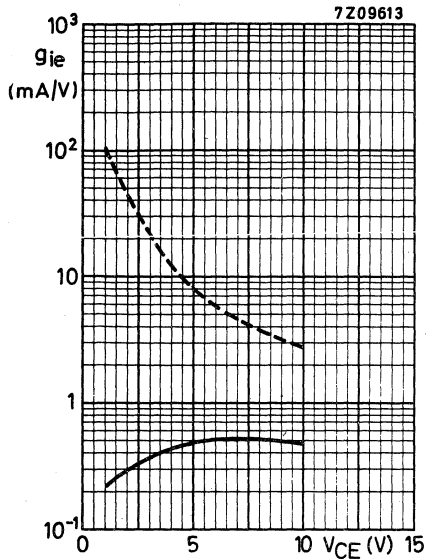

y-parameters of the equivalent gain control transistor, including base capacitor and base resistor as shown on page 4 (dashed curves apply to the transistor only).

Voltage control; $-V_{EE} = 25 \text{ V}$; $R_E + R_C = 3.9 \text{ k}\Omega$; $f = 35 \text{ MHz}$

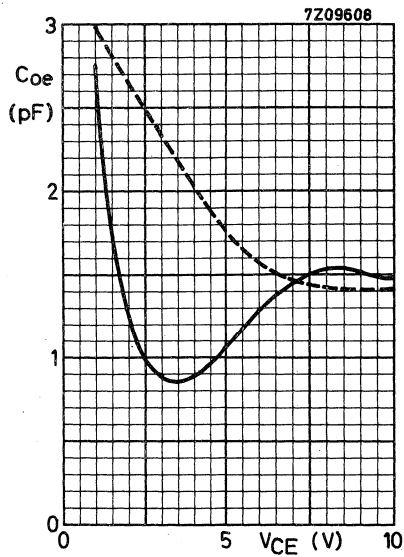
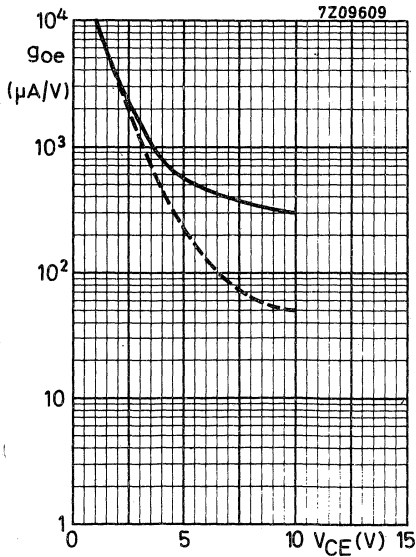
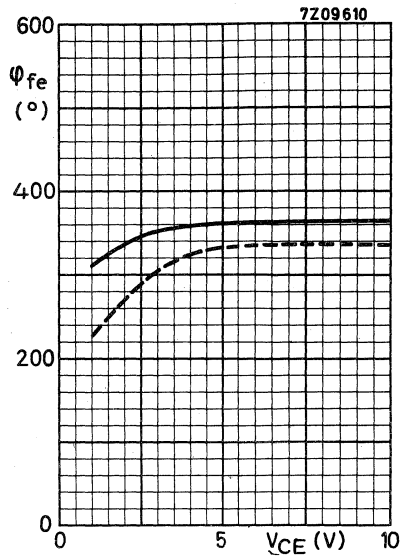
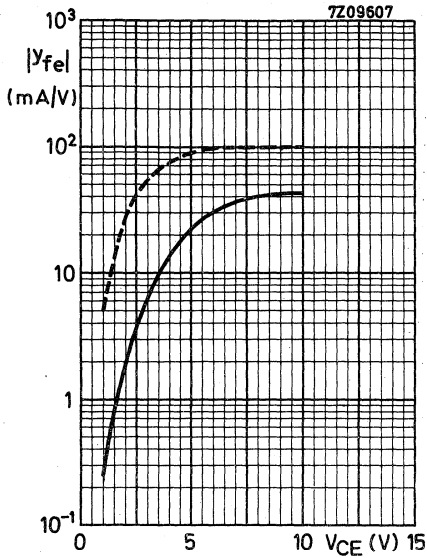

y-parameters of the equivalent gain control transistor, including base capacitor and base resistor as shown on page 4 (dashed curves apply to the transistor only).

Current control; $-V_{EE} = 20 \text{ V}$; $R_E + R_C = 1 \text{ k}\Omega$; $f = 35 \text{ MHz}$

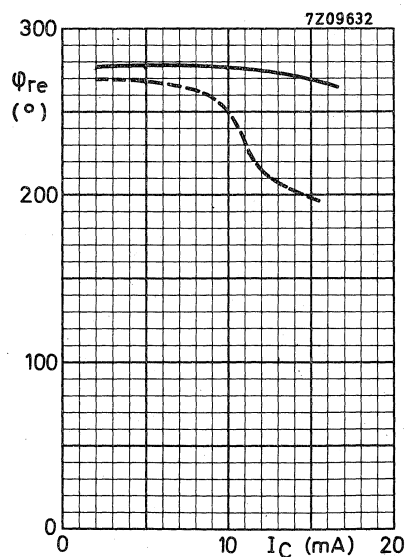
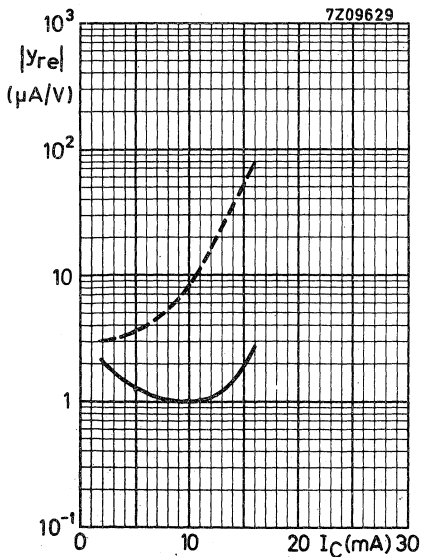
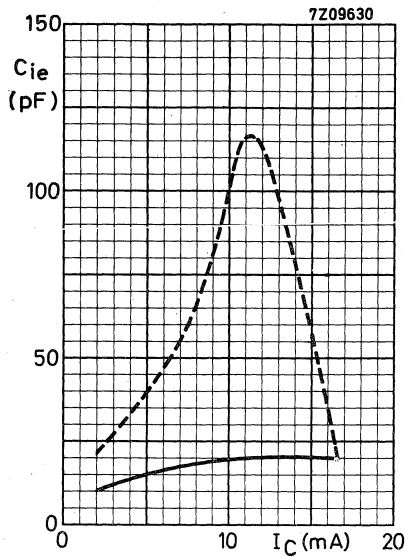
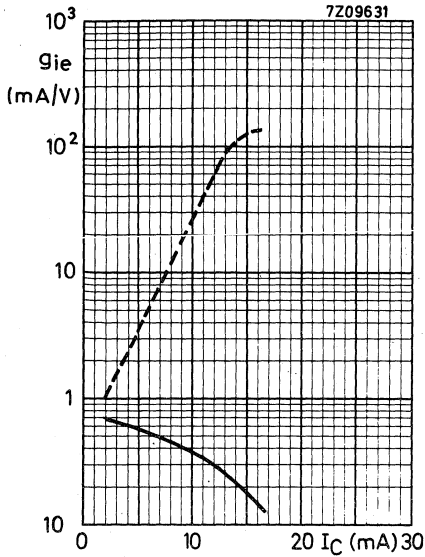

y-parameters of the equivalent gain control transistor, including base capacitor and base resistor as shown on page 4 (dashed curves apply to the transistor only).

Current control; $-V_{EE} = 20\text{ V}$; $R_E + R_C = 1\text{ k}\Omega$; $f = 35\text{ MHz}$

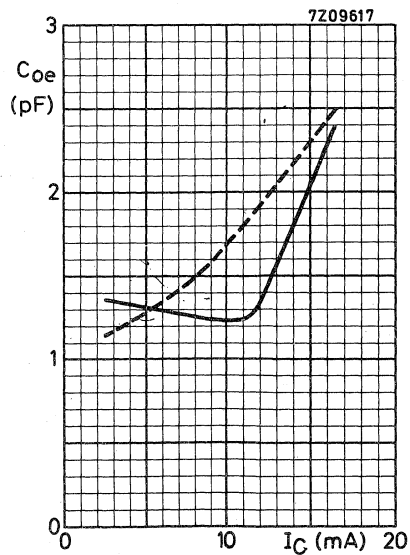
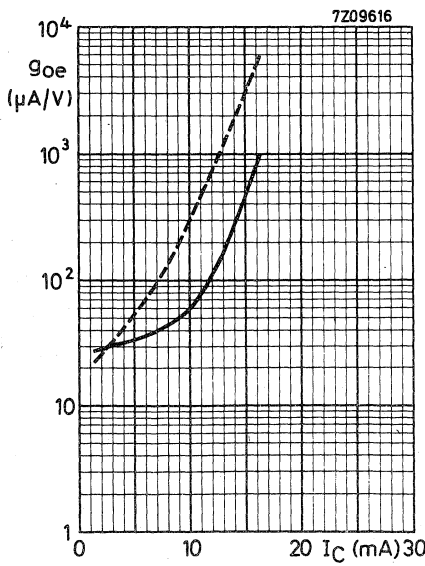
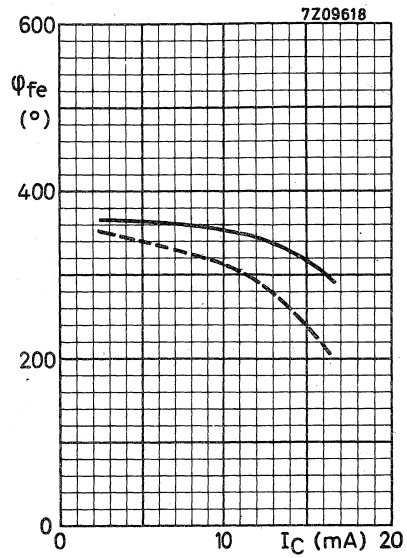
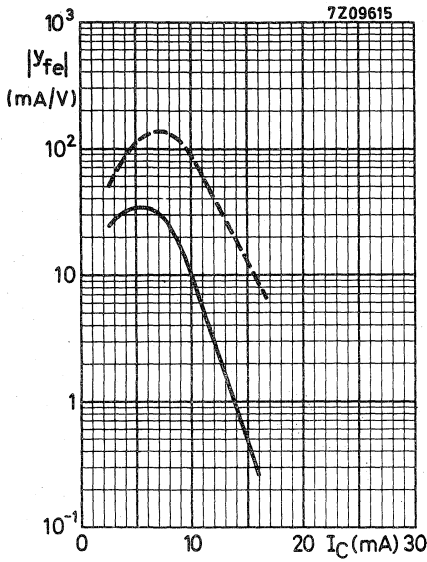

y-parameters of the equivalent gain control transistor, including base capacitor and base resistor as shown on page 4 (dashed curves apply to the transistor only).

APPLICATION INFORMATION

First stage of an i. f. amplifier

Basic circuit with voltage gain control: $R_E + R_C = 3.9 \text{ k}\Omega$; $-V_{EE} = 25 \text{ V}$

current gain control: $R_E + R_C = 1 \text{ k}\Omega$; $-V_{EE} = 20 \text{ V}$

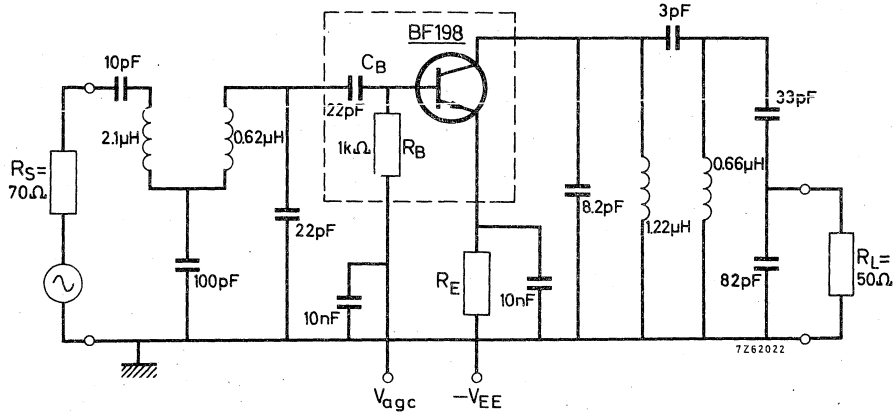

Transducer gain

$$G_{tr} \text{ (in dB)} = 10 \log \frac{\text{output power in load } R_L}{\text{available power from source } R_S}$$

$f = 36.4 \text{ MHz}$; $I_C = 4 \text{ mA}$; $R_E + R_C = 3.9 \text{ k}\Omega$; $-V_{EE} = 25 \text{ V}$ $G_{tr} \text{ typ. } 25.5 \text{ dB}$
Gain control range (see also upper graphs next page) $\Delta G_{tr} \text{ typ. } 60 \text{ dB}$

Voltage gain control

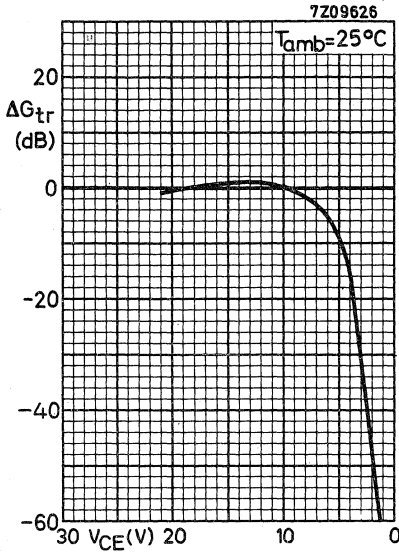

Current gain control

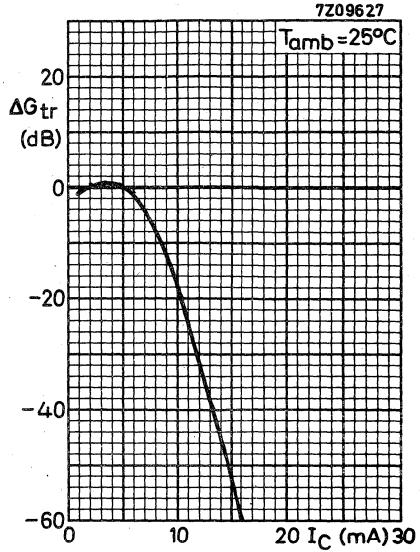

Curves of constant gain reduction

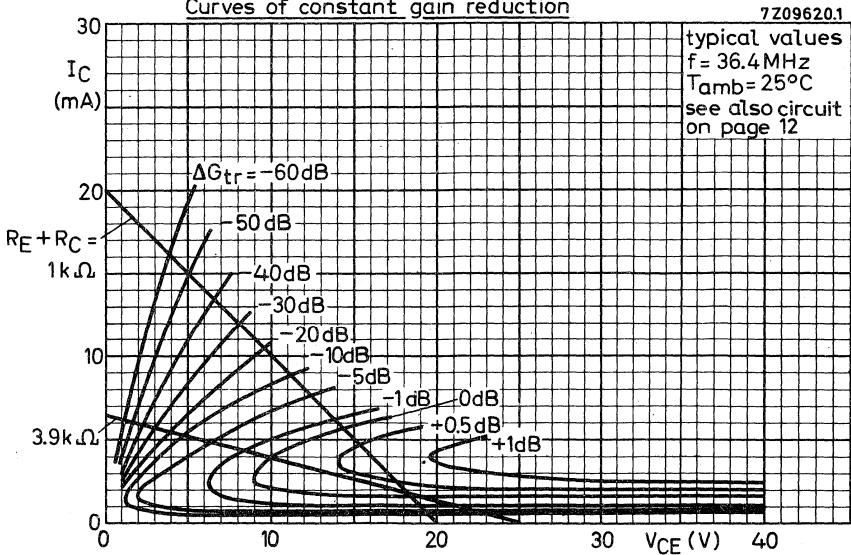



SILICON PLANAR EPITAXIAL TRANSISTOR

N-P-N transistor in a plastic TO-92 variant.

The BF199 has a very low feedback capacitance and is intended for use in the output stage of a vision i. f. amplifier.

| QUICK REFERENCE DATA | | | |
|--|-----------|------|----------------------|
| Collector-base voltage (open emitter) | V_{CBO} | max. | 40 V |
| Collector-emitter voltage (open base) | V_{CEO} | max. | 25 V |
| Collector current (d. c.) | I_C | max. | 25 mA |
| Total power dissipation up to $T_{amb} = 25\text{ }^\circ\text{C}$ | P_{tot} | max. | 500 mW |
| Junction temperature | T_j | max. | 150 $^\circ\text{C}$ |
| Transition frequency at $f = 100\text{ MHz}$ $I_C = 5\text{ mA}; V_{CE} = 10\text{ V}$ | f_T | typ. | 550 MHz |
| Feedback capacitance at $f = 10.7\text{ MHz}$ $I_C = 1\text{ mA}; V_{CE} = 10\text{ V}$ | C_{re} | typ. | 300 fF |
| Max. unilateralized power gain $I_C = 7\text{ mA}; V_{CE} = 10\text{ V}; f = 35\text{ MHz}$ | G_{UM} | typ. | 43 dB |
| $f = 45\text{ MHz}$ | G_{UM} | typ. | 41 dB |
| Video detector output voltage | V_O | typ. | 7.7 V |

MECHANICAL DATA

TO-92 variant

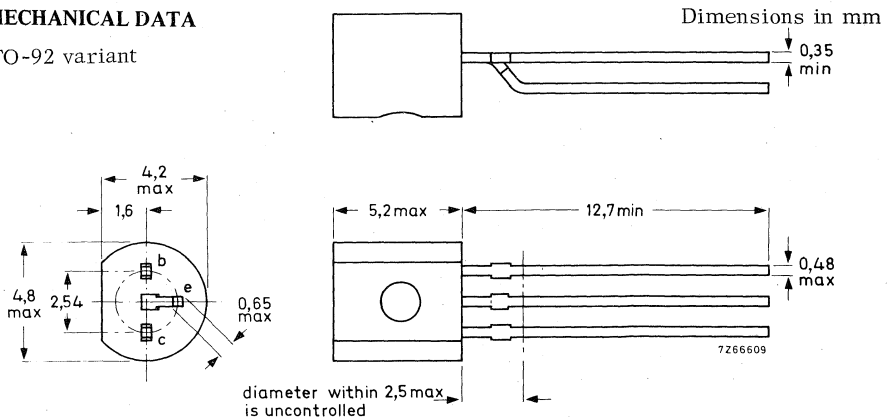

RATINGS Limiting values in accordance with the Absolute Maximum System (IEC 134)

Voltages

| | | | | |
|---------------------------------------|-----------|------|----|-----------------|
| Collector-base voltage (open emitter) | V_{CBO} | max. | 40 | V |
| Collector-emitter voltage (open base) | V_{CEO} | max. | 25 | V ¹⁾ |
| Emitter-base voltage (open collector) | V_{EBO} | max. | 4 | V |

Currents

| | | | | |
|--------------------------------|----------|------|----|----|
| Collector current (d. c.) | I_C | max. | 25 | mA |
| Collector current (peak value) | I_{CM} | max. | 25 | mA |

Power dissipation

| | | | | |
|--|-----------|------|-----|----|
| Total power dissipation up to $T_{amb} = 25^\circ C$ | P_{tot} | max. | 500 | mW |
|--|-----------|------|-----|----|

Temperatures

| | | | |
|----------------------|-----------|-------------|------------|
| Storage temperature | T_{stg} | -65 to +150 | $^\circ C$ |
| Junction temperature | T_j | max. 150 | $^\circ C$ |

THERMAL RESISTANCE

| | | | | |
|--------------------------------------|---------------|---|------|---------------|
| From junction to ambient in free air | $R_{th\ j-a}$ | = | 0.25 | $^\circ C/mW$ |
|--------------------------------------|---------------|---|------|---------------|

¹⁾ See also page 4

CHARACTERISTICS

$T_{amb} = 25^{\circ}C$ unless otherwise specified

Base current

$I_C = 7 \text{ mA}; V_{CE} = 10 \text{ V}$

| | | | |
|-------|------|-----|---------|
| I_B | typ. | 60 | μA |
| | < | 185 | μA |

Base-emitter voltage ¹⁾

$I_C = 7 \text{ mA}; V_{CE} = 10 \text{ V}$

| | | | |
|----------|------|-----|----|
| V_{BE} | typ. | 775 | mV |
| | < | 925 | mV |

Feedback capacitance at $f = 10.7 \text{ MHz}$

$I_C = 1 \text{ mA}; V_{CE} = 10 \text{ V}$

| | | | |
|----------|------|-----|----|
| C_{re} | typ. | 300 | fF |
|----------|------|-----|----|

Transition frequency at $f = 100 \text{ MHz}$

$I_C = 5 \text{ mA}; V_{CE} = 10 \text{ V}$

| | | | |
|-------|------|-----|-----|
| f_T | typ. | 550 | MHz |
|-------|------|-----|-----|

y parameters (common emitter)

$I_C = 7 \text{ mA}; V_{CE} = 10 \text{ V}$

| | | | $f = 35 \quad 45 \text{ MHz}$ | |
|------------------------------------|-------------|------|-------------------------------|---------------|
| Input conductance | g_{ie} | typ. | 4.5 | 5.5 mA/V |
| Input capacitance | C_{ie} | typ. | 45 | 45 pF |
| Feedback admittance | $ y_{re} $ | typ. | 67 | 86 $\mu A/V$ |
| Phase angle of feedback admittance | ϕ_{re} | typ. | 268° | 268° |
| Transfer admittance | $ y_{fe} $ | typ. | 170 | 155 mA/V |
| Phase angle of transfer admittance | ϕ_{fe} | typ. | 338° | 335° |
| Output conductance | g_{oe} | typ. | 85 | 95 $\mu A/V$ |
| Output capacitance | C_{oe} | typ. | 1.8 | 1.8 pF |

Maximum unilateralized power gain

$$G_{UM} \text{ (in dB)} = 10 \log \frac{|y_{fe}|^2}{4g_{ie}g_{oe}}$$

$I_C = 7 \text{ mA}; V_{CE} = 10 \text{ V}$

| | | | | |
|----------|------|----|----|----|
| G_{UM} | typ. | 43 | 41 | dB |
|----------|------|----|----|----|

¹⁾ V_{BE} decreases by about $1.7 \text{ mV}/^{\circ}C$ with increasing temperature.

7Z09597

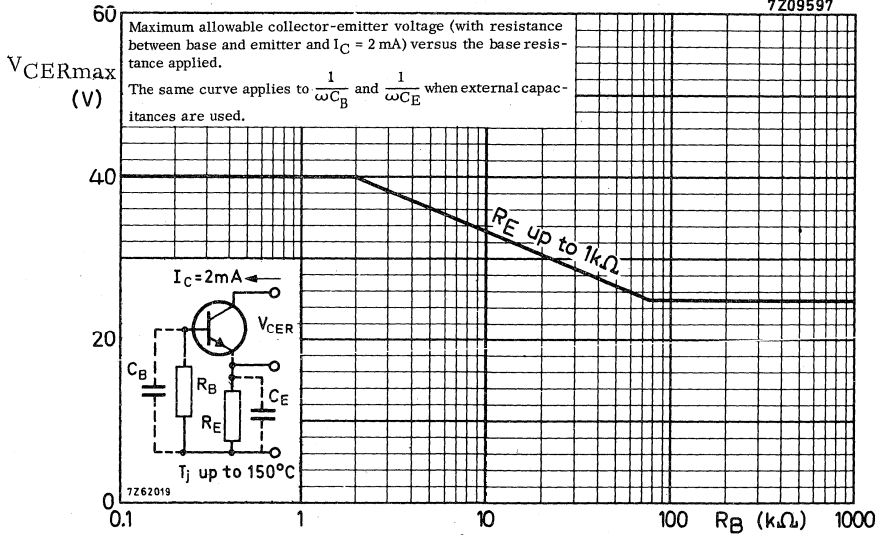

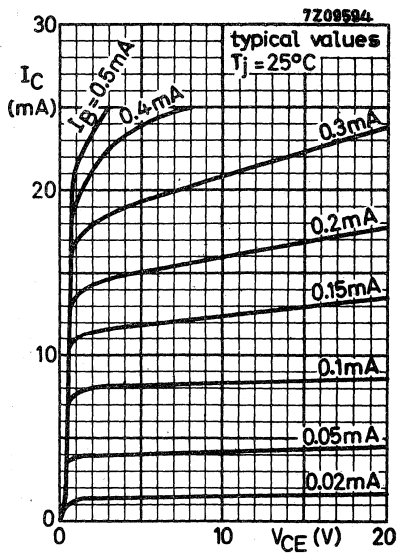
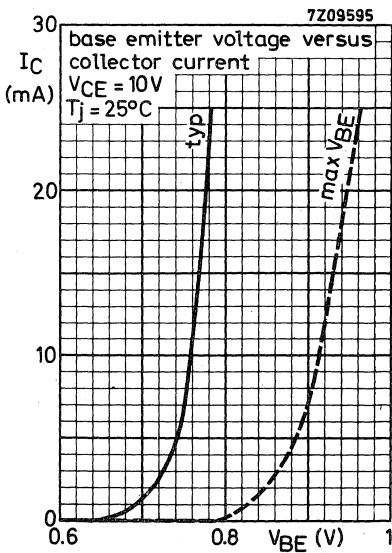
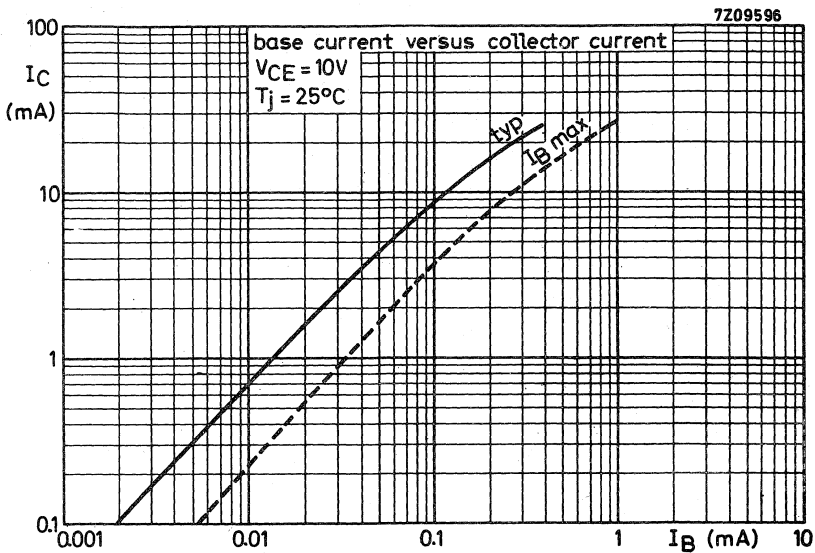

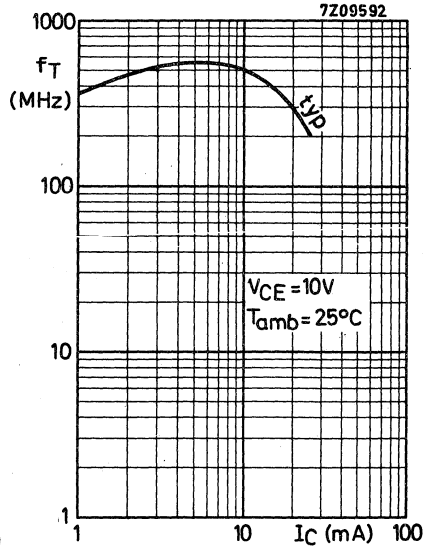
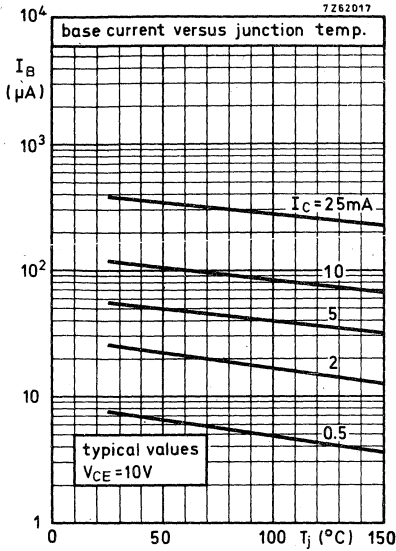

APPLICATION INFORMATION

Output stage of television video i.f. amplifier with the BF199 transistor, followed by a video detector circuit.

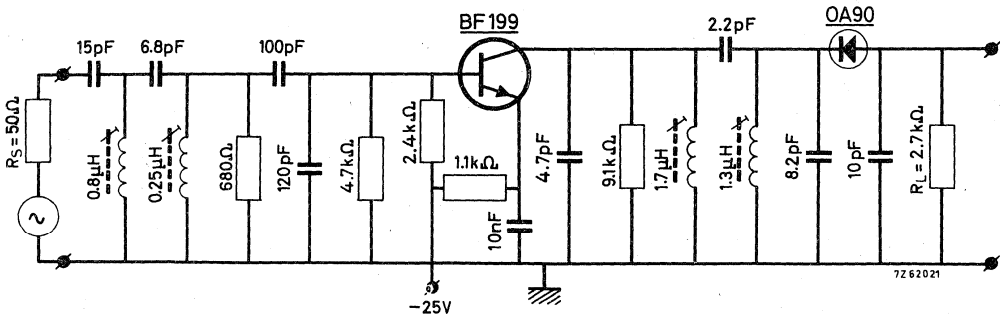

APPLICATION INFORMATION (continued)

Video detector output voltage at $f = 38.9$ MHz ¹⁾

$I_C = 7.2$ mA; $V_{CE} = 16.6$ V

$V_O > 6$ V
typ. 7.7 V

Transducer gain at $f = 36.4$ MHz

G_{tr} (in dB) = $10 \log \frac{\text{output power in load } R_L}{\text{available power from source with } R_S}$

$I_C = 7.2$ mA; $V_{CE} = 16.6$ V

G_{tr} typ. 25.5 dB

Tuning frequency for all tuned circuits is 37 MHz

¹⁾ The output voltage V_O is defined as the voltage across the 2.7 k Ω detector load R_L for 30% synchronisation pulse compression.

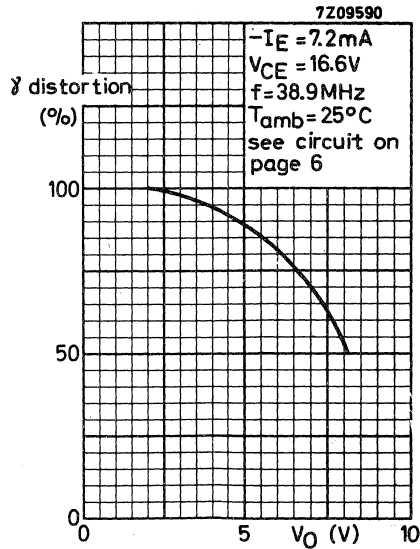
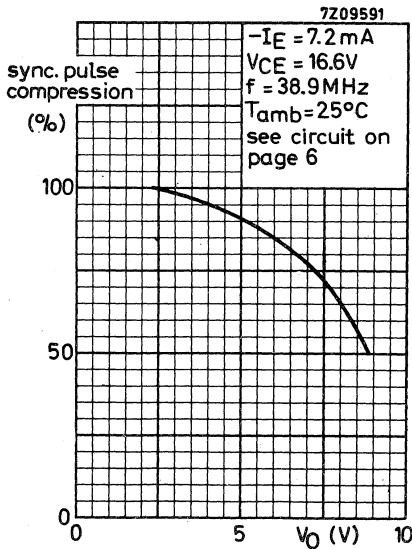

SILICON PLANAR TRANSISTOR

N-P-N transistor in a TO-72 metal envelope with insulated electrodes and a shield lead connected to the case. The BF200 is primarily intended for application in a forward gain controlled pre-amplifier in v.h.f. television tuners and f.m. tuners.

QUICK REFERENCE DATA

| | | | |
|---|-----------|------|----------------------|
| Collector-base voltage (open emitter) | V_{CBO} | max. | 30 V |
| Collector-emitter voltage (open base) | V_{CEO} | max. | 20 V |
| Collector current (d.c.) | I_C | max. | 20 mA |
| Total power dissipation up to $T_{amb} = 25\text{ }^\circ\text{C}$ | P_{tot} | max. | 150 mW |
| Junction temperature | T_j | max. | 175 $^\circ\text{C}$ |
| Transition frequency | f_T | typ. | 650 MHz |
| - $I_E = 3\text{ mA}$; $V_{CB} = 10\text{ V}$ | | | |
| Max. unilateralised power gain | G_{UM} | typ. | 30 dB |
| - $I_E = 3\text{ mA}$; $V_{CB} = 10\text{ V}$; $f = 50\text{ MHz}$ | | | |
| $f = 200\text{ MHz}$ | | | |
| | G_{UM} | typ. | 22 dB |
| Noise figure at optimum source admittance | F | typ. | 2 dB |
| - $I_E = 2\text{ mA}$; $V_{CB} = 10\text{ V}$; $f = 100\text{ MHz}$ | | | |
| | F | typ. | 2.7 dB |
| - $I_E = 3\text{ mA}$; $V_{CB} = 10\text{ V}$; $f = 200\text{ MHz}$ | | | |

MECHANICAL DATA

Dimensions in mm

TO-72

Accessories supplied on request: 56246, 56263.

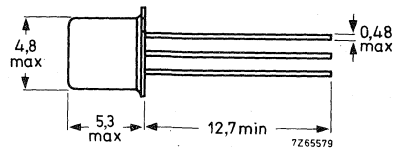
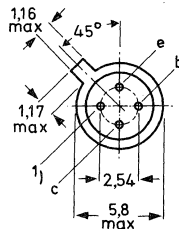

1) Shield lead connected to case.

RATINGS (Limiting values) ¹⁾Voltages

| | | | |
|---|-----------|------|------|
| Collector-base voltage (open emitter) | V_{CBO} | max. | 30 V |
| Collector-emitter voltage (open base) | V_{CEO} | max. | 20 V |
| Collector-emitter voltage ($R_{BE} \leq 1 \text{ k}\Omega$) | V_{CER} | max. | 30 V |
| Emitter-base voltage (open collector) | V_{EBO} | max. | 3 V |

Currents

| | | | |
|--------------------------------|----------|------|-------|
| Collector current (d.c.) | I_C | max. | 20 mA |
| Collector current (peak value) | I_{CM} | max. | 20 mA |

Power dissipation

| | | | |
|---|-----------|------|--------|
| Total power dissipation up to $T_{amb} = 25 \text{ }^\circ\text{C}$ | P_{tot} | max. | 150 mW |
|---|-----------|------|--------|

Temperatures

| | | | |
|----------------------|-----------|-------------|----------------------|
| Storage temperature | T_{stg} | -65 to +175 | $^\circ\text{C}$ |
| Junction temperature | T_j | max. | 175 $^\circ\text{C}$ |

THERMAL RESISTANCE

| | | | |
|--------------------------------------|----------------------|---|------------------------------|
| From junction to ambient in free air | $R_{th \text{ j-a}}$ | = | 1 $^\circ\text{C}/\text{mW}$ |
|--------------------------------------|----------------------|---|------------------------------|

¹⁾ Limiting values according to the Absolute Maximum System as defined in IEC publication 134.

CHARACTERISTICS

$T_{amb} = 25^{\circ}C$ unless otherwise specified

Base current

| | | |
|--|-------|-----------------------------------|
| $-I_E = 3 \text{ mA}; V_{CB} = 10 \text{ V}$ | I_B | typ. 100 μA < 200 μA |
| $-I_E = 12 \text{ mA}; V_{CB} = 7 \text{ V}$ | I_B | < 2.2 mA |

Emitter-base voltage

| | | |
|--|-----------|-------------|
| $-I_E = 3 \text{ mA}; V_{CB} = 10 \text{ V}$ | $-V_{EB}$ | typ. 0.75 V |
| $-I_E = 12 \text{ mA}; V_{CB} = 7 \text{ V}$ | $-V_{EB}$ | < 1.0 V |

Transition frequency

| | | |
|--|-------|--------------|
| $-I_E = 3 \text{ mA}; V_{CB} = 10 \text{ V}$ | f_T | typ. 650 MHz |
|--|-------|--------------|

Feedback capacitance at $f = 10.7 \text{ MHz}$

| | | |
|---|----------|---------------------------|
| $I_C = 1 \text{ mA}; V_{CE} = 10 \text{ V}$ | C_{re} | typ. 280 fF ¹⁾ |
|---|----------|---------------------------|

Noise figure at optimum source admittance

| | | |
|---|---|-------------|
| $-I_E = 3 \text{ mA}; V_{CB} = 10 \text{ V}; f = 50 \text{ MHz}$ | F | typ. 1.9 dB |
| $f = 200 \text{ MHz}$ | F | typ. 2.7 dB |
| $-I_E = 2 \text{ mA}; V_{CB} = 10 \text{ V}; f = 100 \text{ MHz}$ | F | typ. 2.0 dB |

Maximum unilateralised power gain²⁾

$$GUM = \frac{|y_{fb}|^2}{4 g_{ib}g_{ob}}$$

| | | |
|---|-----|------------|
| $-I_E = 3 \text{ mA}; V_{CB} = 10 \text{ V}; f = 50 \text{ MHz}$ | GUM | typ. 30 dB |
| $f = 200 \text{ MHz}$ | GUM | typ. 22 dB |
| $-I_E = 2 \text{ mA}; V_{CB} = 10 \text{ V}; f = 100 \text{ MHz}$ | GUM | typ. 28 dB |

1) 1 fF = 1 femtofarad = 10^{-15} F .

2) Commonbase configuration, metal envelope connected to earth directly, external lead length = 3 mm.

CHARACTERISTICS (continued)

$T_{amb} = 25\text{ }^{\circ}\text{C}$ unless otherwise specified

y parameters at $f = 100\text{ MHz}$ (common emitter)

$I_C = 2\text{ mA}; V_{CE} = 10\text{ V}$

| | | | | |
|------------------------------------|-------------|------|----------------|-----------------------|
| Input conductance | g_{ie} | typ. | 5 | $\text{m}\Omega^{-1}$ |
| Input capacitance | C_{ie} | typ. | 16 | pF |
| Feedback admittance | $ y_{re} $ | typ. | 0.16 | $\text{m}\Omega^{-1}$ |
| Phase angle of feedback admittance | ϕ_{re} | typ. | 270 $^{\circ}$ | |
| Transfer admittance | $ y_{fe} $ | typ. | 56 | $\text{m}\Omega^{-1}$ |
| Phase angle of transfer admittance | ϕ_{fe} | typ. | 340 $^{\circ}$ | |
| Output conductance | g_{oe} | typ. | 15 | $\mu\Omega^{-1}$ |
| Output capacitance | C_{oe} | typ. | 0.9 | pF |

y parameters at $f = 50\text{ MHz}$ (common base)

$-I_E = 3\text{ mA}; V_{CB} = 10\text{ V}$

| | | | | |
|------------------------------------|-------------|------|----------------|-----------------------|
| Input conductance | g_{ib} | typ. | 85 | $\text{m}\Omega^{-1}$ |
| Input susceptance | $-b_{ib}$ | typ. | 15 | $\text{m}\Omega^{-1}$ |
| Feedback admittance | $ y_{rb} $ | typ. | 55 | $\mu\Omega^{-1}$ |
| Phase angle of feedback admittance | ϕ_{rb} | typ. | 270 $^{\circ}$ | |
| Transfer admittance | $ y_{fb} $ | typ. | 85 | $\text{m}\Omega^{-1}$ |
| Phase angle of transfer admittance | ϕ_{fb} | typ. | 165 $^{\circ}$ | |
| Output conductance | g_{ob} | typ. | 15 | $\mu\Omega^{-1}$ |
| Output susceptance | b_{ob} | typ. | 280 | $\mu\Omega^{-1}$ |

y parameters at $f = 200\text{ MHz}$ (common base)

$-I_E = 3\text{ mA}; V_{CB} = 10\text{ V}$

| | | | | |
|------------------------------------|-------------|------|----------------|-----------------------|
| Input conductance | g_{ib} | typ. | 62 | $\text{m}\Omega^{-1}$ |
| Input susceptance | $-b_{ib}$ | typ. | 38 | $\text{m}\Omega^{-1}$ |
| Feedback admittance | $ y_{rb} $ | typ. | 180 | $\mu\Omega^{-1}$ |
| Phase angle of feedback admittance | ϕ_{rb} | typ. | 270 $^{\circ}$ | |
| Transfer admittance | $ y_{fb} $ | typ. | 70 | $\text{m}\Omega^{-1}$ |
| Phase angle of transfer admittance | ϕ_{fb} | typ. | 145 $^{\circ}$ | |
| Output conductance | g_{ob} | typ. | 150 | $\mu\Omega^{-1}$ |
| Output susceptance | b_{ob} | typ. | 1.1 | $\text{m}\Omega^{-1}$ |

circles of constant noise figure

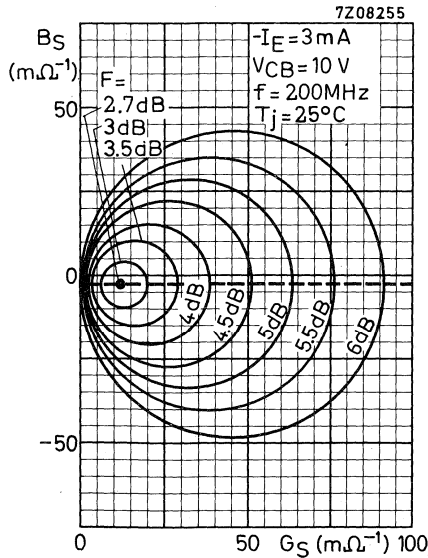
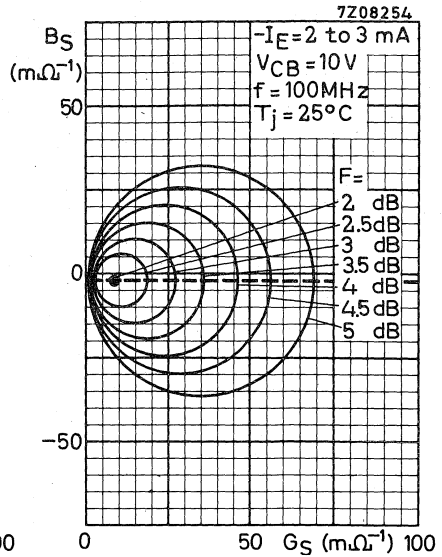
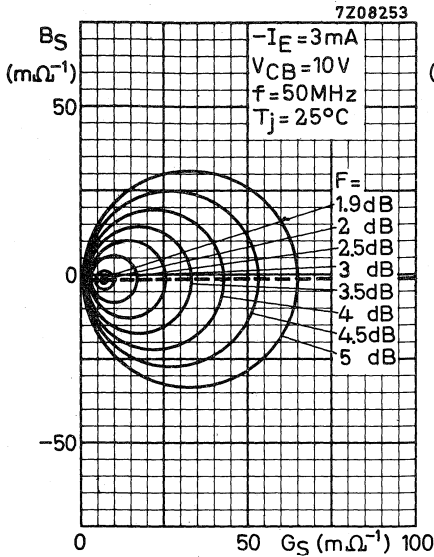

7207931

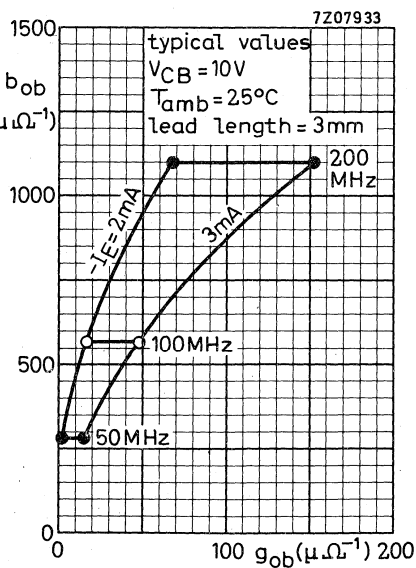
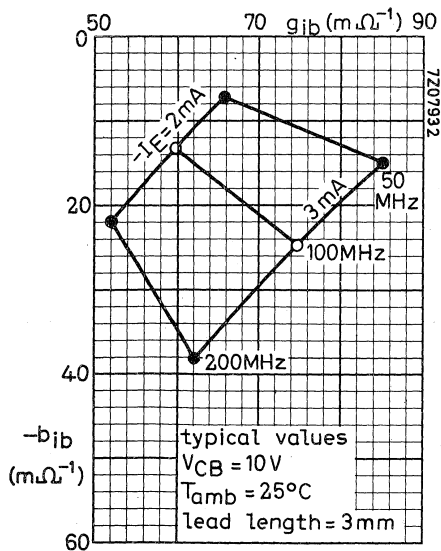
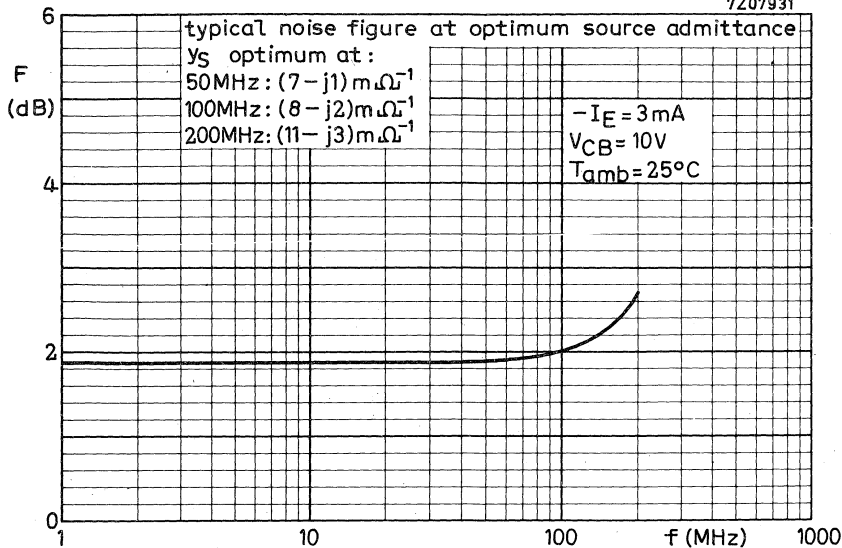

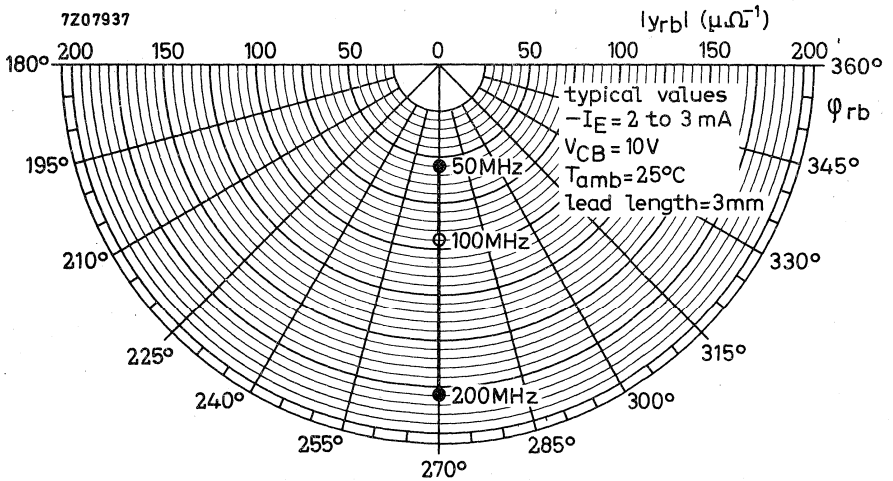
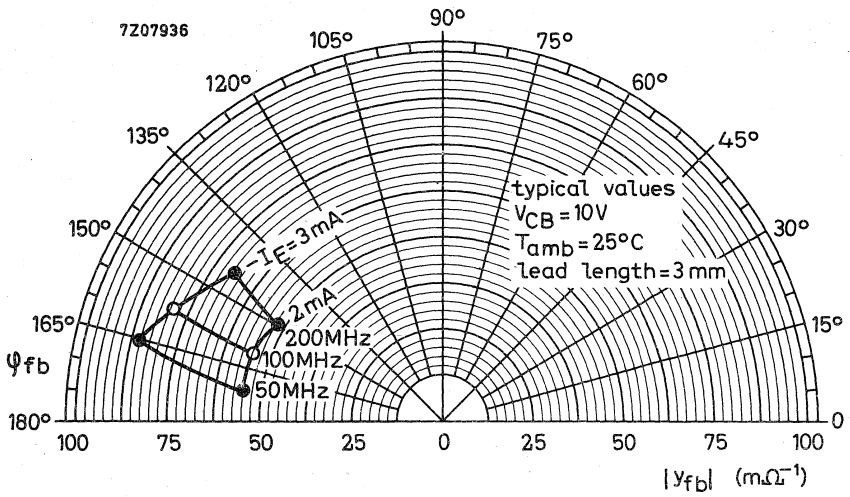

7Z07919

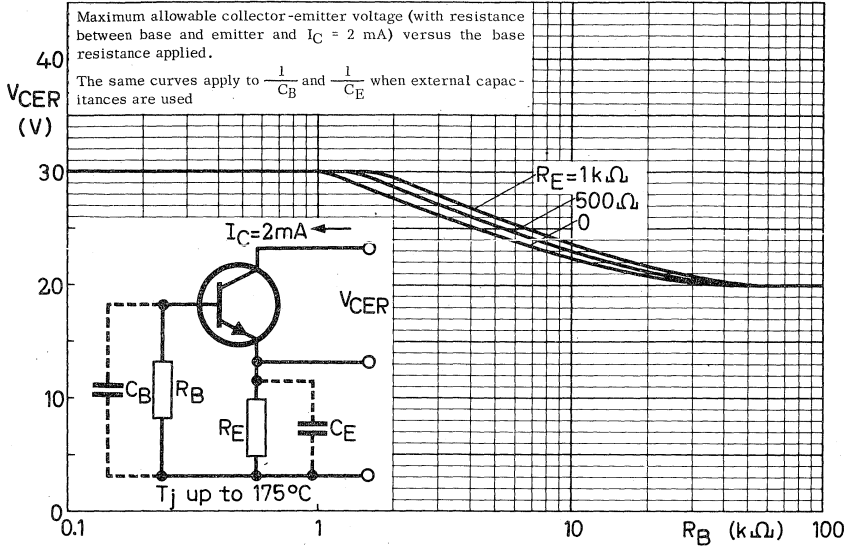

APPLICATION INFORMATION

1. R.F. stage for v.h.f. television tuner

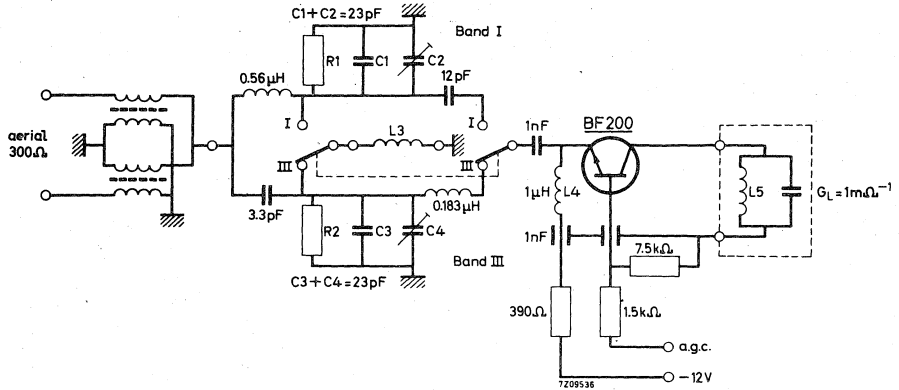

Resistors R_1 and R_2 should be chosen so that the 3 dB bandwidth of the unloaded input circuit is 3.0 MHz with the aerial and transistor input terminals short-circuited.

Inductors L_3 and L_5 to be selected for each channel.

PERFORMANCE at $T_{amb} = 25\text{ }^\circ\text{C}$ (see circuit above)

Transducer gain

$$G_{tr} = \frac{\text{output power in load } G_L}{\text{available power from aerial}}$$

$-I_E = 3\text{ mA}; f = 50\text{ MHz}$

G_{tr} typ. 13 dB

$-I_E = 3\text{ mA}; f = 200\text{ MHz}$

G_{tr} typ. 13 dB

Noise figure

$f = 50\text{ MHz}$

F typ. 4.9 dB

$f = 200\text{ MHz}$

F typ. 5.2 dB

Voltage standing wave ratio over the entire gain control range, measured at the vision carrier frequency

V.S.W.R. < 4

APPLICATION INFORMATION (continued)

Signal-handling capability (see next page)

In-channel cross-modulation curves of the tuner (see upper graphs); showing the interfering signal e.m.f. (in a 300 Ω aerial) that will cause a cross-modulation factor of 1% (K), plotted against ΔG_{tr} , the reduction in transducer gain caused by gain control. The broken lines indicate the signal level, assuming that gain control starts when desired aerial signal reaches 2 mV.

Measuring conditions

Desired signal at vision carrier frequency and interference signal at sound carrier frequency. Interference signal modulated with 4 kHz (modulation depth 100%).

In-band cross-modulation curves of the tuner; showing the interfering signal e.m.f. (in a 300 Ω aerial) that will cause a cross-modulation factor of 1% (K), plotted against ΔG_{tr} , the reduction in transducer gain caused by gain control.

Measuring conditions

Desired signal at the vision carrier frequency and interference signal, 14 MHz above the desired signal. Interference signal modulated with 4 kHz (modulation depth 100%).

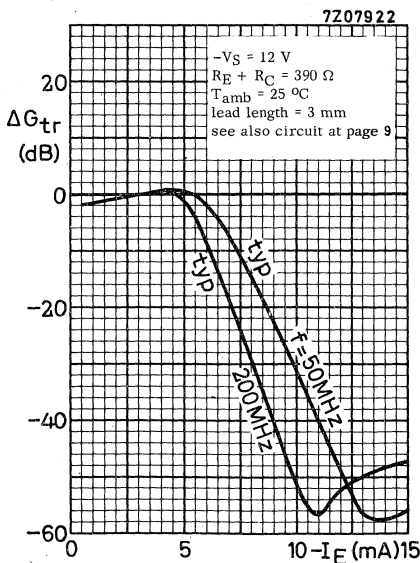
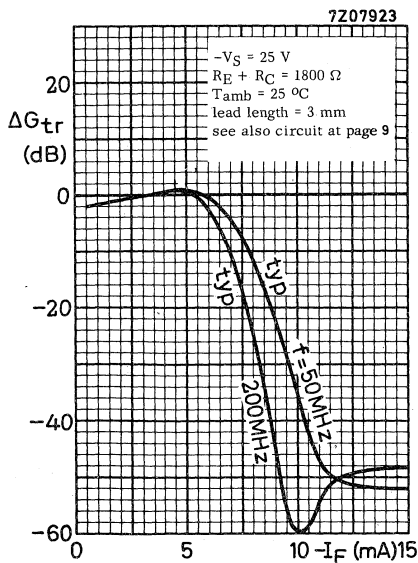

APPLICATION INFORMATION (continued)

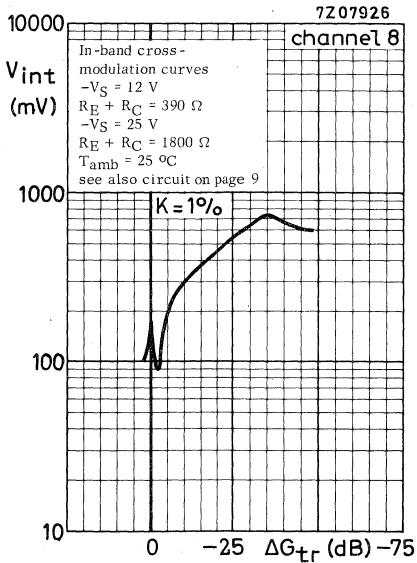
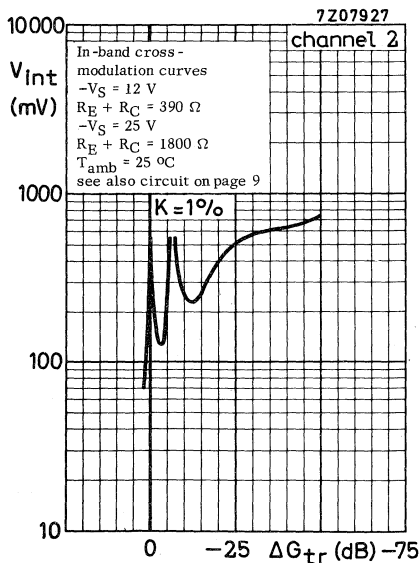
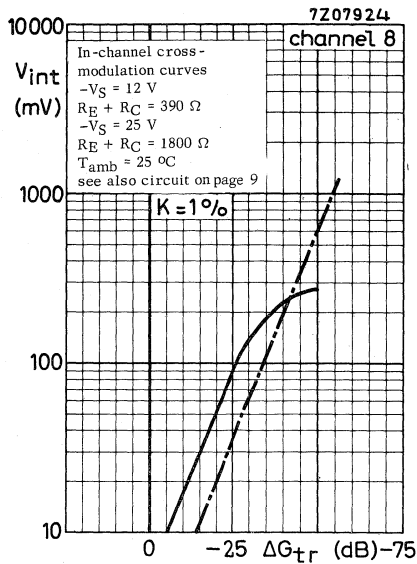
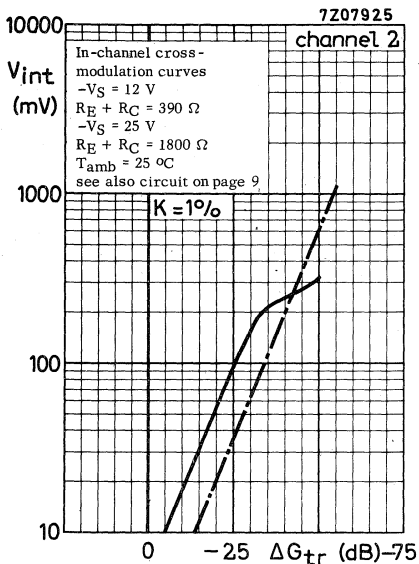

APPLICATION INFORMATION (continued)
curves of constant gain reduction

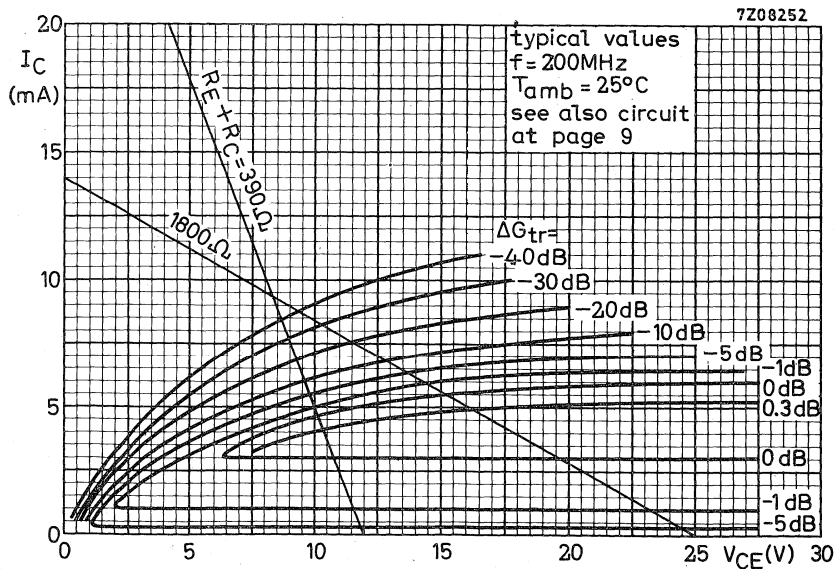
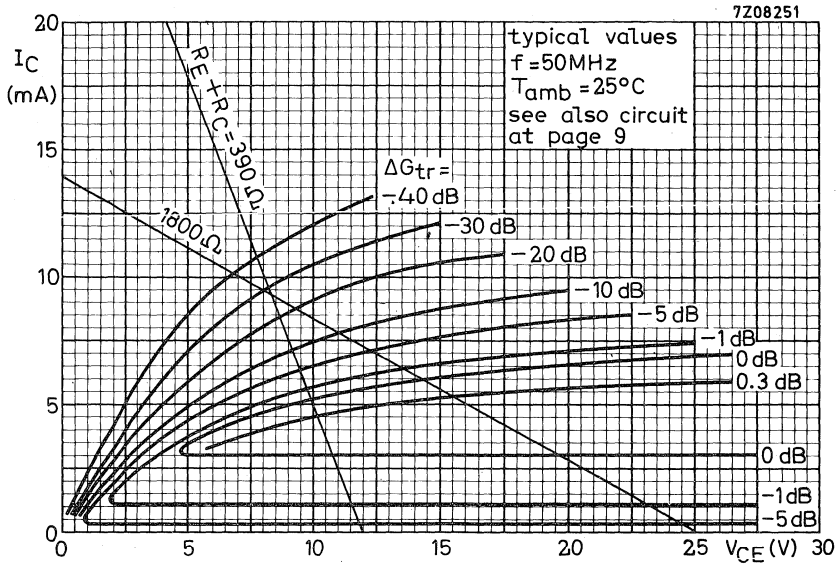

APPLICATION INFORMATION (continued)

2. F.M. tuner with a BF200 in the pre-amplifier stage.

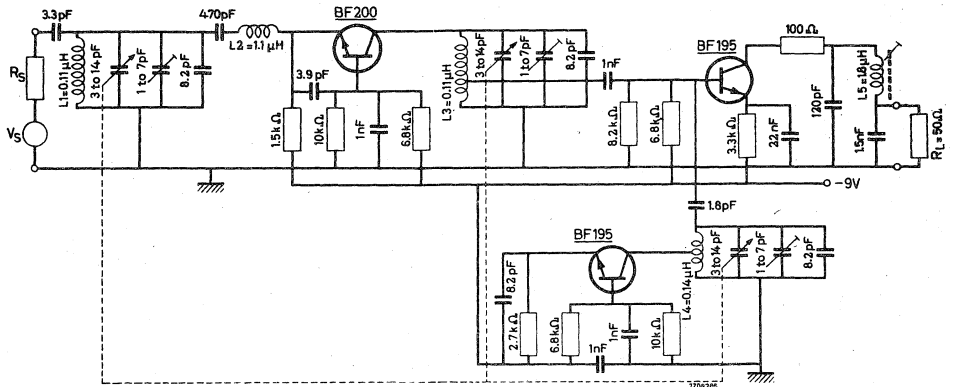

Coil data:

- L1 = 4 turns enamelled Cu wire (1 mm); int. diam. 8 mm; winding pitch 2 mm; air; $Q_0 = 200$; $Q_L = 50$
 - L2 = 22 turns closely wound enamelled Cu wire (0.2 mm); int. diam. 4 mm; $Q_0 = 150$
 - L3 = 4 turns enamelled Cu wire (1 mm); int. diam. 8 mm; winding pitch 2 mm; air; mixer base tap 3/4 turns from earth-side; $Q_0 = 200$; $Q_L = 100$
 - L4 = 4.5 turns enamelled Cu wire (1 mm); int. diam. 8 mm; winding pitch 2 mm; air; oscillator collector tap 3.5 turns from earth-side; $Q_0 = 200$
 - L5 = 11 turns enamelled Cu wire (0.2 mm); winding pitch 0.4 mm; $Q_0 = 150$
- | | | | |
|-------------|-----------|------------------|----------------|
| Coil former | AP3016/02 | Ferroxcube core | 3122 104 93041 |
| Can | AP3015/02 | Ferroxcube frame | AP3014/02 |

APPLICATION INFORMATION (continued)

Typical performance of the f.m. tuner at $T_{amb} = 25\text{ }^{\circ}\text{C}$; $f = 98\text{ MHz}$ (oscillator frequency lower than tuning frequency)

| | | | |
|---|------------------|------|-----|
| Noise figure | F | 4.5 | dB |
| Transducer gain $G_{tr} = \frac{\text{output power in load}}{\text{available power from source}}$ | G_{tr} | 33 | dB |
| Image rejection | | 65 | dB |
| Double beat suppression ($V_S = 1\text{ }\mu\text{V}$; emf; $R_S = 50\text{ }\Omega$) | | 85 | dB |
| Repeat spot suppression ($V_S = 1\text{ }\mu\text{V}$; emf; $R_S = 50\text{ }\Omega$) | | 87 | dB |
| Oscillator frequency variation at $\Delta V_B = 2\text{ V}$ | Δf_{osc} | < 20 | kHz |
| Signal handling for $\Delta f_{osc} = 20\text{ kHz}$ (emf; $R_S = 50\text{ }\Omega$) | | > 1 | V |

Double beat suppression

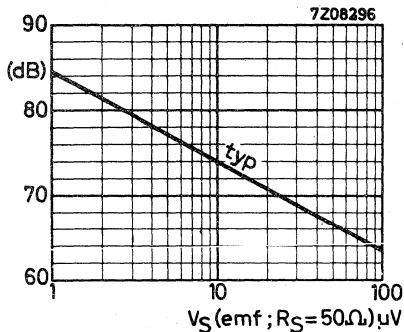

Repeat spot suppression

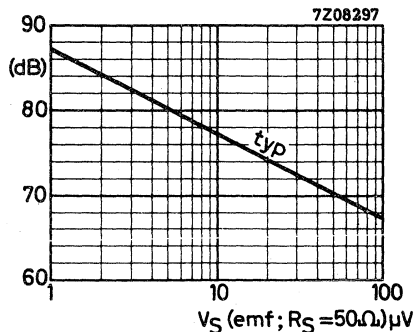

Spurious response suppression

Tuner adjusted to $f = 98\text{ MHz}$.

Reference level of wanted source signal: $8\text{ }\mu\text{V}$ (emf; $R_S = 50\text{ }\Omega$) = 0 dB.

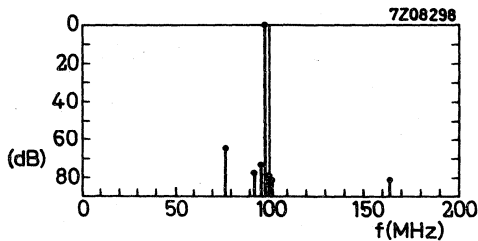

H.F. SILICON PLANAR EPITAXIAL TRANSISTORS

N-P-N transistors in a plastic envelope, recommended for a.m. mixers and i.f. amplifiers in a.m./f.m. receivers.

| QUICK REFERENCE DATA | | | | |
|--|-----------|------|-----------------------------|--------------------|
| Collector-base voltage (open emitter) | V_{CBO} | max. | 40 | V |
| Collector-emitter voltage (open base) | V_{CEO} | max. | 40 | V |
| Collector current (d.c.) | I_C | max. | 25 | mA |
| Total power dissipation up to $T_{amb} = 25\text{ }^\circ\text{C}$ | P_{tot} | max. | 250 | mW |
| Junction temperature | T_j | max. | 125 | $^\circ\text{C}$ |
| Base current | | | <u>BF240</u> <u>BF241</u> | |
| $I_C = 1\text{ mA}; V_{CE} = 10\text{ V}$ | I_B | | 4, 5-15 | 8-28 μA |
| Transition frequency | | | | |
| $I_C = 1\text{ mA}; V_{CE} = 10\text{ V}$ | f_T | typ. | 380 | 350 MHz |
| Feedback capacitance at $f = 1\text{ MHz}$ | | | | |
| $I_C = 1\text{ mA}; V_{CE} = 10\text{ V}$ | C_{re} | < | 0, 34 | pF |
| Noise figure | | | | |
| $I_C = 1\text{ mA}; V_{CE} = 10\text{ V}$ | | | | |
| $R_S = 200\ \Omega; f = 0, 2\text{ MHz}$ | F | < | 3, 5 | dB |

MECHANICAL DATA

Dimensions in mm

TO-92 variant

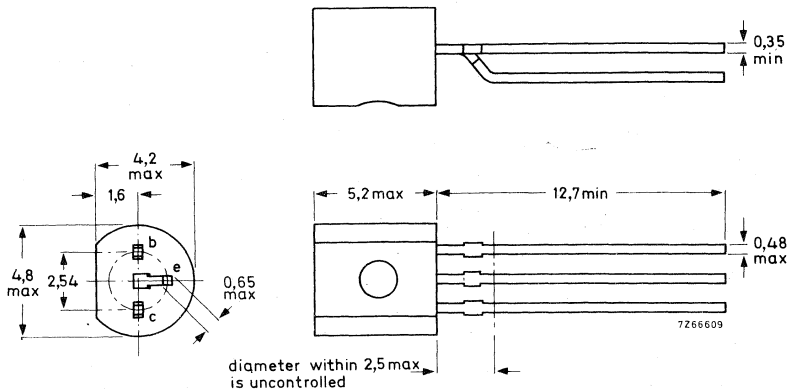

BF240
BF241

RATINGS Limiting values in accordance with the Absolute Maximum System (IEC 134)

Voltages

| | | | | |
|---------------------------------------|-----------|------|----|---|
| Collector-base voltage (open emitter) | V_{CBO} | max. | 40 | V |
| Collector-emitter voltage (open base) | V_{CEO} | max. | 40 | V |
| Emitter-base voltage (open collector) | V_{EBO} | max. | 4 | V |

Current

| | | | | |
|--------------------------|-------|------|----|----|
| Collector current (d.c.) | I_C | max. | 25 | mA |
|--------------------------|-------|------|----|----|

Power dissipation

| | | | | |
|--|-----------|------|-----|----|
| Total power dissipation up to $T_{amb} = 25^\circ C$ | P_{tot} | max. | 250 | mW |
|--|-----------|------|-----|----|

Temperatures

| | | | | |
|----------------------|-----------|------|-------------|------------|
| Storage temperature | T_{stg} | | -55 to +125 | $^\circ C$ |
| Junction temperature | T_j | max. | 125 | $^\circ C$ |

THERMAL RESISTANCE

| | | | | |
|--------------------------------------|--------------|---|-----|---------------|
| From junction to ambient in free air | $R_{th j-a}$ | = | 0,4 | $^\circ C/mW$ |
|--------------------------------------|--------------|---|-----|---------------|

CHARACTERISTICS

$T_j = 25^\circ C$ unless otherwise specified

Collector cut-off current

| | | | | |
|--------------------------|-----------|---|-----|----|
| $I_E = 0; V_{CB} = 20 V$ | I_{CBO} | < | 100 | nA |
|--------------------------|-----------|---|-----|----|

Base-emitter voltage

| | | | | |
|-----------------------------|----------|------|------------|----|
| $I_C = 1 mA; V_{CE} = 10 V$ | V_{BE} | typ. | 700 | mV |
| | | | 650 to 740 | mV |

Base current

| | | | | | |
|-----------------------------|-------|--|--------------|--------------|---------|
| $I_C = 1 mA; V_{CE} = 10 V$ | I_B | | BF240 | BF241 | |
| | | | 4, 5-15 | 8-28 | μA |

Transition frequency at $f = 100 MHz$

| | | | | | |
|-----------------------------|-------|------|-----|-----|-----|
| $I_C = 1 mA; V_{CE} = 10 V$ | f_T | typ. | 380 | 350 | MHz |
|-----------------------------|-------|------|-----|-----|-----|

Feedback capacitance at $f = 1 MHz$

| | | | | | |
|-----------------------------|----------|------|------|------|----|
| $I_C = 1 mA; V_{CE} = 10 V$ | C_{re} | typ. | 0,27 | 0,27 | pF |
| | | < | 0,34 | 0,34 | pF |

Noise figure

| | | | | | |
|---------------------------------|---|------|-----|-----|----|
| $I_C = 1 mA; V_{CE} = 10 V$ | | | | | |
| $R_S = 200 \Omega; f = 0,2 MHz$ | F | typ. | 1,5 | 2,0 | dB |
| | | < | 3,5 | 3,5 | dB |

CHARACTERISTICS (continued)

$T_j = 25^\circ\text{C}$ unless otherwise specified

y parameters (common emitter) Lead length = 3 mm

$I_C = 1\text{ mA}; V_{CE} = 10\text{ V}$

| | f | = | BF240 | | BF241 | | MHz |
|------------------------------------|-------------|------|-------------|-------------|-------------|-------------|-----------------|
| | | | 0,45 | 10,7 | 0,45 | 10,7 | |
| Input conductance | g_{ie} | typ. | 0,2 | 0,3 | 0,4 | 0,5 | mA/V |
| Input capacitance | C_{ie} | typ. | 17 | 14 | 23 | 19 | pF |
| Transfer admittance | $ y_{fe} $ | typ. | 37 | 37 | 37 | 37 | mA/V |
| Phase angle of transfer admittance | ϕ_{fe} | typ. | 0° | 0° | 0° | 0° | |
| Output conductance | g_{oe} | < | 8,3 | 10,5 | 8,3 | 10,5 | $\mu\text{A/V}$ |
| Output capacitance | C_{oe} | typ. | 1 | 1 | 1 | 1 | pF |
| Feedback admittance | $ y_{re} $ | typ. | 0,75 | 18 | 0,75 | 18 | $\mu\text{A/V}$ |
| Phase angle of feedback admittance | ϕ_{re} | typ. | 270° | 270° | 270° | 270° | |

$I_C = 4\text{ mA}; V_{CE} = 10\text{ V}; f = 35\text{ MHz}$ (BF240, BF241)

| | | | | | | | |
|---------------------|------------|------|-----|--|--|--|-----------------|
| Input conductance | g_{ie} | typ. | 4 | | | | mA/V |
| Input capacitance | C_{ie} | typ. | 25 | | | | pF |
| Transfer admittance | $ y_{fe} $ | typ. | 125 | | | | mA/V |
| Output conductance | g_{oe} | typ. | 62 | | | | $\mu\text{A/V}$ |
| Output capacitance | C_{oe} | typ. | 1 | | | | pF |

BF240
BF241

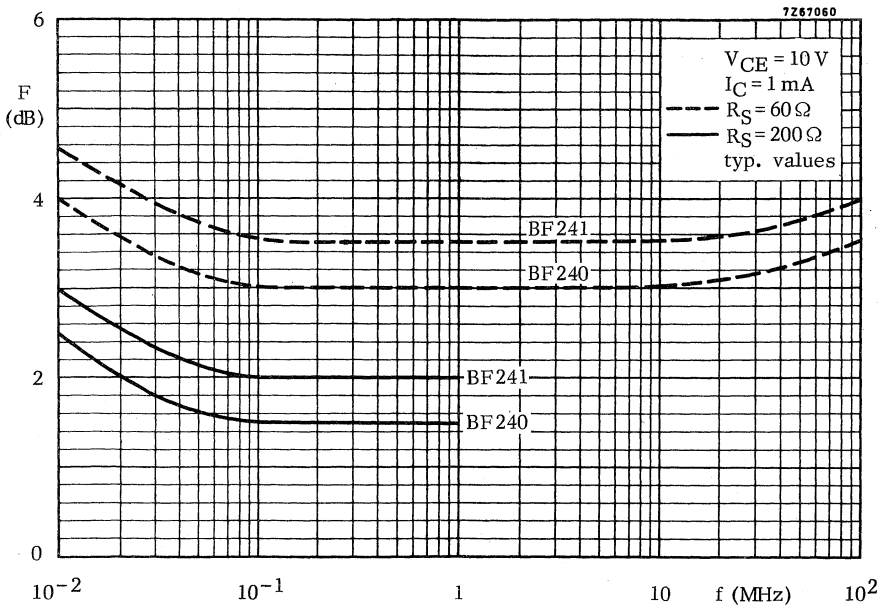
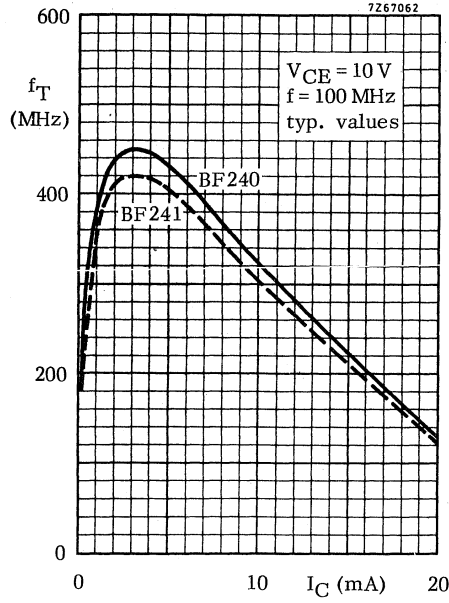

H.F. SILICON PLANAR EPITAXIAL TRANSISTOR

P-N-P transistor in a plastic envelope especially intended for r.f. stages in f.m. front-ends in common base configuration.

| QUICK REFERENCE DATA | | | |
|---|------------|------|----------------------|
| Collector-base voltage (open emitter) | $-V_{CBO}$ | max. | 30 V |
| Collector-emitter voltage (open base) | $-V_{CEO}$ | max. | 30 V |
| Collector current (d. c.) | $-I_C$ | max. | 25 mA |
| Total power dissipation up to $T_{amb} = 45\text{ }^\circ\text{C}$ | P_{tot} | max. | 250 mW |
| Junction temperature | T_j | max. | 150 $^\circ\text{C}$ |
| Base current | | | |
| $-I_C = 4\text{ mA}; -V_{CE} = 10\text{ V}$ | $-I_B$ | typ. | 80 μA |
| | | < | 160 μA |
| Transition frequency | | | |
| $-I_C = 4\text{ mA}; -V_{CE} = 10\text{ V}$ | f_T | typ. | 450 MHz |
| Noise figure at $f = 100\text{ MHz}$ | | | |
| $-I_C = 2\text{ mA}; -V_{CE} = 10\text{ V}; G_S = 16,7\text{ mA/V}$ | F | typ. | 3 dB |
| Feedback capacitance at $f = 1\text{ MHz}$ | | | |
| $V_{EB} = 0; -V_{CB} = 10\text{ V}$ | C_{rb} | typ. | 0,1 pF |

MECHANICAL DATA

Dimensions in mm

TO-92 variant

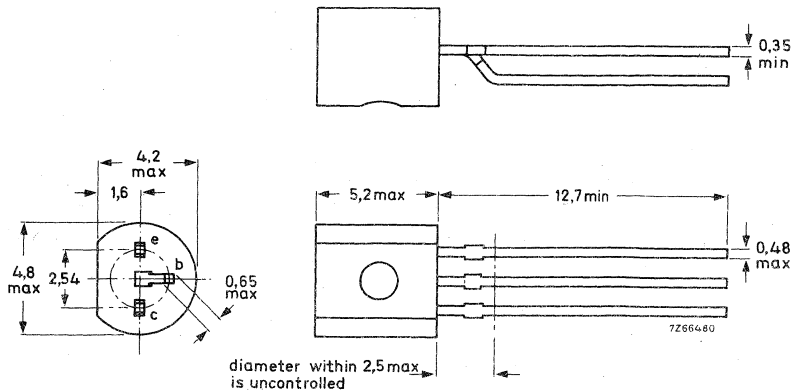

RATINGS Limiting values in accordance with the Absolute Maximum System (IEC 134)

Voltages

| | | | | |
|---------------------------------------|------------|------|----|---|
| Collector-base voltage (open emitter) | $-V_{CBO}$ | max. | 30 | V |
| Collector-emitter voltage (open base) | $-V_{CEO}$ | max. | 30 | V |
| Emitter-base voltage (open collector) | $-V_{EBO}$ | max. | 4 | V |

Current

| | | | | |
|---------------------------|--------|------|----|----|
| Collector current (d. c.) | $-I_C$ | max. | 25 | mA |
|---------------------------|--------|------|----|----|

Power dissipation

| | | | | |
|--|-----------|------|-----|----|
| Total power dissipation up to $T_{amb} = 45\text{ }^{\circ}\text{C}$ | P_{tot} | max. | 250 | mW |
|--|-----------|------|-----|----|

Temperatures

| | | | |
|----------------------|-----------|-------------|--------------------|
| Storage temperature | T_{stg} | -55 to +150 | $^{\circ}\text{C}$ |
| Junction temperature | T_j | max. 150 | $^{\circ}\text{C}$ |

THERMAL RESISTANCE

| | | | | |
|--------------------------------------|---------------|---|------|------------------------------|
| From junction to ambient in free air | $R_{th\ j-a}$ | = | 0,42 | $^{\circ}\text{C}/\text{mW}$ |
|--------------------------------------|---------------|---|------|------------------------------|

$T_j = 25\text{ }^\circ\text{C}$

CHARACTERISTICS

Collector cut-off current

$I_E = 0; -V_{CB} = 30\text{ V}$ $-I_{CBO} < 50\text{ nA}$

Emitter cut-off current

$I_C = 0; -V_{EB} = 4\text{ V}$ $-I_{EBO} < 10\text{ }\mu\text{A}$

Base current

$-I_C = 4\text{ mA}; -V_{CE} = 10\text{ V}$ $-I_B$ typ. 80 μA
 $< 160\text{ }\mu\text{A}$

$-I_C = 1\text{ mA}; -V_{CE} = 10\text{ V}$ $-I_B$ typ. 22 μA

Base-emitter voltage

$-I_C = 4\text{ mA}; -V_{CE} = 10\text{ V}$ $-V_{BE}$ typ. 0,76 V

Transition frequency at $f = 100\text{ MHz}$

$-I_C = 1\text{ mA}; -V_{CE} = 10\text{ V}$ f_T typ. 350 MHz

$-I_C = 4\text{ mA}; -V_{CE} = 10\text{ V}$ f_T typ. 450 MHz

$-I_C = 8\text{ mA}; -V_{CE} = 10\text{ V}$ f_T typ. 440 MHz

Feedback capacitance at $f = 1\text{ MHz}$

$V_{EB} = 0; -V_{CB} = 10\text{ V}$ C_{rb} typ. 0,1 pF

Noise factor at $f = 100\text{ MHz}$

$-I_C = 2\text{ mA}; -V_{CE} = 10\text{ V};$
 $G_S = 16,7\text{ mA/V}$ F typ. 3 dB

$-I_C = 5\text{ mA}; -V_{CE} = 10\text{ V};$
 $G_S = 6,7\text{ mA/V}; -jB_S = 5\text{ mA/V}$ F typ. 3,5 dB

y-parameters (common base) at $f = 100\text{ MHz}$

$-I_C = 4\text{ mA}; -V_{CB} = 10\text{ V}$

Input conductance g_{ib} typ. 125 mA/V

Input capacitance $-C_{ib}$ typ. 64 pF

Transfer admittance $|y_{fb}|$ typ. 100 mA/V

Phase angle of transfer admittance φ_{fb} typ. 147°

Output conductance g_{ob} typ. 40 $\mu\text{A/V}$

Output capacitance C_{ob} typ. 1,25 pF

Feedback admittance $|y_{rb}|$ typ. 220 $\mu\text{A/V}$

Phase angle of feedback admittance $-\varphi_{rb}$ typ. 85°

7267064.1

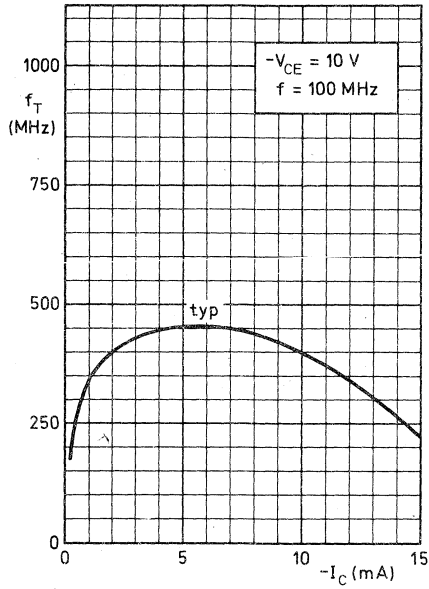

REPRODUCED FROM THE ORIGINAL DATA SHEET

7267061.2

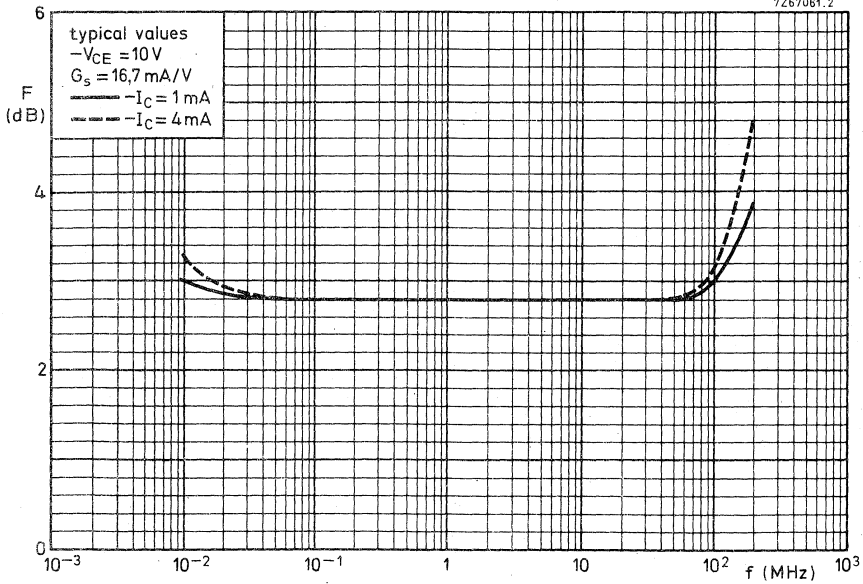

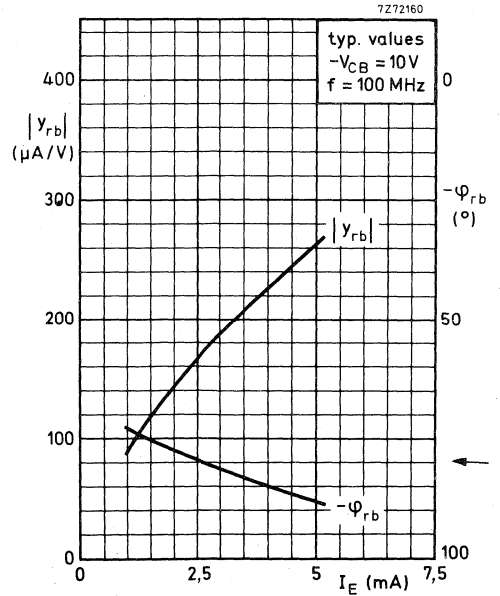
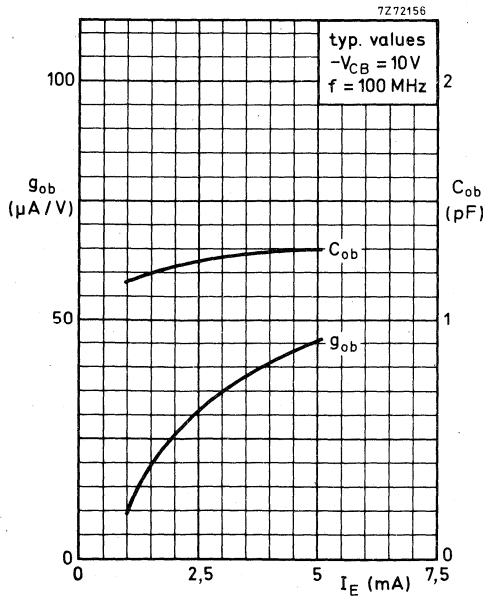
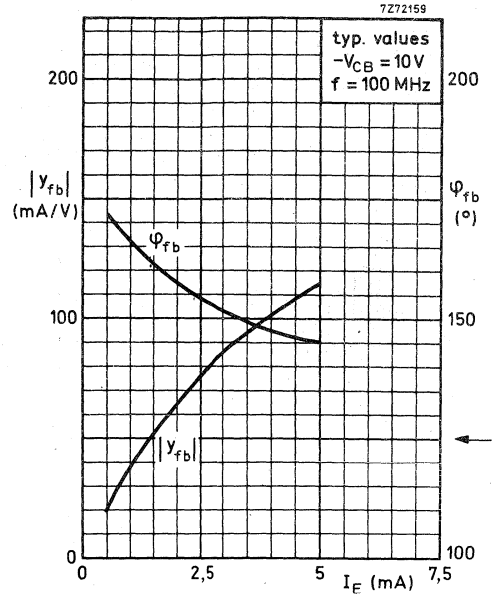
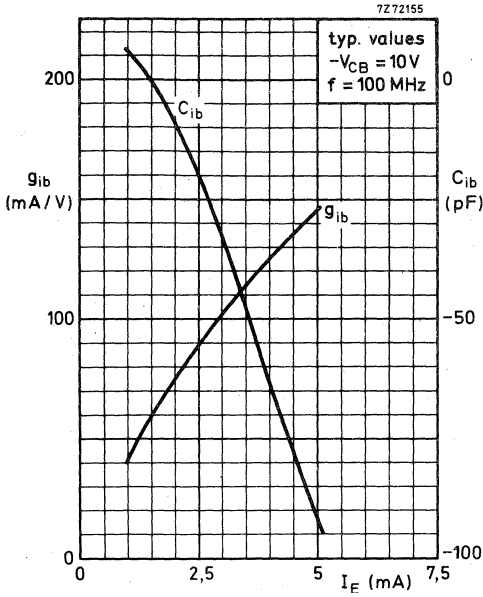

7Z72154

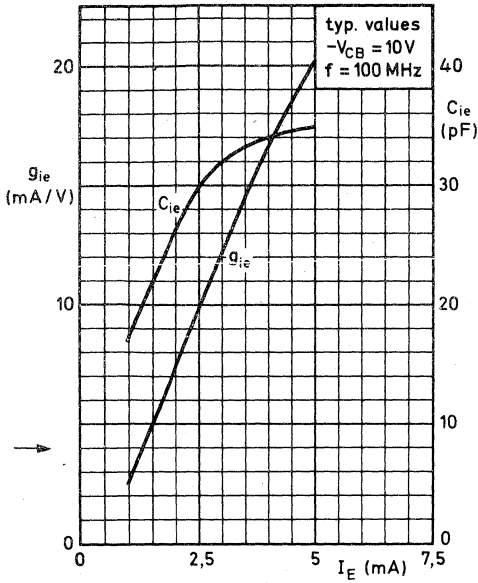

7Z72158

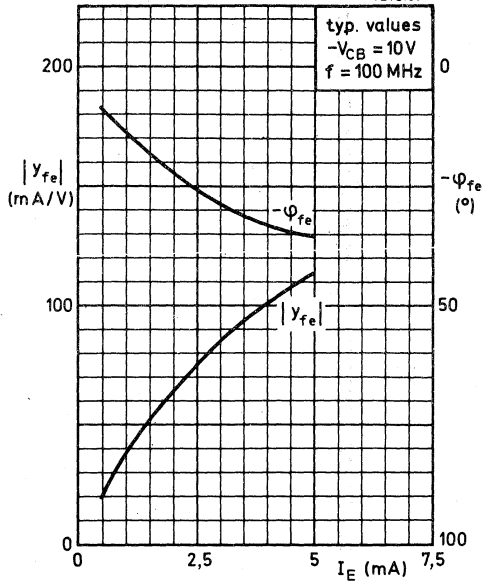

7Z72157

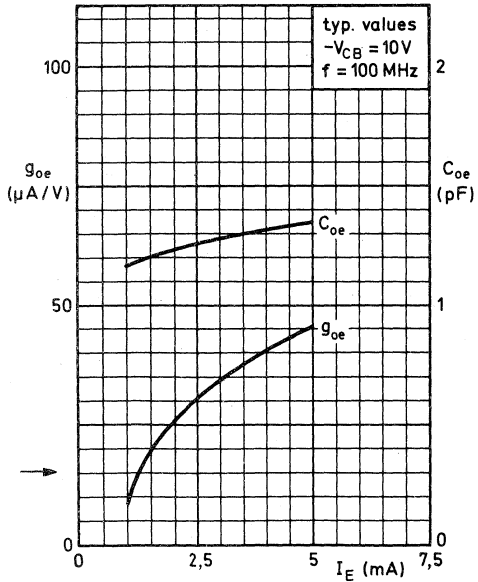

7Z72161

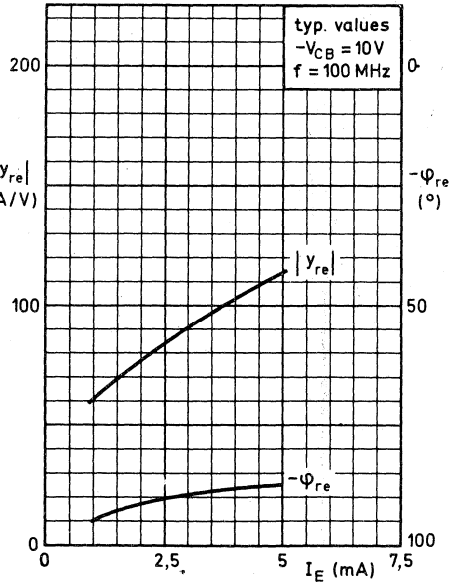

N-P-N SILICON PLANAR TRANSISTORS FOR VIDEO OUTPUT STAGES

N-P-N transistors in a TO-39 metal envelope intended for the video amplifier and the line driver in black-and-white and colour television receivers.

| QUICK REFERENCE DATA | | | | | |
|---|----------------|-------|-------|-------|--------------------|
| | | BF336 | BF337 | BF338 | |
| Collector-base voltage (open emitter) | V_{CBO} max. | 185 | 250 | 300 | V |
| Collector-emitter voltage (open base) | V_{CEO} max. | 180 | 200 | 225 | V |
| Collector current (peak value) | I_{CM} max. | | 200 | | mA |
| Total power dissipation up to $T_{mb} = 140\text{ }^{\circ}\text{C}$ | P_{tot} max. | | 3,0 | | W |
| Junction temperature | T_j max. | | 200 | | $^{\circ}\text{C}$ |
| D.C. current gain at $T_j = 25\text{ }^{\circ}\text{C}$ $I_C = 30\text{ mA}; V_{CE} = 10\text{ V}$ | h_{FE} | > | 20 | | |
| Transition frequency $I_C = 30\text{ mA}; V_{CE} = 20\text{ V}$ | f_T | > | 80 | MHz | |
| Feedback capacitance at $f = 0,5\text{ MHz}$ $I_C = 10\text{ mA}; V_{CE} = 20\text{ V}$ | C_{re} | < | 3,5 | pF | |

MECHANICAL DATA

Dimensions in mm

TO-39

Collector connected to case

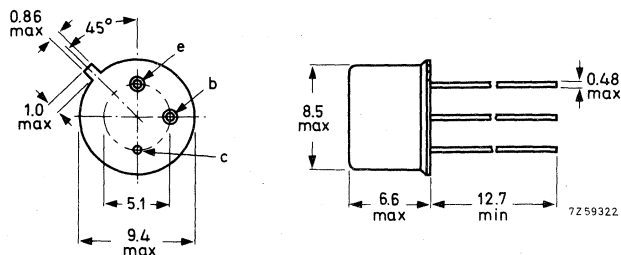

Max. lead diameter is guaranteed only for 12,7 mm

Accessories supplied on request: 56218; 56245

RATINGS Limiting values in accordance with the Absolute Maximum System (IEC 134)

Voltages

| | | BF336 | BF337 | BF338 | |
|--|-----------|----------|-------|-------|---|
| Collector-base voltage (open emitter) | V_{CBO} | max. 185 | 250 | 300 | V |
| Collector-emitter voltage ($R_{BE} \leq 1 \text{ k}\Omega$) $I_C = 1 \text{ mA}$; up to $T_j = 150 \text{ }^\circ\text{C}$ | V_{CER} | max. 185 | 250 | 300 | V |
| Collector-emitter voltage (open base) $I_C = 4 \text{ mA}$ | V_{CEO} | max. 180 | 200 | 225 | V |
| Emitter-base voltage (open collector) $I_E = 0.1 \text{ mA}$ | V_{EBO} | max. 5 | 5 | 5 | V |

Currents

| | | | | |
|--------------------------------|----------|------|-----|----|
| Collector current (d. c.) | I_C | max. | 100 | mA |
| Collector current (peak value) | I_{CM} | max. | 200 | mA |
| Base current (peak value) | I_{BM} | max. | 20 | mA |

Power dissipation

| | | | | |
|--|-----------|------|-----|---|
| Total power dissipation up to $T_{mb} = 140 \text{ }^\circ\text{C}$ | P_{tot} | max. | 3.0 | W |
|--|-----------|------|-----|---|

Temperatures

| | | | |
|----------------------|-----------|-------------|------------------|
| Storage temperature | T_{stg} | -65 to +200 | $^\circ\text{C}$ |
| Junction temperature | T_j | max. 200 | $^\circ\text{C}$ |

THERMAL RESISTANCE

| | | | | |
|--------------------------------|-----------------------|---|-----|--------------------|
| From junction to ambient | $R_{th \text{ j-a}}$ | = | 220 | $^\circ\text{C/W}$ |
| From junction to mounting base | $R_{th \text{ j-mb}}$ | = | 20 | $^\circ\text{C/W}$ |
| From junction to case | $R_{th \text{ j-c}}$ | = | 25 | $^\circ\text{C/W}$ |

CHARACTERISTICS

$T_j = 25\text{ }^\circ\text{C}$ unless otherwise specified

Collector cut-off current at $R_{BE} = 1\text{ k}\Omega$

$V_{CE} = 150\text{ V}$ for BF336
 $V_{CE} = 200\text{ V}$ for BF337
 $V_{CE} = 250\text{ V}$ for BF338

I_{CER} typ. 10 nA
 < 100 μA

Base-emitter voltage

$I_C = 30\text{ mA}; V_{CE} = 10\text{ V}$

V_{BE} typ. 0,7 V
 < 1,2 V

High frequency knee voltage at $T_j = 150\text{ }^\circ\text{C}$

$I_C = 50\text{ mA}$

V_{CEK} typ. 10 V

The high frequency knee voltage of a transistor is that value of the collector-emitter voltage at which the small signal gain, measured in a practical circuit, has dropped to 80% of the gain at $V_{CE} = 50\text{ V}$. A further reduction of the collector-emitter voltage results in a rapid increase of the distortion of the signal.

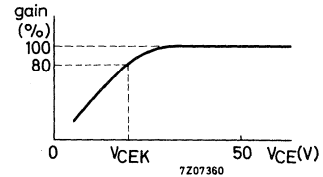
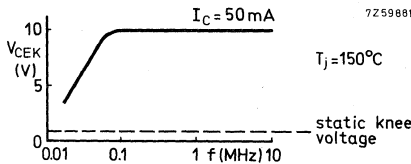

D.C. current gain

$I_C = 30\text{ mA}; V_{CE} = 10\text{ V}$

h_{FE} > 20
 typ. 60

Feedback capacitance at $f = 0.5\text{ MHz}$

$I_C = 10\text{ mA}; V_{CE} = 20\text{ V}$

C_{re} typ. 3,0 pF
 < 3,5 pF

Feedback time constant at $f = 10\text{ MHz}$

$-I_E = 30\text{ mA}; V_{CB} = 20\text{ V}$

$r_{bb} \cdot C_{b'c}$ typ. 30 ps
 < 100 ps

Transition frequency at $f = 100\text{ MHz}$

$I_C = 30\text{ mA}; V_{CE} = 20\text{ V}$

f_T > 80 MHz
 typ. 130 MHz

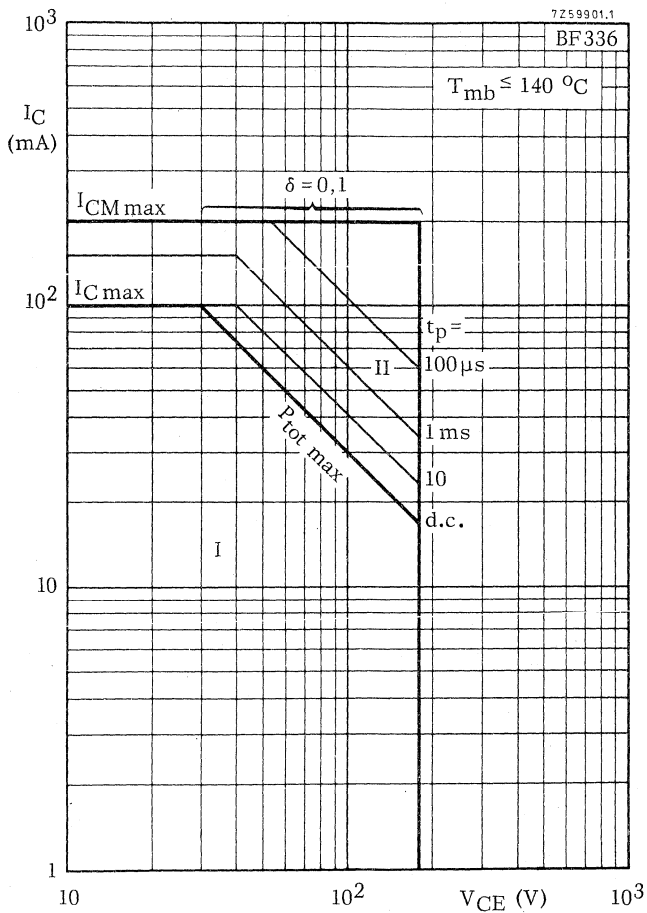

Safe Operating Area with the transistor forward biased

I Region of permissible d. c. operation

II Permissible extension for repetitive pulse operation

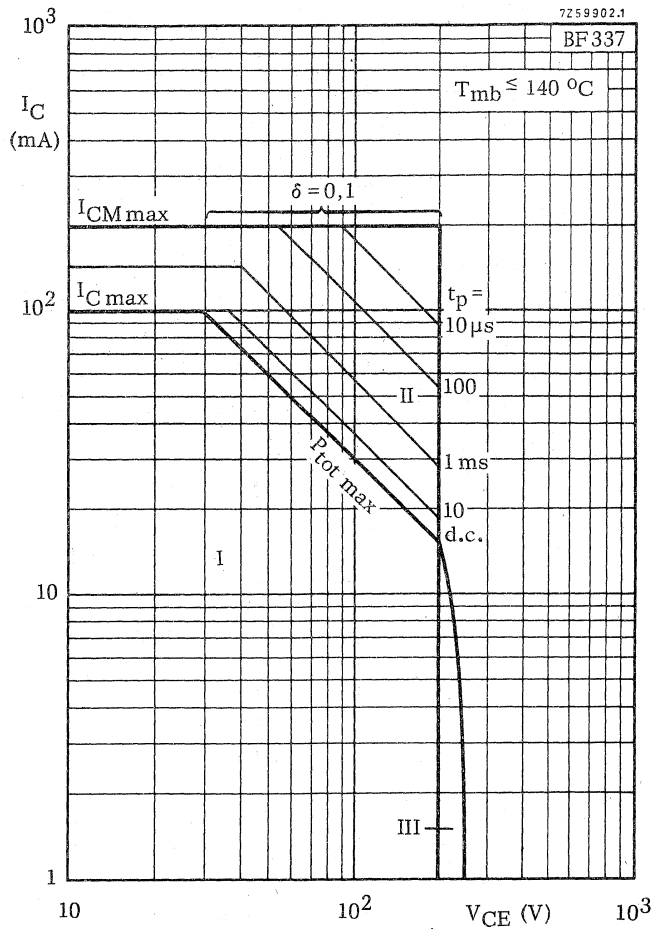

Safe Operating Area with the transistor forward biased

- I Region of permissible d.c. operation
- II Permissible extension for repetitive pulse operation
- III Repetitive pulse operation in this region is allowable, provided $R_{BE} \leq 1\text{ k}\Omega$

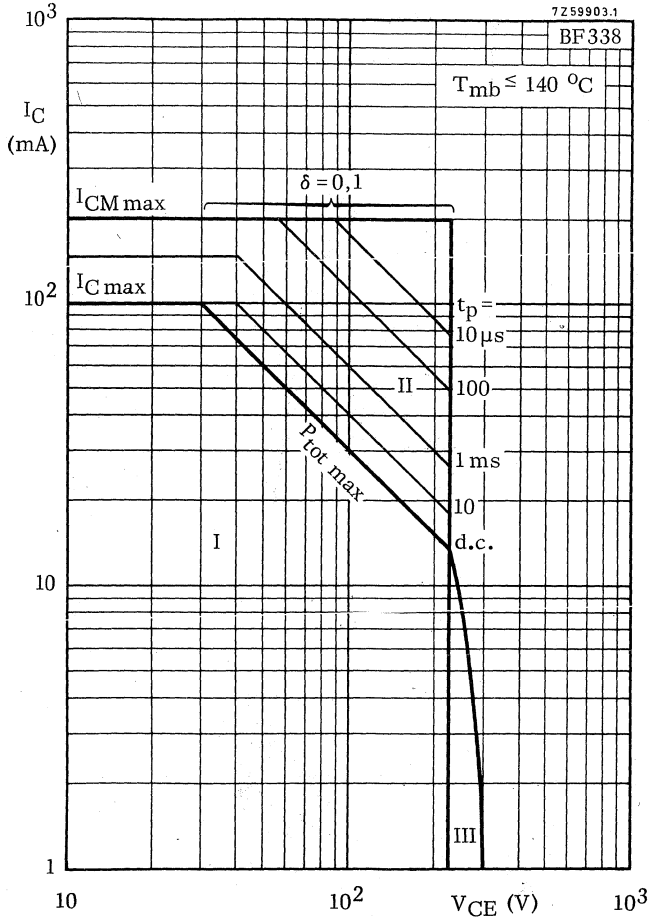

Safe Operating Area with the transistor forward biased

- I Region of permissible d.c. operation
- II Permissible extension for repetitive pulse operation
- III Repetitive pulse operation in this region is allowable, provided $R_{BE} \leq 1 \text{ k}\Omega$

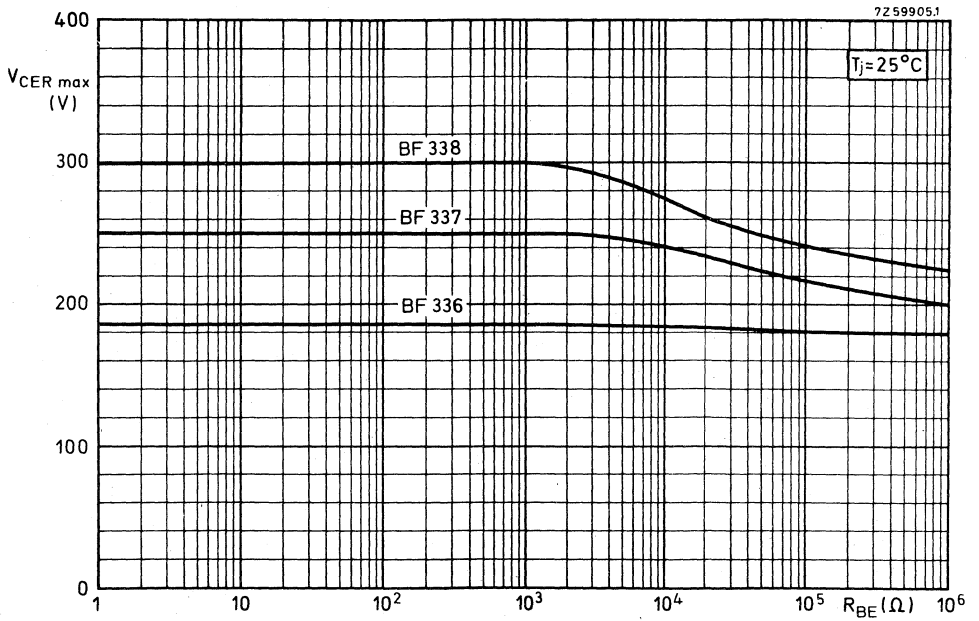
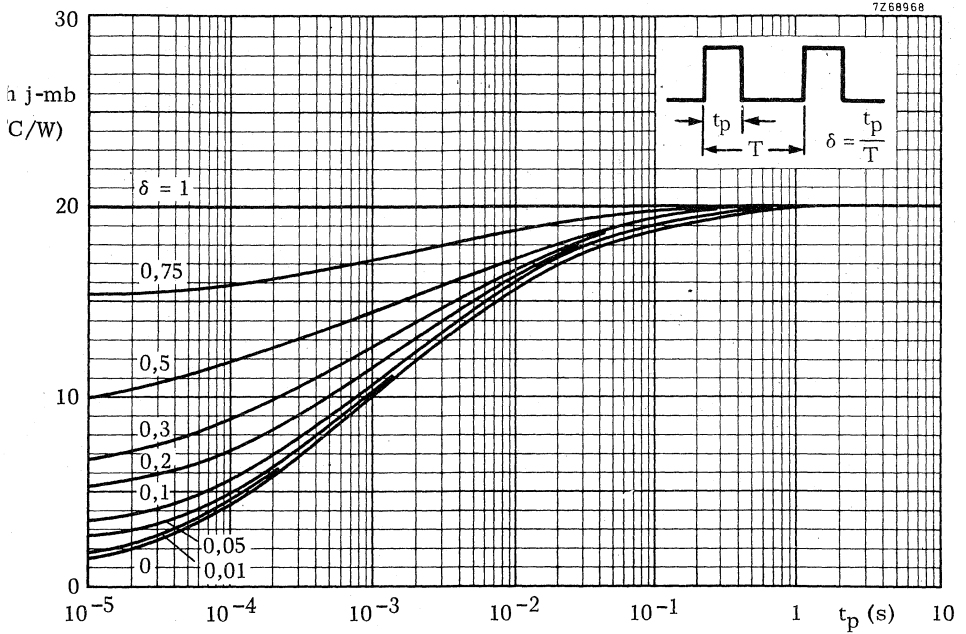

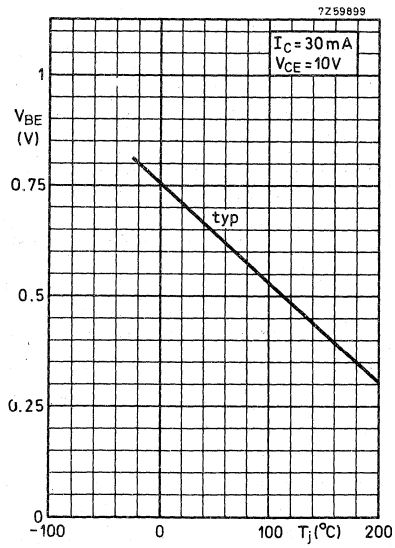
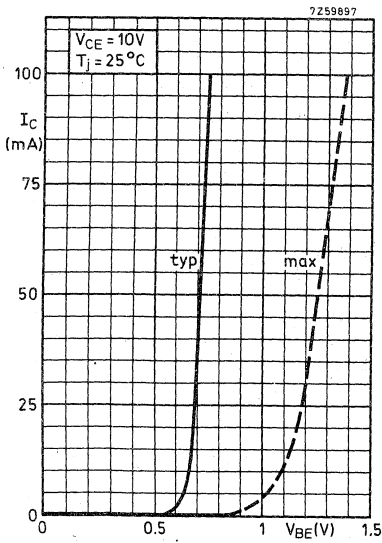
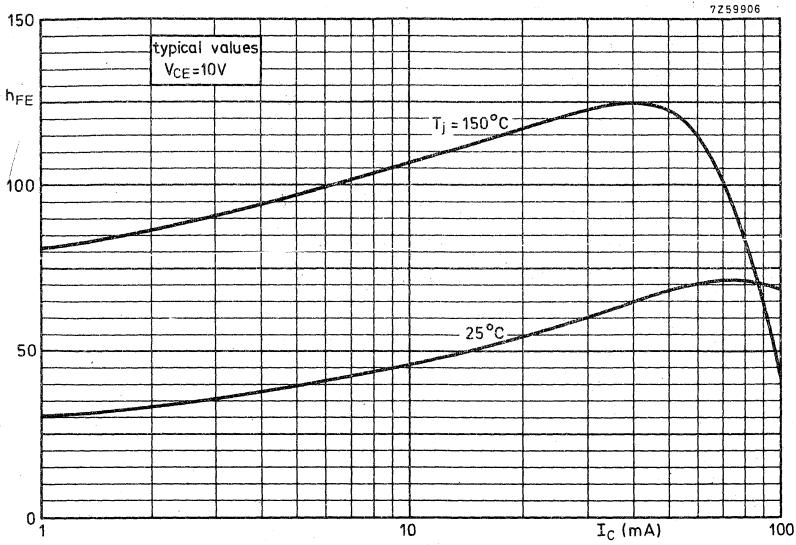

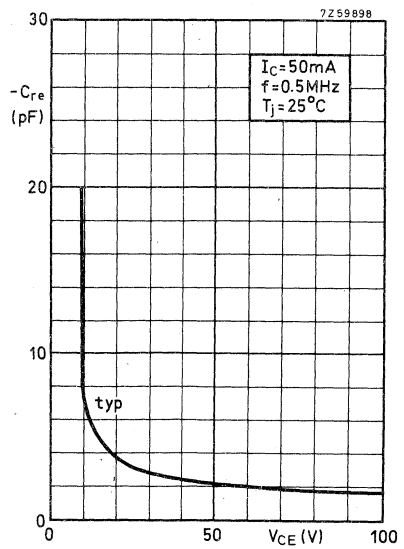
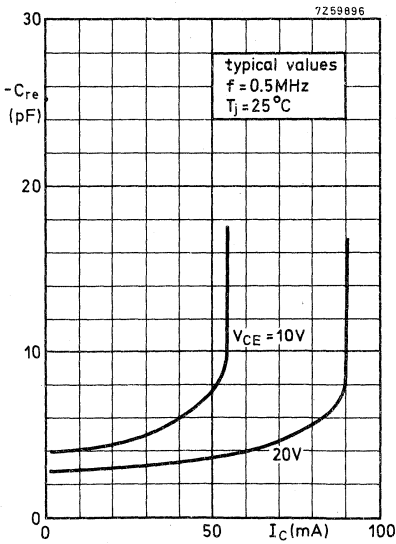
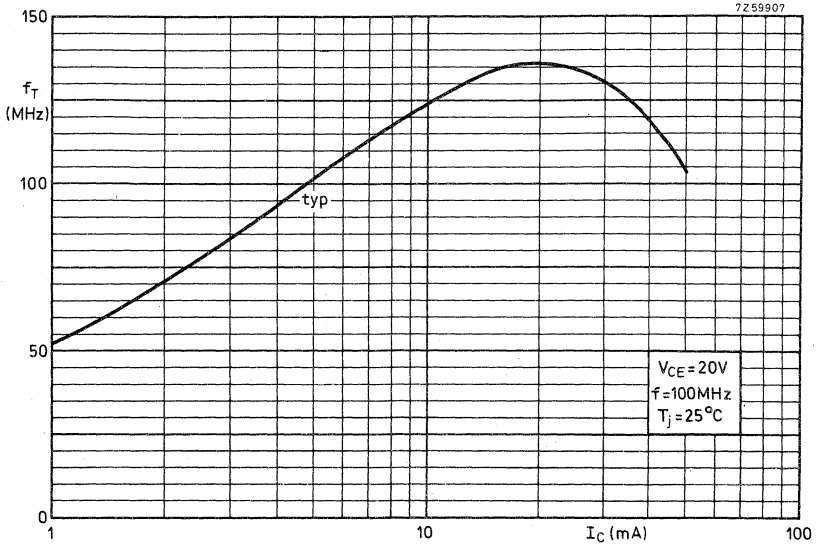

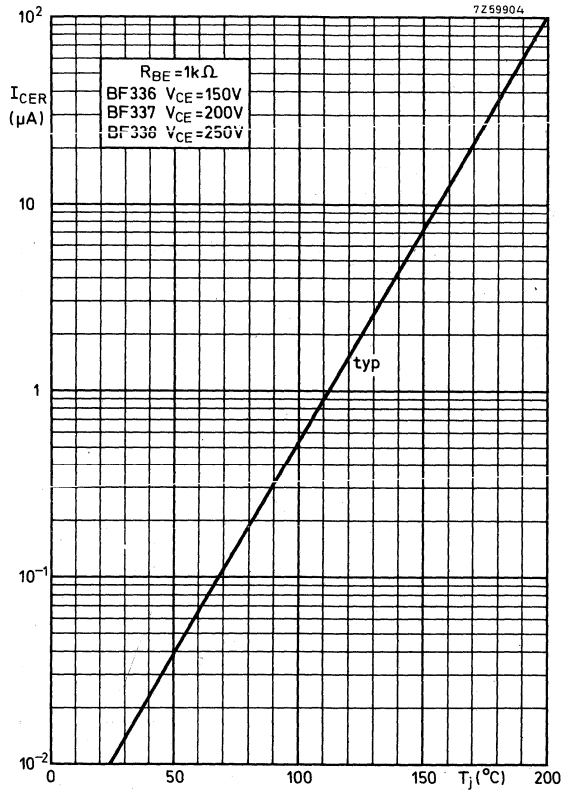

U.H.F. SILICON PLANAR TRANSISTORS

High gain n-p-n transistors in plastic T-package. The BF362 is intended for use in the r. f. stage of television tuners and the BF363 is an oscillator-mixer. The combination of low self-capacitance and low lead inductance due to the T-package makes these devices especially suitable for use in television tuners with diode tuning.

| QUICK REFERENCE DATA | | | | |
|--|--------------|-------|------------|-----|
| Collector-base voltage (open emitter) | V_{CBO} | max. | 30 | V |
| Collector-emitter voltage (open base) | V_{CEO} | max. | 20 | V |
| Collector current (d. c.) | I_C | max. | 20 | mA |
| Total power dissipation up to $T_{amb} = 55\text{ }^{\circ}\text{C}$ | P_{tot} | max. | 120 | mW |
| Transition frequency | | | | |
| $I_C = 3\text{ mA}; V_{CE} = 10\text{ V}$ | <u>BF362</u> | f_T | typ. 800 | MHz |
| | <u>BF363</u> | f_T | 600 to 820 | MHz |
| Transducer gain at $f = 900\text{ MHz}$ | | | | |
| $-I_E = 3\text{ mA}; V_{CC} = 12\text{ V}$ | G_{tr} | > | 11 | dB |
| Noise figure at $f = 800\text{ MHz}$ | | | | |
| $-I_E = 3\text{ mA}; V_{CC} = 12\text{ V}$ | F | typ. | 5 | dB |
| Feedback capacitance at $f = 10,7\text{ MHz}$ | | | | |
| $I_C = 1\text{ mA}; V_{CE} = 10\text{ V}$ | C_{re} | typ. | 0,25 | pF |

MECHANICAL DATA

Dimensions in mm

SOT 37

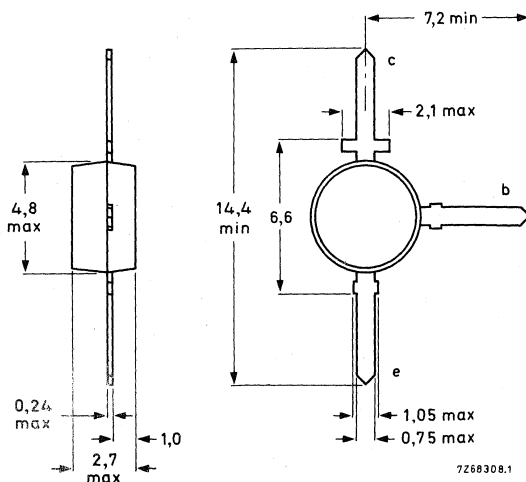

RATINGS Limiting values in accordance with the Absolute Maximum System (IEC 134)

Voltages

| | | | | |
|---------------------------------------|-----------|------|----|---|
| Collector-base voltage (open emitter) | V_{CBO} | max. | 30 | V |
| Collector-emitter voltage (open base) | V_{CEO} | max. | 20 | V |
| Emitter-base voltage (open collector) | V_{EBO} | max. | 3 | V |

Currents

| | | | | |
|--------------------------------|----------|------|----|----|
| Collector current (d. c.) | I_C | max. | 20 | mA |
| Collector current (peak value) | I_{CM} | max. | 20 | mA |

Power dissipation

| | | | | |
|--|-----------|------|-----|----|
| Total power dissipation up to $T_{amb} = 55^\circ\text{C}$ | P_{tot} | max. | 120 | mW |
|--|-----------|------|-----|----|

Temperature

| | | | | |
|----------------------|-----------|------|-----------------------------|------------------|
| Junction temperature | T_j | max. | 125 | $^\circ\text{C}$ |
| Storage temperature | T_{stg} | | -55 $^\circ\text{C}$ to 125 | $^\circ\text{C}$ |

THERMAL RESISTANCE

| | | | | |
|--------------------------------------|---------------|---|------|----------------------------|
| From junction to ambient in free air | $R_{th\ j-a}$ | = | 0,58 | $^\circ\text{C}/\text{mW}$ |
|--------------------------------------|---------------|---|------|----------------------------|

CHARACTERISTICS

$T_{amb} = 25^\circ\text{C}$ unless otherwise specified

Base current

| | | | | |
|--|-------|------|-----|---------------|
| $-I_E = 3\text{ mA}; V_{CB} = 10\text{ V}$ | I_B | typ. | 60 | μA |
| | | < | 150 | μA |
| $-I_E = 12\text{ mA}; V_{CB} = 7\text{ V}$ | I_B | typ. | 0,3 | mA |
| | | < | 1,0 | mA |

Emitter-base voltage

| | | | | |
|--|-----------|------|------|---|
| $-I_E = 3\text{ mA}; V_{CB} = 10\text{ V}$ | $-V_{EB}$ | typ. | 0,75 | V |
| $-I_E = 12\text{ mA}; V_{CB} = 7\text{ V}$ | $-V_{EB}$ | typ. | 0,80 | V |

Transition frequency at $f = 100\text{ MHz}$

| | | | | | |
|---|--------------|-------|------|------------|-----|
| $I_C = 3\text{ mA}; V_{CE} = 10\text{ V}$ | <u>BF362</u> | f_T | typ. | 800 | MHz |
| | <u>BF363</u> | f_T | | 600 to 820 | MHz |

Feedback capacitance at $f = 10,7\text{ MHz}$

| | | | | |
|---|----------|------|------|----|
| $I_C = 1\text{ mA}; V_{CE} = 10\text{ V}$ | C_{re} | typ. | 0,25 | pF |
|---|----------|------|------|----|

CHARACTERISTICS (continued)

$T_{amb} = 25^{\circ}C$ unless otherwise specified

Noise figure

$-I_E = 3 \text{ mA}; V_{CC} = 12 \text{ V}; f = 800 \text{ MHz}$

$G_S = 27 \text{ mA/V}; B_S = 9 \text{ mA/V}; R_C = 390 \Omega$ F typ. 5,0 dB

$-I_E = 3 \text{ mA}; V_{CC} = 12 \text{ V}; f = 500 \text{ MHz}$

$G_S = 32 \text{ mA/V}; -B_S = 11 \text{ mA/V}; R_C = 390 \Omega$ F typ. 4,5 dB

Transducer gain at $f = 900 \text{ MHz}$

$-I_E = 3 \text{ mA}; V_{CC} = 12 \text{ V}$

$G_S = 20 \text{ mA/V}; B_S = 0$

$G_L = 2 \text{ mA/V}; B_L \text{ tuned}; R_C = 390 \Omega$ G_{tr} > 11 dB
typ. 12 dB

y-parameters (common base)

$-I_E = 3 \text{ mA}; V_{CB} = 10 \text{ V}$

| | f | = | 500 | 900 | MHz |
|------------------------------------|----------------|------|---------------|---------------|-----------------|
| Input conductance | g_{ib} | typ. | 18 | 8 | mA/V |
| Input susceptance | $-b_{ib}$ | typ. | 34 | 30 | mA/V |
| Feedback admittance | $ y_{rb} $ | typ. | 500 | 900 | $\mu\text{A/V}$ |
| Phase angle of feedback admittance | φ_{rb} | typ. | 270° | 250° | |
| Transfer admittance | $ y_{fb} $ | typ. | 45 | 25 | mA/V |
| Phase angle of transfer admittance | φ_{fb} | typ. | 80° | 40° | |
| Output conductance | g_{ob} | typ. | 0,6 | 1,8 | $\mu\text{A/V}$ |
| Output capacitance | C_{ob} | typ. | 0,5 | 0,6 | pF |

7Z67281

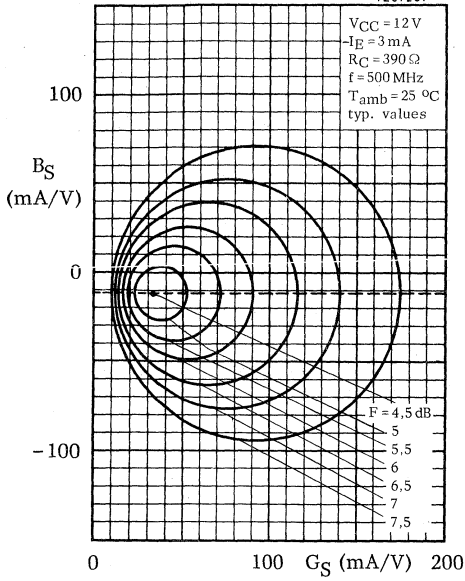

7Z67280

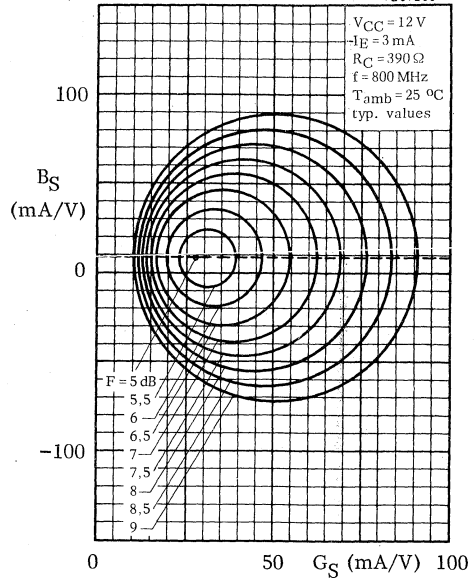

7Z67286

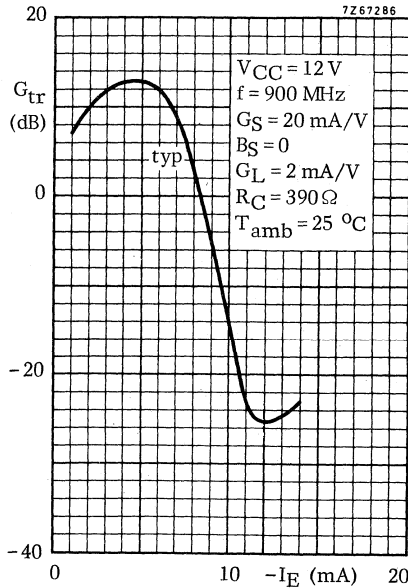

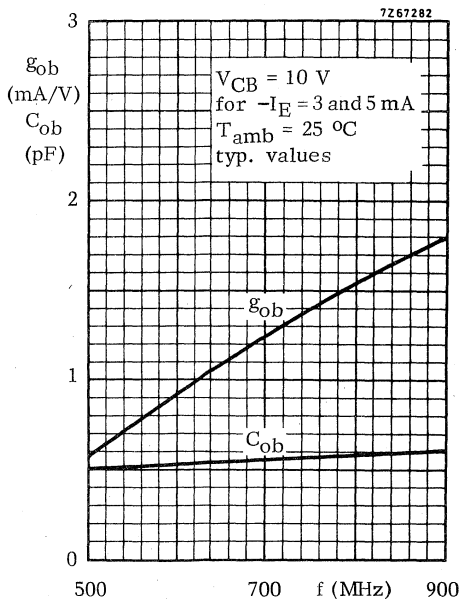
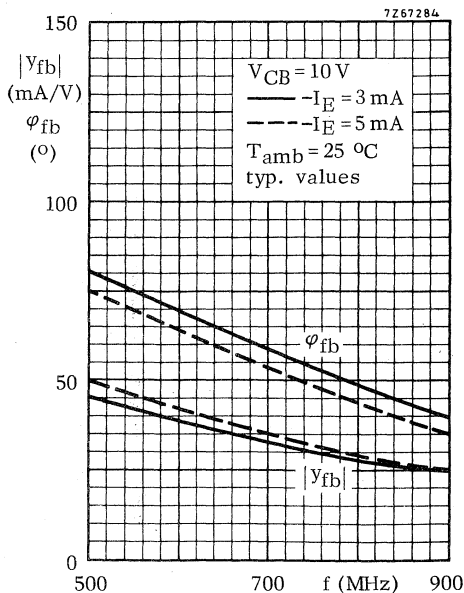
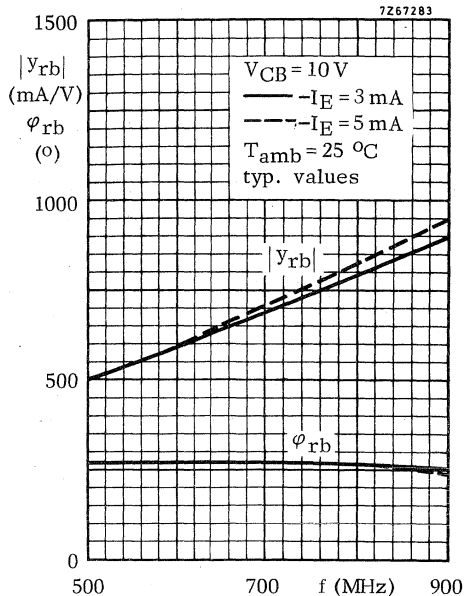
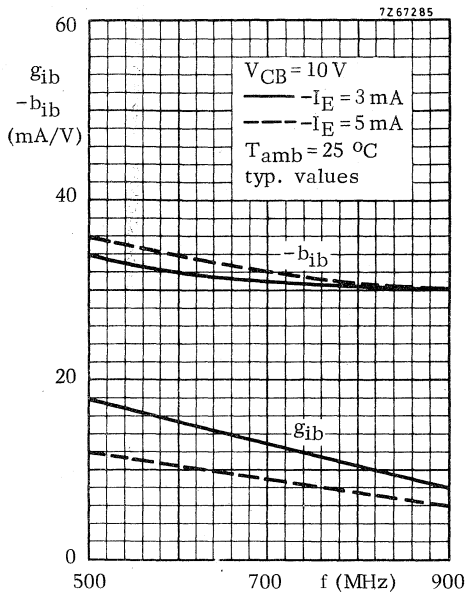

SILICON EPITAXIAL TRANSISTOR FOR VIDEO OUTPUT STAGES

N-P-N transistor in plastic TO-92 variant intended for class-B video output stages in colour television receivers. P-N-P complement is BF423.

| QUICK REFERENCE DATA | | | |
|--|-----------|------|------------------------|
| Collector-base voltage (open emitter) | V_{CBO} | max. | 250 V |
| Collector-emitter voltage (open base) | V_{CEO} | max. | 250 V |
| Collector current (peak value) | I_{CM} | max. | 100 mA |
| Total power dissipation up to $T_{amb} = 25\text{ }^{\circ}\text{C}$ | P_{tot} | max. | 830 mW |
| Junction temperature | T_j | max. | 150 $^{\circ}\text{C}$ |
| D. C. current gain at $T_j = 25\text{ }^{\circ}\text{C}$ $I_C = 25\text{ mA}; V_{CE} = 20\text{ V}$ | h_{FE} | > | 50 |
| Transition frequency $-I_E = 10\text{ mA}; V_{CB} = 10\text{ V}$ | f_T | > | 60 MHz |
| Feedback capacitance at $f = 0,5\text{ MHz}$ $I_E = 0; V_{CB} = 30\text{ V}$ | C_{re} | < | 1,6 pF |

MECHANICAL DATA

Dimensions in mm

TO -92 variant

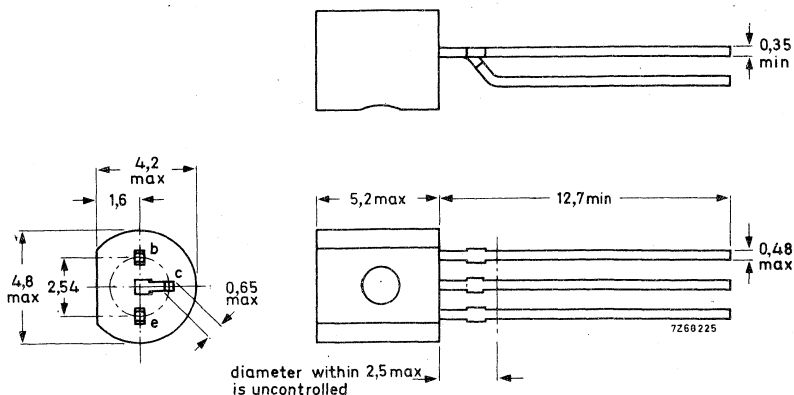

Accessory: 56356 (cooling clip).

RATINGS Limiting values in accordance with the Absolute Maximum System (IEC 134)Voltages

| | | | | |
|---------------------------------------|-----------|------|-----|---|
| Collector-base voltage (open emitter) | V_{CBO} | max. | 250 | V |
| Collector-emitter voltage (open base) | V_{CEO} | max. | 250 | V |
| Emitter-base voltage (open collector) | V_{EBO} | max. | 5 | V |

Currents

| | | | | |
|--------------------------------|----------|------|-----|----|
| Collector current (d. c.) | I_C | max. | 20 | mA |
| Collector current (peak value) | I_{CM} | max. | 100 | mA |

Power dissipation

| | | | | |
|--|-----------|------|-----|----|
| Total power dissipation up to $T_{amb} = 25\text{ }^{\circ}\text{C}$ ¹⁾ | P_{tot} | max. | 830 | mW |
|--|-----------|------|-----|----|

Temperatures

| | | | |
|----------------------|-----------|-------------|--------------------|
| Storage temperature | T_{stg} | -65 to +150 | $^{\circ}\text{C}$ |
| Junction temperature | T_j | max. 150 | $^{\circ}\text{C}$ |

THERMAL RESISTANCE

| | | | | |
|--|---------------|---|------|------------------------------|
| From junction to ambient ¹⁾ | $R_{th\ j-a}$ | = | 0,15 | $^{\circ}\text{C}/\text{mW}$ |
|--|---------------|---|------|------------------------------|

¹⁾ Transistor mounted on printed-circuit board, max. lead length 4 mm, mounting pad for collector lead min. 10 mm x 10 mm.

CHARACTERISTICS

$T_j = 25\text{ }^\circ\text{C}$ unless otherwise specified

Collector cut-off currents

$I_E = 0; V_{CE} = 200\text{ V}$

$I_{CBO} < 10\text{ nA}$

$R_{BE} = 10\text{ k}\Omega; V_{CE} = 200\text{ V}; T_j = 150\text{ }^\circ\text{C}$

$I_{CER} < 10\text{ }\mu\text{A}$

Emitter cut-off current

$I_C = 0; V_{EB} = 5\text{ V}$

$I_{EBO} < 10\text{ }\mu\text{A}$

D.C. current gain

$I_C = 25\text{ mA}; V_{CE} = 20\text{ V}$

$h_{FE} > 50$

High-frequency knee voltage at $T_j = 150\text{ }^\circ\text{C}$

$I_C = 25\text{ mA}$

$V_{CEK} \text{ typ. } 20\text{ V}$

The high-frequency knee voltage of a transistor is that value of the collector-emitter voltage at which the small-signal gain, measured in a practical circuit, has dropped to 80% of the gain at $V_{CE} = 50\text{ V}$. A further reduction of the collector-emitter voltage results in a rapid increase of the distortion of the signal.

Transition frequency

$-I_E = 10\text{ mA}; V_{CB} = 10\text{ V}$

$f_T > 60\text{ MHz}$

Feedback capacitance at $f = 0,5\text{ MHz}$

$I_E = 0; V_{CB} = 30\text{ V}$

$C_{re} < 1,6\text{ pF}$

Feedback time constant at $f = 10,7\text{ MHz}$

$-I_E = 30\text{ mA}; V_{CB} = 20\text{ V}$

$r_{bb'} C_{b'c} < 70\text{ ps } 1)$

1) $r_{bb'} C_{b'c} = \frac{|h_{rb}|}{\omega}$

SILICON EPITAXIAL TRANSISTOR FOR VIDEO OUTPUT STAGES

P-N-P transistor in a plastic TO-92 variant intended for class-B video output stages in colour television receivers. N-P-N complement is BF422.

| QUICK REFERENCE DATA | | | |
|--|------------|------|------------------------|
| Collector-base voltage (open emitter) | $-V_{CBO}$ | max. | 250 V |
| Collector-emitter voltage (open base) | $-V_{CEO}$ | max. | 250 V |
| Collector current (peak value) | $-I_{CM}$ | max. | 100 mA |
| Total power dissipation up to $T_{amb} = 25\text{ }^{\circ}\text{C}$ | P_{tot} | max. | 830 mW |
| Junction temperature | T_j | max. | 150 $^{\circ}\text{C}$ |
| D. C. current gain at $T_j = 25\text{ }^{\circ}\text{C}$ $-I_C = 25\text{ mA}; -V_{CE} = 20\text{ V}$ | h_{FE} | > | 50 |
| Transition frequency $I_E = 10\text{ mA}; -V_{CB} = 10\text{ V}$ | f_T | > | 60 MHz |
| Feedback capacitance at $f = 0,5\text{ MHz}$ $I_E = 0; -V_{CB} = 30\text{ V}$ | C_{re} | < | 1,6 pF |

MECHANICAL DATA

Dimensions in mm

TO-92 variant

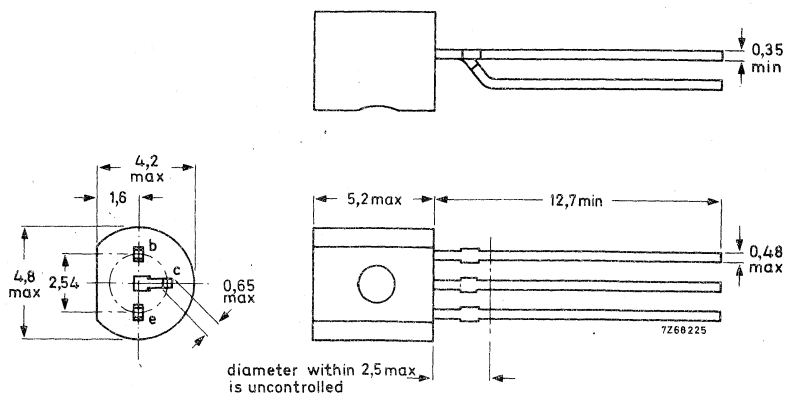

Accessory: 56356 (cooling clip).

RATINGS Limiting values in accordance with the Absolute Maximum System (IEC 134)

Voltages

| | | | | |
|---------------------------------------|------------|------|-----|---|
| Collector-base voltage (open emitter) | $-V_{CBO}$ | max. | 250 | V |
| Collector-emitter voltage (open base) | $-V_{CEO}$ | max. | 250 | V |
| Emitter-base voltage (open collector) | $-V_{EBO}$ | max. | 5 | V |

Currents

| | | | | |
|--------------------------------|-----------|------|-----|----|
| Collector current (d.c.) | $-I_C$ | max. | 20 | mA |
| Collector current (peak value) | $-I_{CM}$ | max. | 100 | mA |

Power dissipation

| | | | | |
|--|-----------|------|-----|----|
| Total power dissipation up to $T_{amb} = 25\text{ }^{\circ}\text{C}$ ¹⁾ | P_{tot} | max. | 830 | mW |
|--|-----------|------|-----|----|

Temperatures

| | | | |
|----------------------|-----------|-------------|--------------------|
| Storage temperature | T_{stg} | -65 to +150 | $^{\circ}\text{C}$ |
| Junction temperature | T_j | max. 150 | $^{\circ}\text{C}$ |

THERMAL RESISTANCE

| | | | | |
|--|---------------|---|------|------------------------------|
| From junction to ambient ¹⁾ | $R_{th\ j-a}$ | = | 0,15 | $^{\circ}\text{C}/\text{mW}$ |
|--|---------------|---|------|------------------------------|

¹⁾ Transistor mounted on printed-circuit board, max. lead length 4 mm, mounting pad for collector lead min. 10 mm x 10 mm.

CHARACTERISTICS

$T_j = 25\text{ }^\circ\text{C}$ unless otherwise specified

Collector cut-off currents

| | | | | |
|---|------------|---|----|---------------|
| $I_E = 0; -V_{CB} = 200\text{ V}$ | $-I_{CBO}$ | < | 10 | nA |
| $R_{BE} = 10\text{ k}\Omega; -V_{CE} = 200\text{ V}; T_j = 150\text{ }^\circ\text{C}$ | $-I_{CER}$ | < | 10 | μA |

Emitter cut-off current

| | | | | |
|---------------------------------|------------|---|----|---------------|
| $I_C = 0; -V_{EB} = 5\text{ V}$ | $-I_{EBO}$ | < | 10 | μA |
|---------------------------------|------------|---|----|---------------|

D. C. current gain

| | | | | |
|--|----------|---|----|--|
| $-I_C = 25\text{ mA}; -V_{CE} = 20\text{ V}$ | h_{FE} | > | 50 | |
|--|----------|---|----|--|

High-frequency knee voltage at $T_j = 150\text{ }^\circ\text{C}$

| | | | | |
|-----------------------|------------|------|----|---|
| $-I_C = 25\text{ mA}$ | $-V_{CEK}$ | typ. | 20 | V |
|-----------------------|------------|------|----|---|

The high-frequency knee voltage of a transistor is that value of the collector-emitter voltage at which the small-signal gain, measured in a practical circuit, has dropped to 80% of the gain at $-V_{CE} = 50\text{ V}$. A further reduction of the collector-emitter voltage results in a rapid increase of the distortion of the signal.

Transition frequency

| | | | | |
|---|-------|---|----|-----|
| $I_E = 10\text{ mA}; -V_{CB} = 10\text{ V}$ | f_T | > | 60 | MHz |
|---|-------|---|----|-----|

Feedback capacitance at $f = 0,5\text{ MHz}$

| | | | | |
|----------------------------------|----------|---|-----|----|
| $I_E = 0; -V_{CB} = 30\text{ V}$ | C_{re} | < | 1,6 | pF |
|----------------------------------|----------|---|-----|----|

Feedback time constant at $f = 10,7\text{ MHz}$

| | | | | |
|---|-------------------|---|----|------------------|
| $I_E = 30\text{ mA}; -V_{CB} = 20\text{ V}$ | $r_{bb'} C_{b'c}$ | < | 70 | ps ¹⁾ |
|---|-------------------|---|----|------------------|

1) $r_{bb'} C_{b'c} = \frac{|h_{rb}|}{\omega}$

H.F. SILICON PLANAR EPITAXIAL TRANSISTORS

P-N-P transistors in a plastic envelope intended for h.f. and i.f. applications in radio receivers, especially for mixer stages in a.m. receivers and i.f. stages in a.m./f.m. receivers with negative earth.

| QUICK REFERENCE DATA | | | | |
|--|---------------|--------|----------|------------------|
| Collector-base voltage (open emitter) | $-V_{CBO}$ | max. | 40 | V |
| Collector-emitter voltage (open base) | $-V_{CEO}$ | max. | 40 | V |
| Collector current (d. c.) | $-I_C$ | max. | 25 | mA |
| Total power dissipation up to $T_{amb} = 45\text{ }^\circ\text{C}$ | P_{tot} | max. | 250 | mW |
| Junction temperature | T_j | max. | 150 | $^\circ\text{C}$ |
| Base current | | | | |
| $-I_C = 1\text{ mA}; -V_{CE} = 10\text{ V}$ | <u>BF450:</u> | $-I_B$ | 5 to 16 | μA |
| | <u>BF451:</u> | $-I_B$ | 11 to 33 | μA |
| Transition frequency | | | | |
| $-I_C = 1\text{ mA}; -V_{CE} = 10\text{ V}$ | f_T | typ. | 325 | MHz |
| Noise figure at $f = 100\text{ kHz}$ | | | | |
| $-I_C = 1\text{ mA}; -V_{CE} = 10\text{ V}; R_S = 300\text{ }\Omega$ | F | typ. | 2 | dB |

MECHANICAL DATA

Dimensions in mm

TO-92 variant

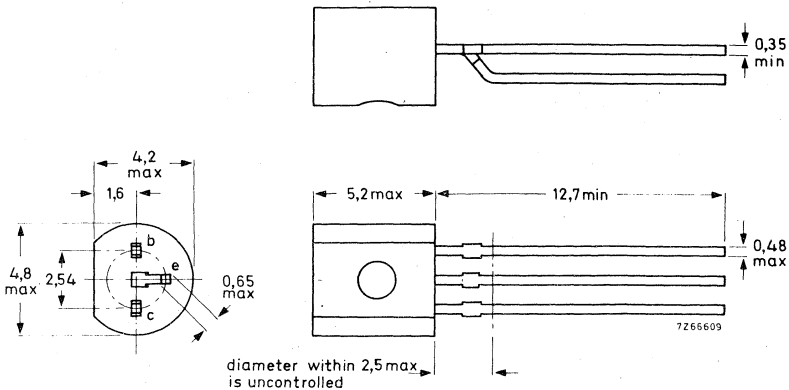

BF450
BF451

RATINGS Limiting values in accordance with the Absolute Maximum System (IEC134)

Voltages

| | | | | |
|---------------------------------------|------------|------|----|---|
| Collector-base voltage (open emitter) | $-V_{CBO}$ | max. | 40 | V |
| Collector-emitter voltage (open base) | $-V_{CEO}$ | max. | 40 | V |
| Emitter-base voltage (open collector) | $-V_{EBO}$ | max. | 4 | V |

Current

| | | | | |
|----------------------------|--------|------|----|----|
| Collector current (d. c.) | $-I_C$ | max. | 25 | mA |
|----------------------------|--------|------|----|----|

Power dissipation

| | | | | |
|--|-----------|------|-----|----|
| Total power dissipation up to $T_{amb} = 45^\circ\text{C}$ | P_{tot} | max. | 250 | mW |
|--|-----------|------|-----|----|

Temperatures

| | | | | |
|----------------------|-----------|------|-------------|------------------|
| Storage temperature | T_{stg} | | -55 to +150 | $^\circ\text{C}$ |
| Junction temperature | T_j | max. | 150 | $^\circ\text{C}$ |

THERMAL RESISTANCE

| | | | | |
|--------------------------------------|---------------|---|------|----------------------------|
| From junction to ambient in free air | $R_{th\ j-a}$ | = | 0.42 | $^\circ\text{C}/\text{mW}$ |
|--------------------------------------|---------------|---|------|----------------------------|

CHARACTERISTICS

$T_j = 25^\circ\text{C}$

Collector cut-off current

| | | | | |
|----------------------------------|------------|---|----|----|
| $I_E = 0; -V_{CB} = 30\text{ V}$ | $-I_{CBO}$ | < | 50 | nA |
|----------------------------------|------------|---|----|----|

| | | | | |
|----------------------------------|------------|---|----|---------------|
| $I_E = 0; -V_{CB} = 40\text{ V}$ | $-I_{CBO}$ | < | 10 | μA |
|----------------------------------|------------|---|----|---------------|

Emitter cut-off current

| | | | | |
|---------------------------------|------------|---|----|---------------|
| $I_C = 0; -V_{EB} = 4\text{ V}$ | $-I_{EBO}$ | < | 10 | μA |
|---------------------------------|------------|---|----|---------------|

Base current

| | | | | | |
|---|---------------|--------|---|----------|---------------|
| → $-I_C = 1\text{ mA}; -V_{CE} = 10\text{ V}$ | <u>BF450:</u> | $-I_B$ | < | 5 to 16 | μA |
| | <u>BF451:</u> | $-I_B$ | < | 11 to 33 | μA |

Base-emitter voltage

| | | | | |
|---|-----------|------|-----|----|
| $-I_C = 1\text{ mA}; -V_{CE} = 10\text{ V}$ | $-V_{BE}$ | typ. | 700 | mV |
|---|-----------|------|-----|----|

CHARACTERISTICS (continued)

$T_j = 25\text{ }^\circ\text{C}$

Transition frequency at $f = 100\text{ MHz}$

$-I_C = 1\text{ mA}; -V_{CE} = 10\text{ V}$ f_T typ. 325 MHz

Feedback capacitance at $f = 1\text{ MHz}$

$-I_C = 1\text{ mA}; -V_{CE} = 10\text{ V}$ C_{re} typ. 0,35 pF

Noise figure at $f = 100\text{ kHz}$

$-I_C = 1\text{ mA}; -V_{CE} = 10\text{ V}; R_S = 300\ \Omega$ F typ. 2 dB

y-parameters (common emitter)

$-I_C = 1\text{ mA}; -V_{CE} = 10\text{ V}$

| | f | = | BF450 | | BF451 | | MHz |
|------------------------------------|----------------|------|-------------|-------------|-------------|-------------|-----------------|
| | | | 0,45 | 10,7 | 0,45 | 10,7 | |
| Input conductance | g_{ie} | typ. | 0,3 | 0,4 | 0,7 | 0,8 | mA/V |
| Input capacitance | C_{ie} | typ. | 20 | 13 | 30 | 20 | pF |
| Transfer admittance | $ y_{fe} $ | typ. | 37 | 37 | 37 | 37 | mA/V |
| Phase angle of transfer admittance | φ_{fe} | typ. | 0° | 0° | 0° | 0° | |
| Output conductance | g_{oe} | typ. | 8 | 10 | 8 | 10 | $\mu\text{A/V}$ |
| Output capacitance | C_{oe} | typ. | 1 | 1 | 1 | 1 | pF |
| Feedback admittance | $ y_{re} $ | typ. | 1 | 24 | 1 | 24 | $\mu\text{A/V}$ |
| Phase angle of feedback admittance | φ_{re} | typ. | 270° | 270° | 270° | 270° | |

BF450
BF451

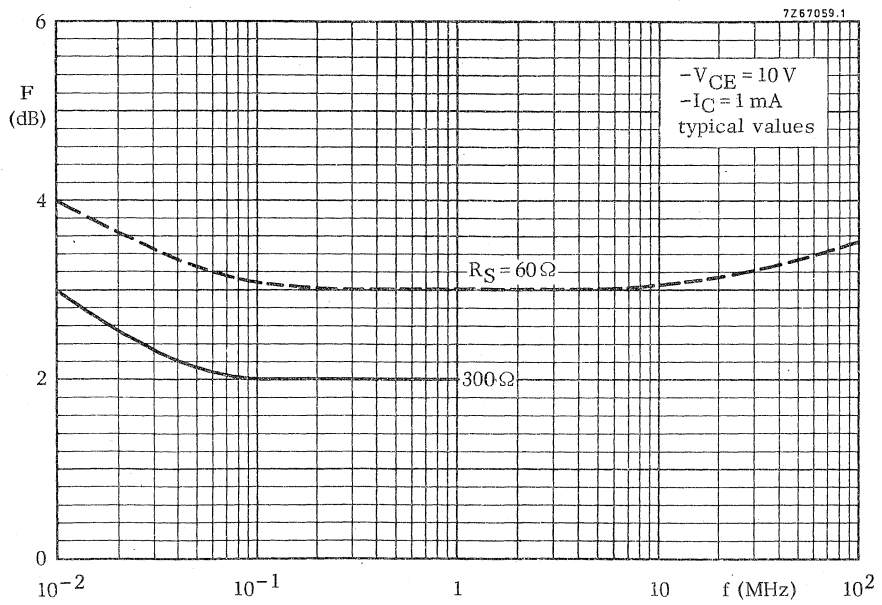
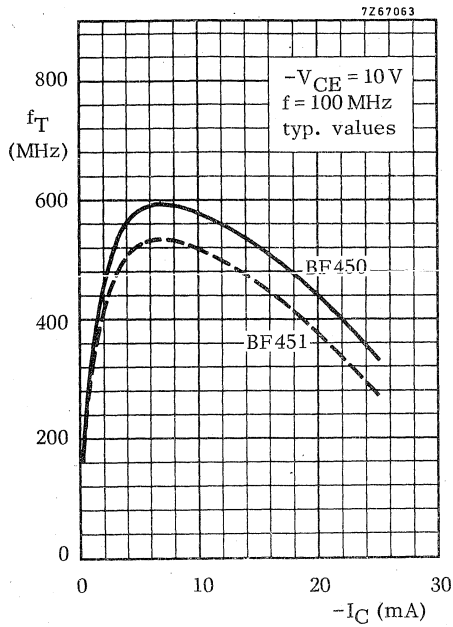

SILICON PLANAR TRANSISTORS FOR VIDEO OUTPUT STAGES

N-P-N transistors in a SOT-32 plastic envelope intended for video output stages in black-and-white and in colour television receivers.

| QUICK REFERENCE DATA | | | | | |
|---|----------------|----------------|-------|-------|------------------|
| | | BF457 | BF458 | BF459 | |
| Collector-base voltage (open emitter) | V_{CBO} max. | 160 | 250 | 300 | V |
| Collector-emitter voltage (open base) | V_{CEO} max. | 160 | 250 | 300 | V |
| Collector current (peak value) | | I_{CM} max. | 300 | | mA |
| Total power dissipation up to $T_{mb} = 90^\circ\text{C}$ | | P_{tot} max. | 6 | | W |
| Junction temperature | | T_j max. | 150 | | $^\circ\text{C}$ |
| D.C. current gain at $T_j = 25^\circ\text{C}$ $I_C = 30\text{ mA}; V_{CE} = 10\text{ V}$ | | h_{FE} | > | 26 | |
| Transition frequency $I_C = 15\text{ mA}; V_{CE} = 10\text{ V}$ | | f_T typ. | 90 | | MHz |
| Feedback capacitance at $f = 1\text{ MHz}$ $I_E = 0; V_{CB} = 30\text{ V}$ | | C_{re} | < | 3.5 | pF |

MECHANICAL DATA

TO-126 (SOT-32)

Collector connected to metal part of mounting surface

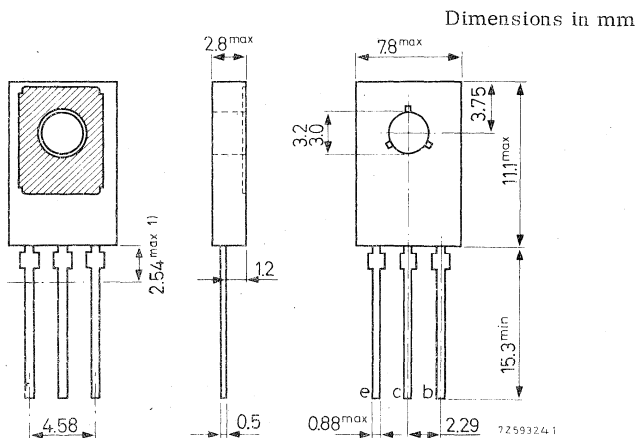

Accessories supplied on request: 56326, 56333

1) Within this region the cross-section of the leads is uncontrolled.

RATINGS Limiting values in accordance with the Absolute Maximum System (IEC134)

| <u>Voltage</u> | | BF457 | BF458 | BF459 | |
|---------------------------------------|----------------|-------|-------|-------|---|
| Collector-base voltage (open emitter) | V_{CBO} max. | 160 | 250 | 300 | V |
| Collector-emitter voltage (open base) | V_{CEO} max. | 160 | 250 | 300 | V |
| Emitter-base voltage (open collector) | V_{EBO} max. | 5 | 5 | 5 | V |

Current

| | | | | |
|--------------------------------|----------|------|-----|----|
| Collector current (d. c.) | I_C | max. | 100 | mA |
| Collector current (peak value) | I_{CM} | max. | 300 | mA |
| Base current (d. c.) | I_B | max. | 50 | mA |

Power dissipation

| | | | | |
|---|-----------|------|---|---|
| Total power dissipation up to $T_{mb} = 90^\circ C$ | P_{tot} | max. | 6 | W |
|---|-----------|------|---|---|

Temperature

| | | | |
|----------------------|-----------|-------------|------------|
| Storage temperature | T_{stg} | -55 to +150 | $^\circ C$ |
| Junction temperature | T_j | max. 150 | $^\circ C$ |

THERMAL RESISTANCE

| | | | | |
|--------------------------------|---------------|---|-----|--------------|
| From junction to ambient | $R_{th j-a}$ | = | 104 | $^\circ C/W$ |
| From junction to mounting base | $R_{th j-mb}$ | = | 10 | $^\circ C/W$ |

CHARACTERISTICS $T_j = 25^\circ\text{C}$ unless otherwise specifiedCollector cut-off current $I_E = 0; V_{CB} = 100\text{ V}$ for BF457 $I_E = 0; V_{CB} = 200\text{ V}$ for BF458 $I_E = 0; V_{CB} = 250\text{ V}$ for BF459 $I_{CBO} < 50\text{ nA}$ Emitter cut-off current $I_C = 0; V_{EB} = 3\text{ V}$ $I_{EBO} < 50\text{ nA}$ D.C. current gain $I_C = 30\text{ mA}; V_{CE} = 10\text{ V}$ $h_{FE} > 26$ Collector-emitter saturation voltage $I_C = 30\text{ mA}; I_B = 6\text{ mA}$ $V_{CEsat} < 1\text{ V}$ High frequency knee voltage at $T_j = 150^\circ\text{C}$ $I_C = 50\text{ mA}$ $V_{CEK} \text{ typ. } 15\text{ V}$

The high frequency knee voltage of a transistor is that value of the collector-emitter voltage at which the small signal gain, measured in a practical circuit, has dropped to 80% of the gain at $V_{CE} = 50\text{ V}$. A further reduction of the collector-emitter voltage results in a rapid increase of the distortion of the signal.

Transition frequency at $f = 100\text{ MHz}$ $I_C = 15\text{ mA}; V_{CE} = 10\text{ V}$ $f_T \text{ typ. } 90\text{ MHz}$ Feedback capacitance at $f = 1\text{ MHz}$ $I_E = 0; V_{CB} = 30\text{ V}$ $C_{re} < 3.5\text{ pF}$ Output capacitance at $f = 1\text{ MHz}$ $I_E = 0; V_{CB} = 30\text{ V}$ $C_{oe} < 4.5\text{ pF}$

7Z67068.1

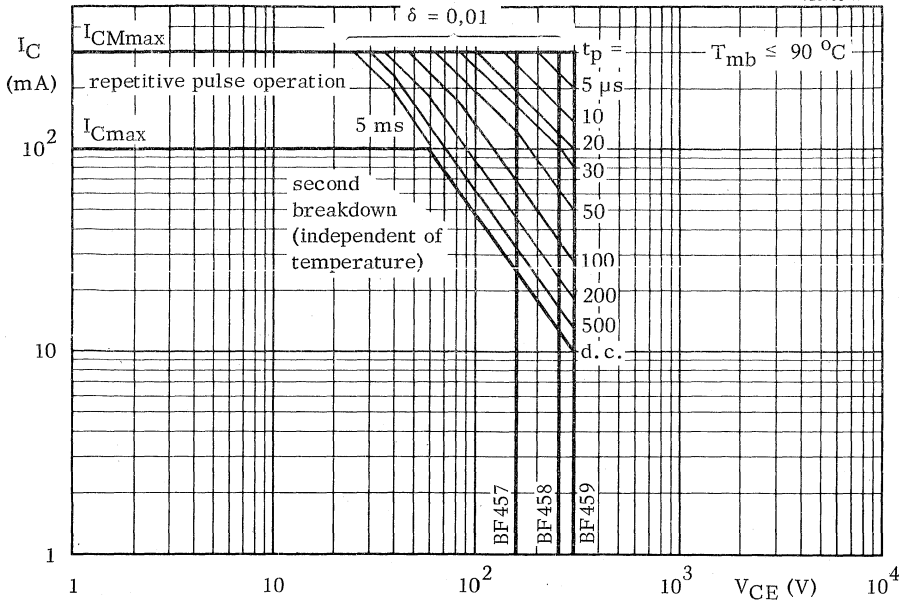

Safe Operating Area with the transistor forward biased

7Z67879

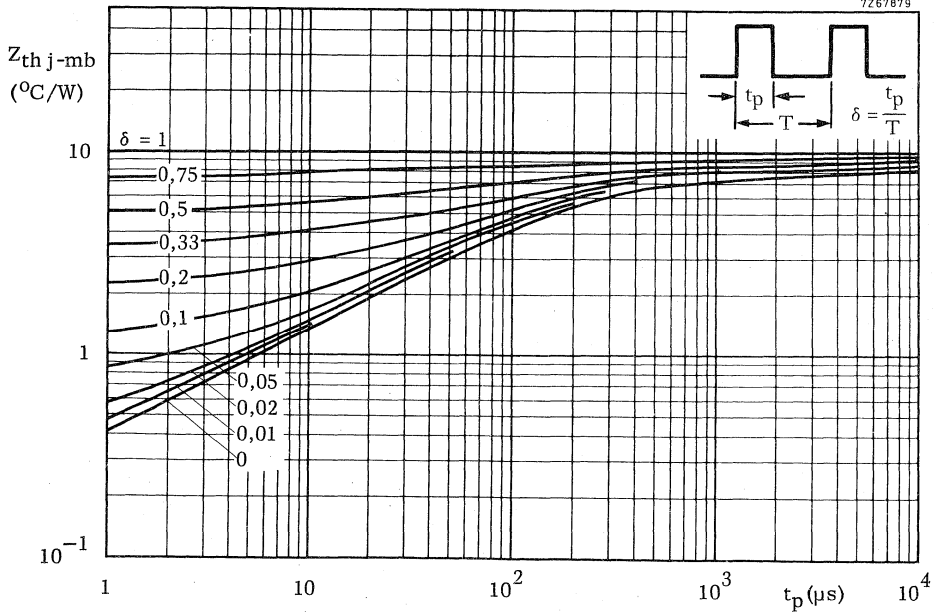

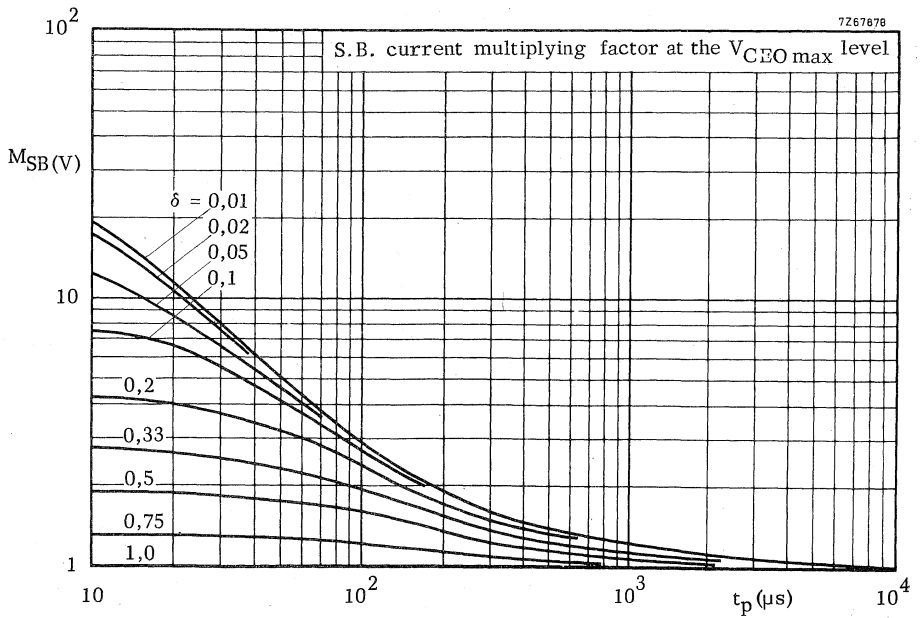
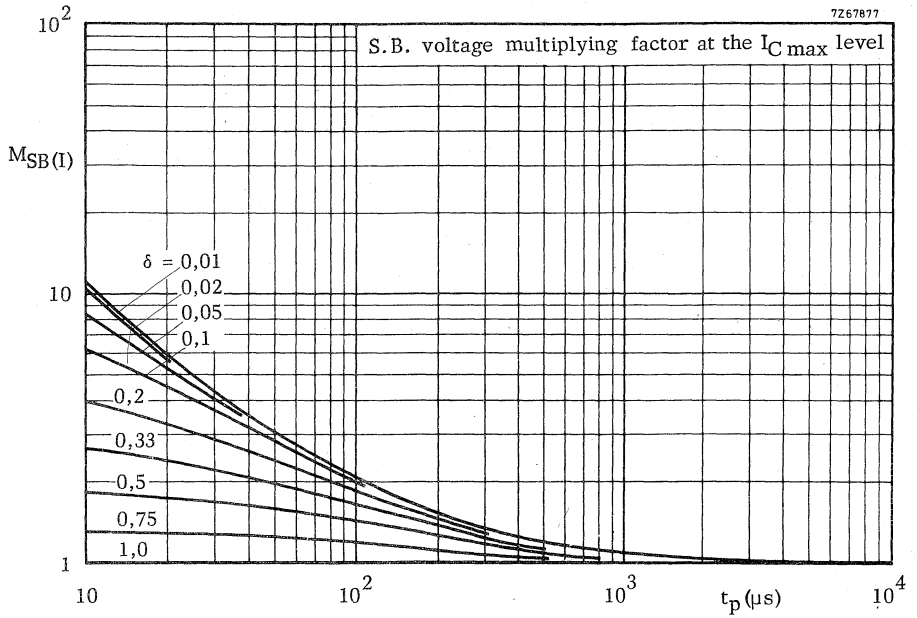

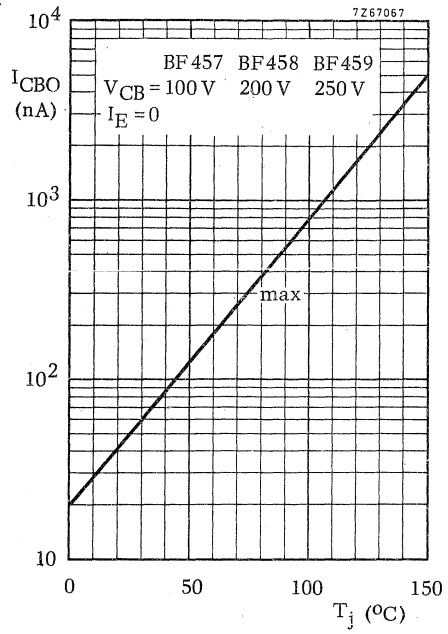
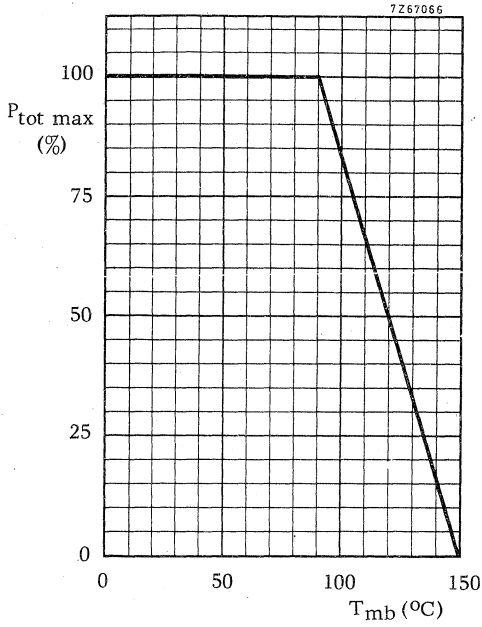

SILICON PLANAR TRANSISTOR

N-P-N transistor in a subminiature plastic T-package, primarily intended for application in non-controlled r. f. stages of television tuners using p-i-n diode attenuators.

| QUICK REFERENCE DATA | | | |
|--|----------------|------|----------------------|
| Collector-base voltage (open emitter) | V_{CBO} | max. | 20 V |
| Collector-emitter voltage (open base) | V_{CEO} | max. | 15 V |
| Collector current (d. c.) | I_C | max. | 20 mA |
| Total power dissipation up to $T_{amb} = 55\text{ }^\circ\text{C}$ | P_{tot} | max. | 140 mW |
| Junction temperature | T_j | max. | 125 $^\circ\text{C}$ |
| Transition frequency $-I_E = 10\text{ mA}$; $V_{CB} = 10\text{ V}$ | f_T | typ. | 1600 MHz |
| Noise figure at $G_S = 20\text{ mA/V}$; $B_S = 0$, $I_C = 10\text{ mA}$, $V_{CB} = 10\text{ V}$, $f = 800\text{ MHz}$ | F | typ. | 3,3 dB |
| Cross modulation ($K = 1\%$) e. m. f. in $75\ \Omega$ | $V_{(int)rms}$ | typ. | 330 mV |

MECHANICAL DATA

Dimensions in mm

SOT-37

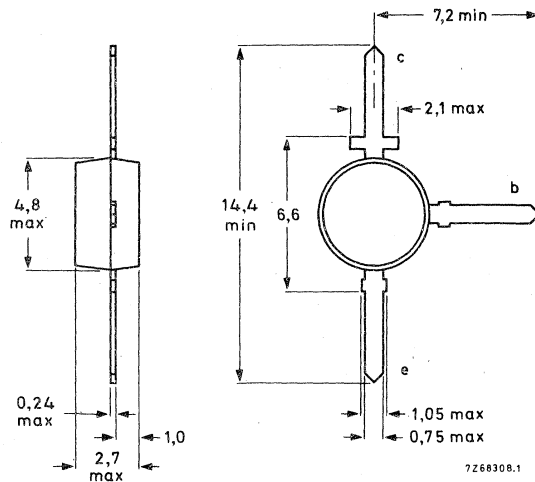

RATINGS Limiting values in accordance with the Absolute Maximum System (IEC 134)

Voltage

| | | | | |
|---------------------------------------|-----------|------|----|---|
| Collector-base voltage (open emitter) | V_{CBO} | max. | 20 | V |
| Collector-emitter voltage (open base) | V_{CEO} | max. | 15 | V |
| Emitter-base voltage (open collector) | V_{EBO} | max. | 2 | V |

Current

| | | | | |
|--------------------------------|----------|------|----|----|
| Collector current (d. c.) | I_C | max. | 20 | mA |
| Collector current (peak value) | I_{CM} | max. | 30 | mA |

Power dissipation

| | | | | |
|--|-----------|------|-----|----|
| Total power dissipation up to $T_{amb} = 55\text{ }^{\circ}\text{C}$ | P_{tot} | max. | 140 | mW |
|--|-----------|------|-----|----|

Temperature

| | | | |
|----------------------|-------|-------------|--------------------|
| Storage temperature | T_S | -55 to +125 | $^{\circ}\text{C}$ |
| Junction temperature | T_j | max. 125 | $^{\circ}\text{C}$ |

THERMAL RESISTANCE

| | | | | |
|--|---------------|---|-----|------------------------------|
| From junction to ambient in free air mounted on a printed wiring board | $R_{th\ j-a}$ | = | 0,5 | $^{\circ}\text{C}/\text{mW}$ |
|--|---------------|---|-----|------------------------------|

CHARACTERISTICS

$T_{amb} = 25\text{ }^{\circ}\text{C}$ unless otherwise specified

Base current

$-I_E = 10\text{ mA}; V_{CB} = 10\text{ V}$ $I_B < 1\text{ mA}$

Emitter-base voltage

$-I_E = 10\text{ mA}; V_{CB} = 10\text{ V}$ $-V_{EB}$ typ. 0,75 V

Transition frequency

$-I_E = 10\text{ mA}; V_{CB} = 10\text{ V}$ f_T typ. 1600 MHz

Noise figure (common base)

$-I_E = 10\text{ mA}; V_{CB} = 10\text{ V}$
 $G_S = 20\text{ mA/V}; B_S = 0; f = 800\text{ MHz}$ F typ. 3,3 dB

$-I_E = 10\text{ mA}; V_{CB} = 10\text{ V}$
 $G_S = 20\text{ mA/V}; B_S = 0; f = 200\text{ MHz}$ F typ. 2,7 dB

Transducer gain (common base)

$-I_E = 10\text{ mA}; V_{CB} = 10\text{ V}; f = 900\text{ MHz}$
 $G_S = 20\text{ mA/V}; B_S = 0$
 $G_L = 2\text{ mA/V}; B_L = \text{tuned}$ G_{tr} typ. 15 dB

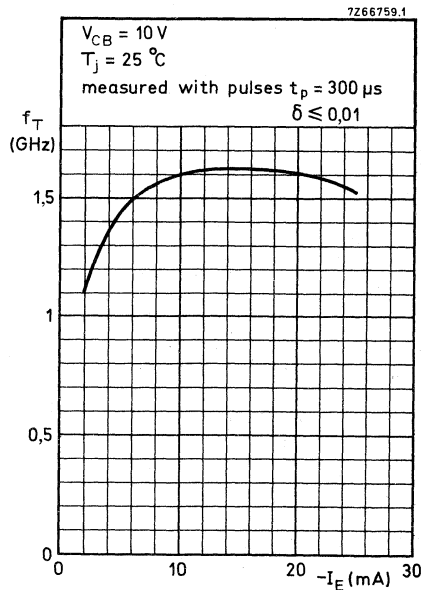

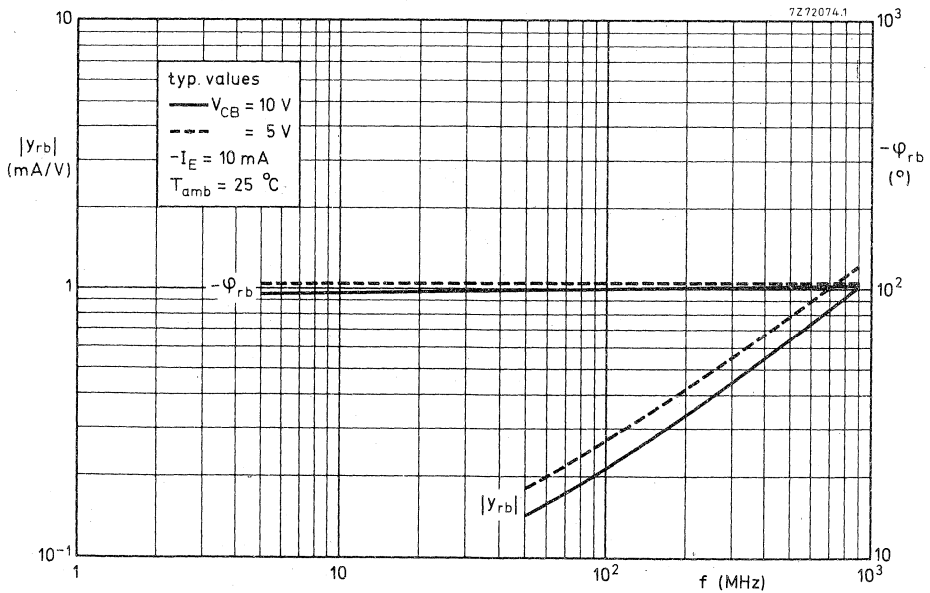
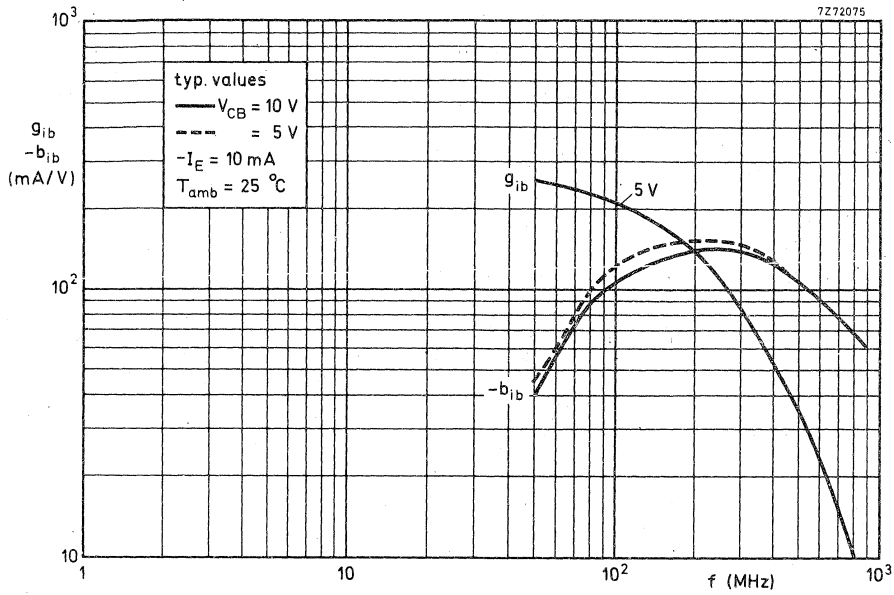

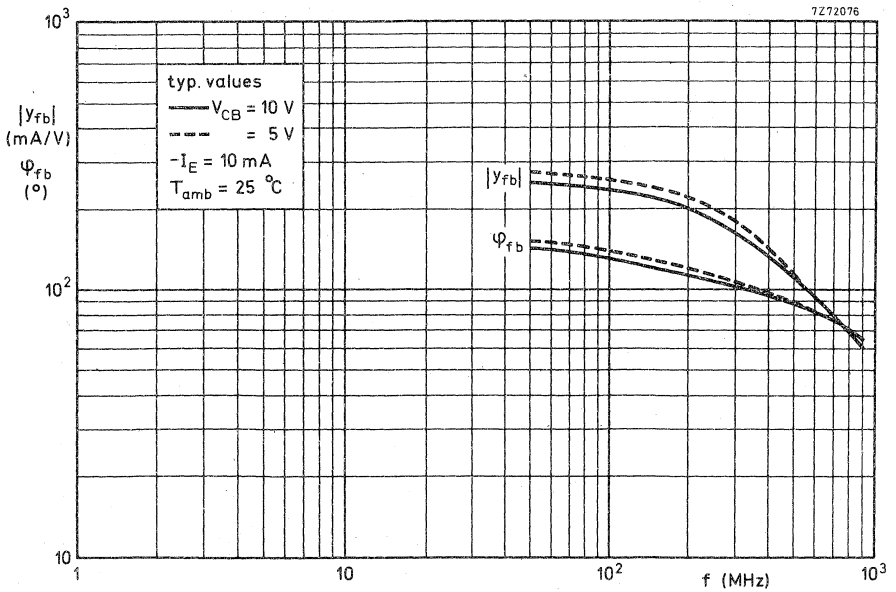
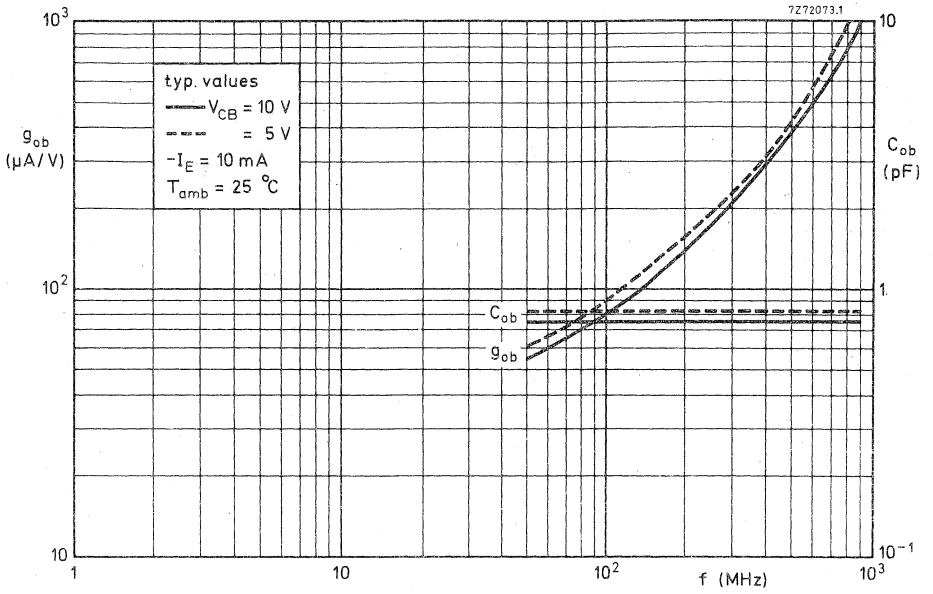

$-I_E = 10 \text{ mA}$; $V_{CB} = 10 \text{ V}$; $f = 100 \text{ MHz}$; $T_{amb} = 25^\circ \text{C}$

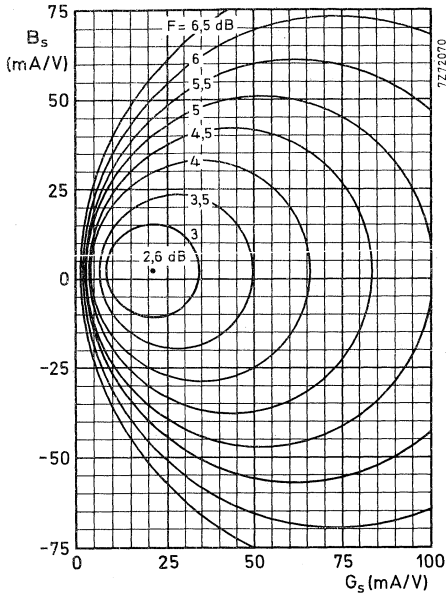

$-I_E = 10 \text{ mA}$; $V_{CB} = 10 \text{ V}$; $f = 200 \text{ MHz}$; $T_{amb} = 25^\circ \text{C}$

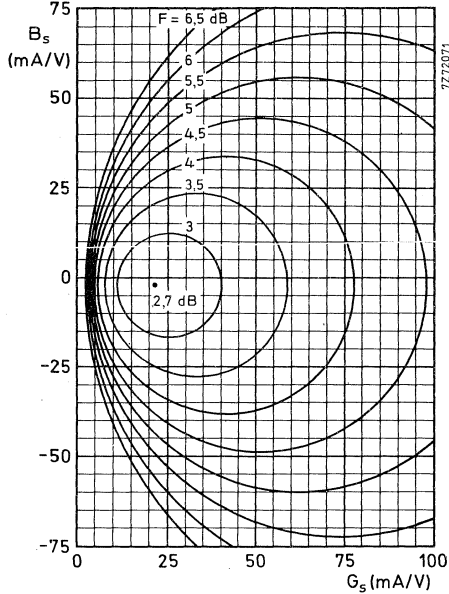

$-I_E = 10 \text{ mA}$; $V_{CB} = 10 \text{ V}$; $f = 500 \text{ MHz}$; $T_{amb} = 25^\circ \text{C}$

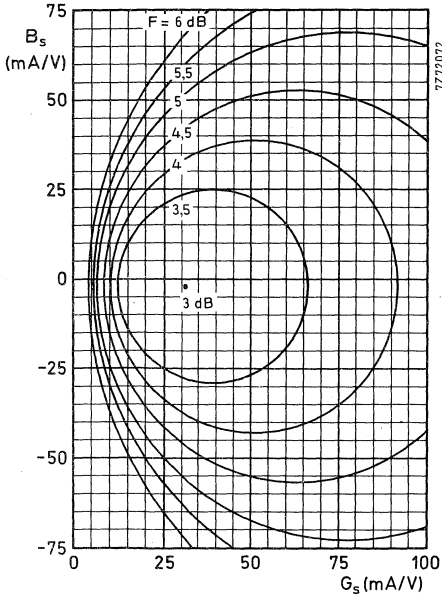

$-I_E = 10 \text{ mA}$; $V_{CB} = 10 \text{ V}$; $f = 800 \text{ MHz}$; $T_{amb} = 25^\circ \text{C}$

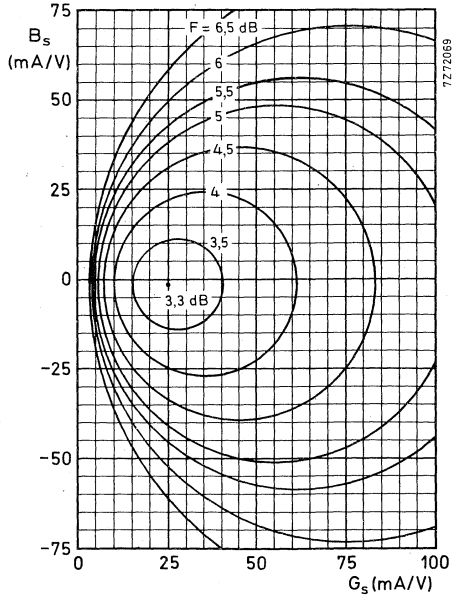

APPLICATION INFORMATION

1. U.H.F. stage with BF480

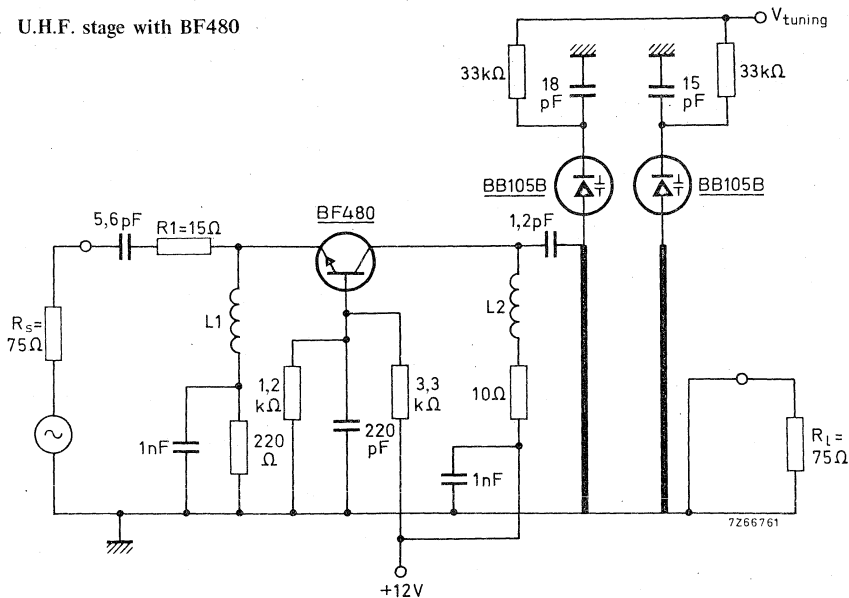

$L_1 = 6$ turns, $\varnothing 3$ mm
 $L_2 = 4,5$ turns, $\varnothing 3$ mm

PERFORMANCE at $T_{amb} = 25$ °C

Measuring frequency

$f_i = 800$ MHz

3 dB bandwidth

B_{3dB} typ. 25 MHz

Emitter current

$-I_E$ typ. 10,3 mA

Collector-emitter voltage

V_{CE} typ. 9,7 V

Transducer gain

G_{tr} typ. 8,5 dB

Noise figure including influence of

a. mixer stage with a noise figure of 10 dB

b. $R_1 = 15$ Ω

F typ. 6,5 dB

Voltage standing wave ratio (incl. $R_1 = 15$ Ω)

VSWR < 4

Cross modulation ¹⁾

Interference voltage for $K = 1$ %

$V_{(int)rms}$ typ. 300 mV

¹⁾ See definition next page.

APPLICATION INFORMATION (continued)

2. V.H.F. stage with BF480

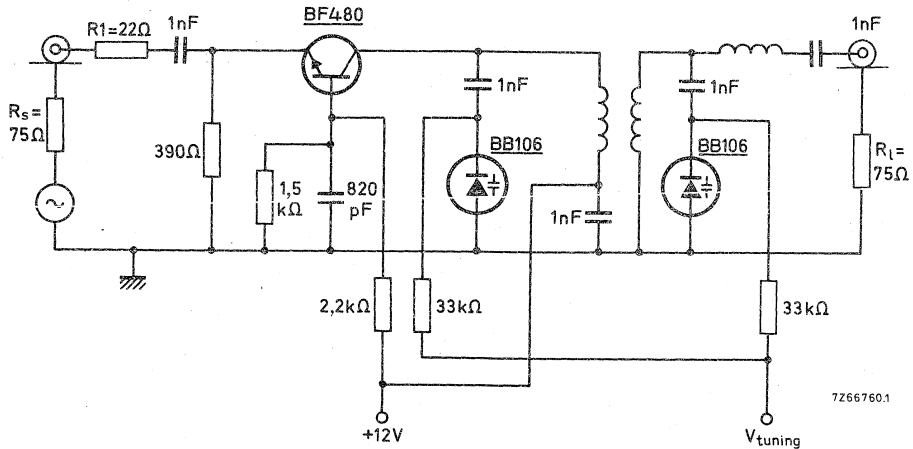

PERFORMANCE at $T_{amb} = 25\text{ }^{\circ}\text{C}$

| | | | | |
|---|----------------|------|-----|-----|
| Measuring frequency | f_i | = | 200 | MHz |
| 3 dB bandwidth | B_{3dB} | typ. | 13 | MHz |
| Emitter current | $-I_E$ | typ. | 10 | mA |
| Collector-emitter voltage | V_{CE} | typ. | 8,1 | V |
| <u>Transducer gain</u> | G_{tr} | typ. | 8,5 | dB |
| <u>Noise figure including influence of</u> | | | | |
| a. mixer stage with a noise figure of 10 dB | | | | |
| b. $R_1 = 22\text{ }\Omega$ | F | typ. | 6,5 | dB |
| Voltage standing wave ratio (incl. $R_1 = 22\text{ }\Omega$) | VSWR | < | 3 | |
| <u>Cross modulation</u> ¹⁾ | | | | |
| Interference voltage for $K = 1\text{ }\%$ | $V_{(int)rms}$ | typ. | 330 | mV |

¹⁾ Cross modulation is defined here as the e.m.f. in $75\text{ }\Omega$ of an unwanted signal with 80 % modulation depth, giving 0,8 % modulation depth on the wanted signal.

SILICON PLANAR EPITAXIAL TRANSISTOR

N-P-N transistor in a plastic TO-92 variant intended for h.f. applications in radio and television receivers; it is especially recommended for f.m. tuners, low noise a.m. mixer -oscillators with high source impedance and i.f. amplifiers in a.m./f.m. receivers where a high current gain is of importance.

| QUICK REFERENCE DATA | | | |
|---|-----------|------|----------------------|
| Collector-base voltage (open emitter) | V_{CB0} | max. | 30 V |
| Collector-emitter voltage (open base) | V_{CE0} | max. | 20 V |
| Collector current (d.c.) | I_C | max. | 30 mA |
| Total power dissipation up to $T_{amb} = 75\text{ }^\circ\text{C}$ | P_{tot} | max. | 300 mW |
| Junction temperature | T_j | max. | 150 $^\circ\text{C}$ |
| D.C. current gain at $T_j = 25\text{ }^\circ\text{C}$ $I_C = 1\text{ mA}; V_{CE} = 10\text{ V}$ | h_{FE} | typ. | 115 |
| Transition frequency $I_C = 1\text{ mA}; V_{CE} = 10\text{ V}$ | f_T | typ. | 260 MHz |
| Noise figure at $f = 100\text{ MHz}$ $I_C = 1\text{ mA}; V_{CE} = 10\text{ V}; G_S = 10\text{ mA/V}$ | F | typ. | 4 dB |
| Conversion noise figure at $f = 1\text{ MHz}$ $I_C = 1\text{ mA}; V_{CE} = 10\text{ V}; G_S = 1,2\text{ mA/V}$ | F_c | typ. | 2 dB |

MECHANICAL DATA

Dimensions in mm

TO-92 variant

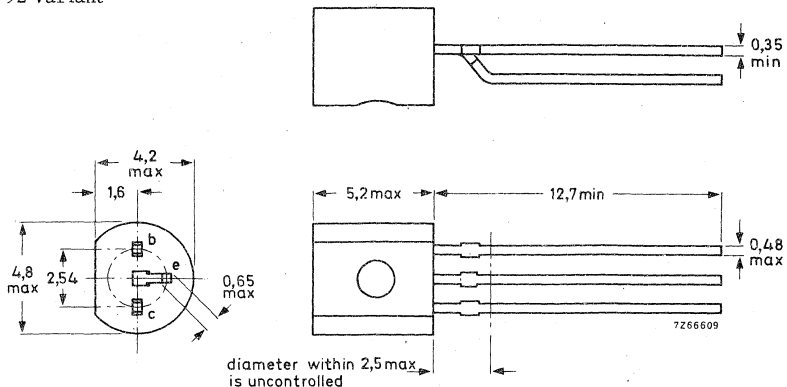

RATINGS Limiting values in accordance with the Absolute Maximum System (IEC134)

Voltages

| | | | |
|--|-----------|------|------|
| Collector-base voltage (open emitter) | V_{CBO} | max. | 30 V |
| Collector-emitter voltage (open base) (See also page 4) | V_{CEO} | max. | 20 V |
| Emitter-base voltage (open collector) | V_{EBO} | max. | 5 V |

Currents

| | | | |
|--------------------------------|----------|------|-------|
| Collector current (d. c.) | I_C | max. | 30 mA |
| Collector current (peak value) | I_{CM} | max. | 30 mA |

Power dissipation

| | | | |
|--|-----------|------|--------|
| Total power dissipation up to $T_{amb} = 75\text{ }^\circ\text{C}$ | P_{tot} | max. | 300 mW |
|--|-----------|------|--------|

Temperatures

| | | | |
|----------------------|-----------|-------------|----------------------|
| Storage temperature | T_{stg} | -65 to +150 | $^\circ\text{C}$ |
| Junction temperature | T_j | max. | 150 $^\circ\text{C}$ |

THERMAL RESISTANCE

| | | | |
|--------------------------------------|---------------|---|---------------------------------|
| From junction to ambient in free air | $R_{th\ j-a}$ | = | 0,25 $^\circ\text{C}/\text{mW}$ |
|--------------------------------------|---------------|---|---------------------------------|

CHARACTERISTICS

$T_j = 25\text{ }^\circ\text{C}$

Base-emitter voltage ²⁾

| | | |
|---|----------|----------------|
| $I_C = 1\text{ mA}; V_{CE} = 10\text{ V}$ | V_{BE} | 0,65 to 0,74 V |
|---|----------|----------------|

Base current

| | | |
|---|-------|---|
| $I_C = 1\text{ mA}; V_{CE} = 10\text{ V}$ | I_B | 4,5 to 15 μA typ. 8,7 μA |
|---|-------|---|

Feedback capacitance at $f = 0,45\text{ MHz}$

| | | |
|---|----------|--------------|
| $I_C = 1\text{ mA}; V_{CE} = 10\text{ V}$ | C_{re} | typ. 0,85 pF |
|---|----------|--------------|

1) V_{BE} decreases by about 1,7 mV/ $^\circ\text{C}$ with increasing temperature.

CHARACTERISTICS (continued)

$T_j = 25\text{ }^\circ\text{C}$

Transition frequency

| | | | | |
|---|-------|------|-----|-----|
| $I_C = 1\text{ mA}; V_{CE} = 10\text{ V}$ | f_T | typ. | 260 | MHz |
|---|-------|------|-----|-----|

Noise figure

| | | | | |
|---|-----|------|-----|----|
| $I_C = 1\text{ mA}; V_{CE} = 10\text{ V}$ | | | | |
| $G_S = 2\text{ mA/V}; f = 0,2\text{ MHz}$ | F | typ. | 1,5 | dB |
| $G_S = 1,5\text{ mA/V}; f = 1,0\text{ MHz}$ | F | typ. | 1,2 | dB |
| $G_S = 10\text{ mA/V}; f = 100\text{ MHz}$ | F | typ. | 4 | dB |

Conversion noise figure

| | | | | |
|---|-------|------|---|----|
| $I_C = 1\text{ mA}; V_{CE} = 10\text{ V}$ | | | | |
| $G_S = 0,6\text{ mA/V}; f = 0,2\text{ MHz}$ | F_C | typ. | 3 | dB |
| $G_S = 1,2\text{ mA/V}; f = 1,0\text{ MHz}$ | F_C | typ. | 2 | dB |

y parameters at $f = 100\text{ MHz}$ (common base)

| | | | | |
|--|----------------|------|--------------|-----------------|
| $I_C = 1\text{ mA}; V_{CE} = 10\text{ V}$ (lead length = 3 mm) | | | | |
| Input conductance | g_{ib} | typ. | 32 | mA/V |
| Input susceptance | $-b_{ib}$ | typ. | 3 | mA/V |
| Feedback admittance | $ y_{rb} $ | typ. | 500 | $\mu\text{A/V}$ |
| Phase angle of feedback admittance | φ_{rb} | typ. | 272 $^\circ$ | |
| Transfer admittance | $ y_{fb} $ | typ. | 33 | mA/V |
| Phase angle of transfer admittance | φ_{fb} | typ. | 150 $^\circ$ | |
| Output conductance | g_{ob} | typ. | 22 | $\mu\text{A/V}$ |
| Output susceptance | b_{ob} | typ. | 1,1 | mA/V |

y parameters (common emitter)

| | | | |
|--|-----------------|-----------------------|-----------------------|
| $I_C = 1\text{ mA}; V_{CE} = 10\text{ V}$ (lead length = 3 mm) | | $f = 10,7\text{ MHz}$ | $f = 0,45\text{ MHz}$ |
| Input conductance | $g_{ie} < 0,64$ | | 0,54 mA/V |
| Output conductance | $g_{oe} < 13,5$ | | 11,5 $\mu\text{A/V}$ |

7208228.2

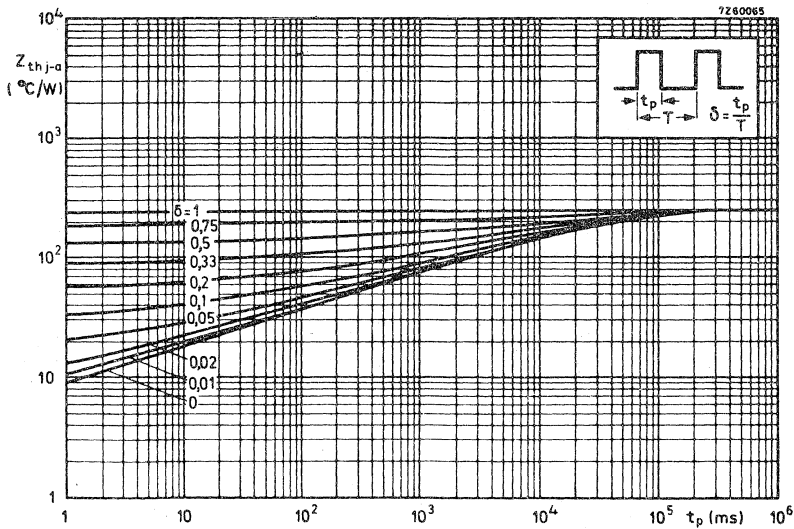
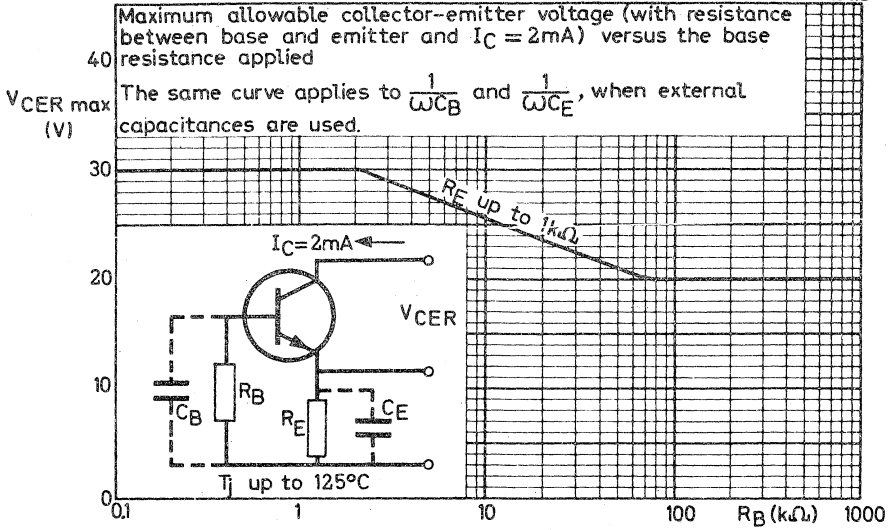

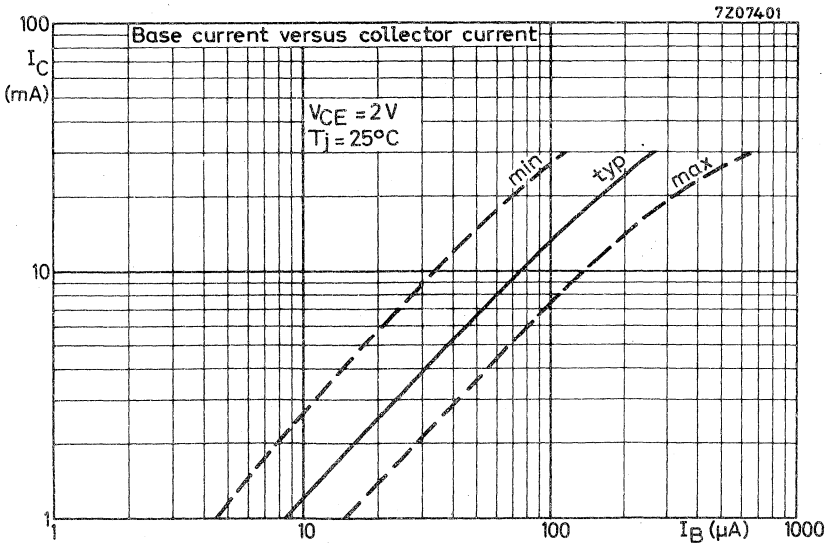
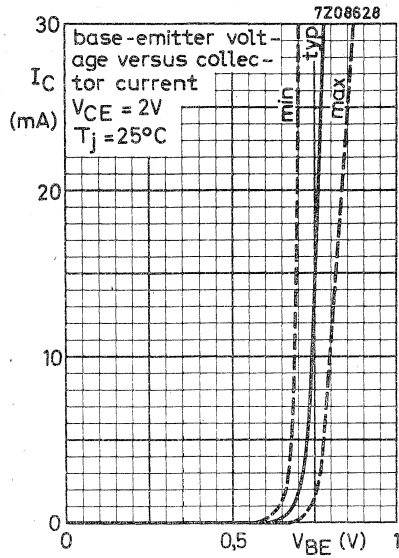

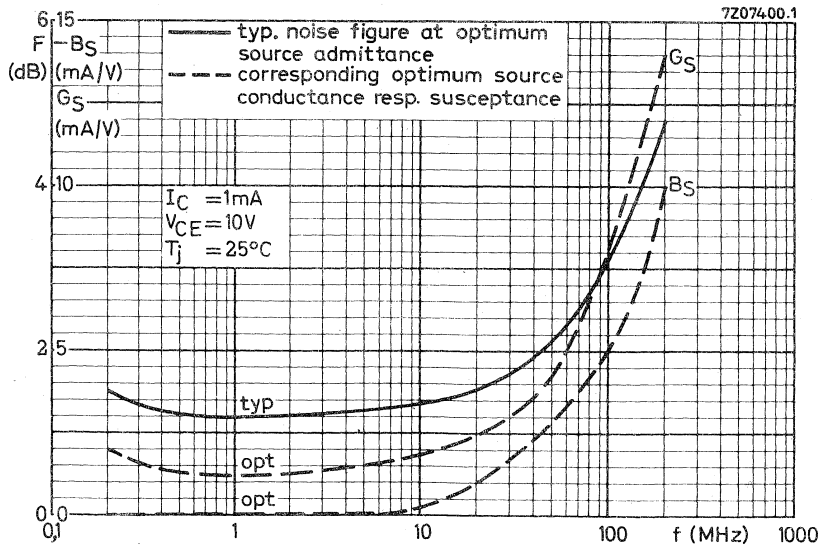
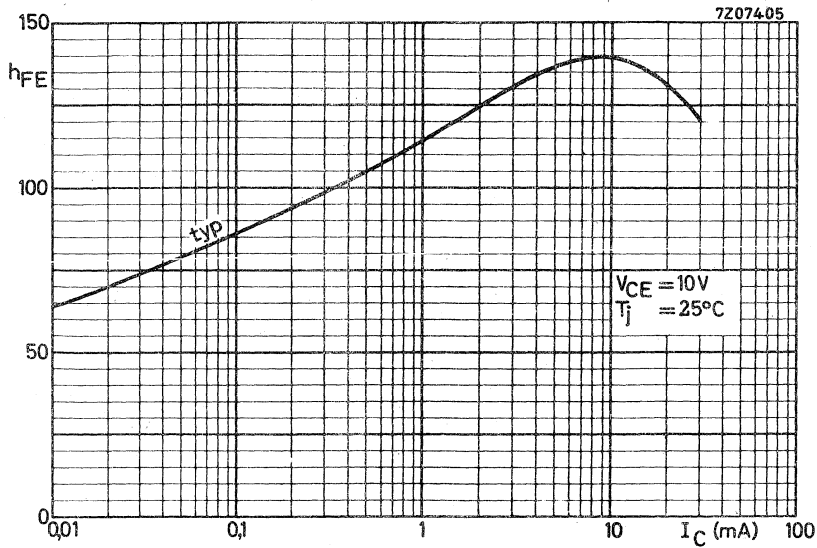

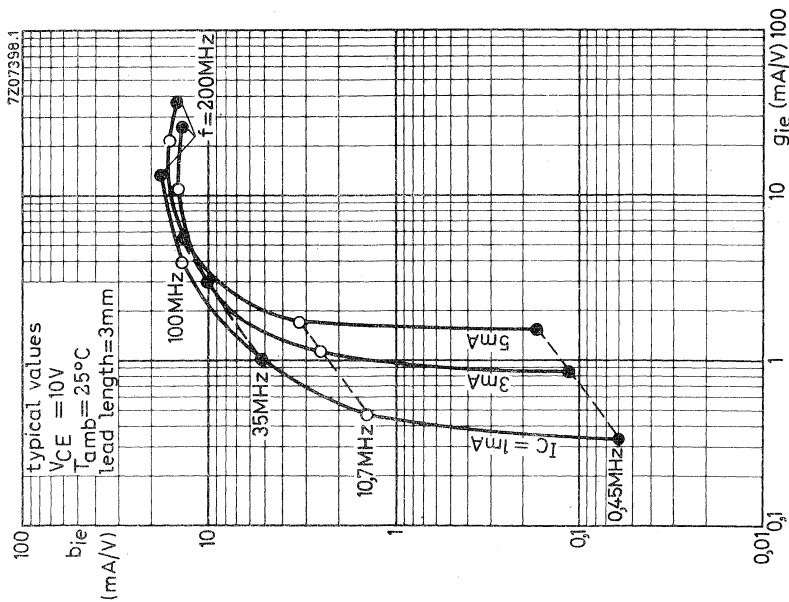
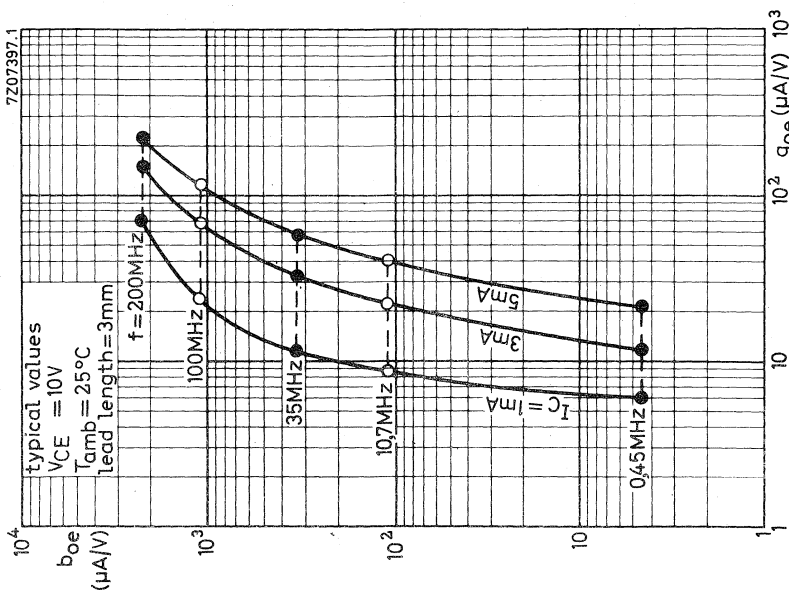

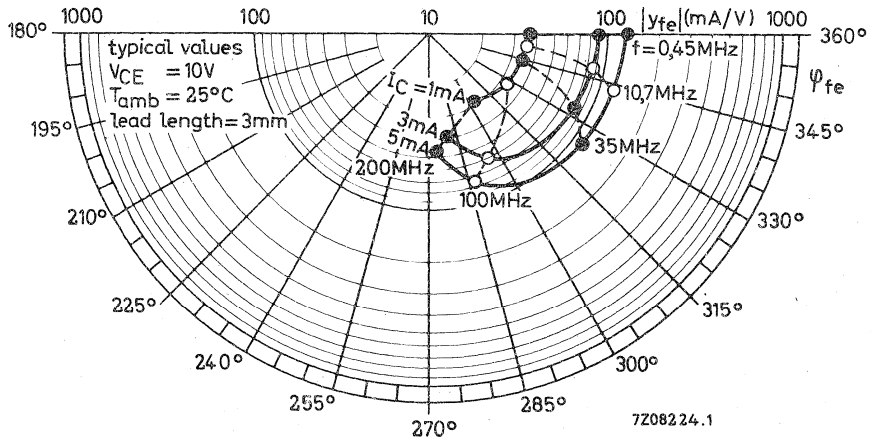
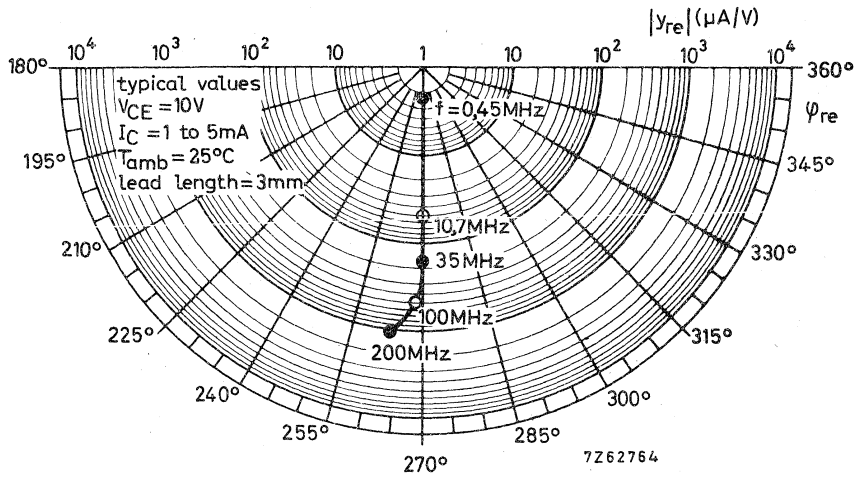

SILICON PLANAR EPITAXIAL TRANSISTOR

N-P-N transistor in a plastic TO-92 variant intended for h. f. applications in radio and television receivers; it is especially recommended for f. m. tuners, i. f. amplifiers in a. m. /f. m. receivers where a low transistor output conductance is of importance, a. m. input stages of car radios where a low noise figure at low source impedance is required.

| QUICK REFERENCE DATA | | | | |
|---|-----------|------|-----|------------------|
| Collector-base voltage (open emitter) | V_{CBO} | max. | 30 | V |
| Collector-emitter voltage (open base) | V_{CEO} | max. | 20 | V |
| Collector current (d. c.) | I_C | max. | 30 | mA |
| Total power dissipation up to $T_{amb} = 75\text{ }^\circ\text{C}$ | P_{tot} | max. | 300 | mW |
| Junction temperature | T_j | max. | 150 | $^\circ\text{C}$ |
| D. C. current gain at $T_j = 25\text{ }^\circ\text{C}$ $I_C = 1\text{ mA}; V_{CE} = 10\text{ V}$ | h_{FE} | typ. | 67 | |
| Transition frequency $I_C = 1\text{ mA}; V_{CE} = 10\text{ V}$ | f_T | typ. | 200 | MHz |
| Noise figure $I_C = 1\text{ mA}; V_{CE} = 10\text{ V}$ $G_S = 20\text{ mA/V}; f = 1\text{ MHz}$ | F | typ. | 3,5 | dB |
| $G_S = 10\text{ mA/V}; f = 100\text{ MHz}$ | F | typ. | 4 | dB |

MECHANICAL DATA

Dimensions in mm

TO-92 variant

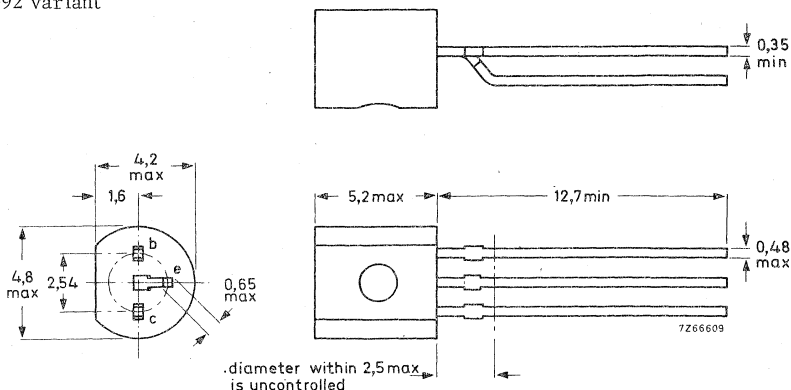

RATINGS Limiting values in accordance with the Absolute Maximum System (IEC134)

Voltages

| | | | | |
|--|-----------|------|----|---|
| Collector-base voltage (open emitter) | V_{CBO} | max. | 30 | V |
| Collector-emitter voltage (open base) (See also page 4) | V_{CEO} | max. | 20 | V |
| Emitter-base voltage (open collector) | V_{EBO} | max. | 5 | V |

Currents

| | | | | |
|--------------------------------|----------|------|----|----|
| Collector current (d.c.) | I_C | max. | 30 | mA |
| Collector current (peak value) | I_{CM} | max. | 30 | mA |

Power dissipation

| | | | | |
|--|-----------|------|-----|----|
| Total power dissipation up to $T_{amb} = 75\text{ }^\circ\text{C}$ | P_{tot} | max. | 300 | mW |
|--|-----------|------|-----|----|

Temperatures

| | | | |
|----------------------|-----------|-------------|------------------|
| Storage temperature | T_{stg} | -65 to +150 | $^\circ\text{C}$ |
| Junction temperature | T_j | max. 150 | $^\circ\text{C}$ |

THERMAL RESISTANCE

| | | | | |
|--------------------------------------|---------------|---|------|----------------------------|
| From junction to ambient in free air | $R_{th\ j-a}$ | = | 0,25 | $^\circ\text{C}/\text{mW}$ |
|--------------------------------------|---------------|---|------|----------------------------|

CHARACTERISTICS

$T_j = 25\text{ }^\circ\text{C}$

Base-emitter voltage ²⁾

| | | | |
|---|----------|--------------|---|
| $I_C = 1\text{ mA}; V_{CE} = 10\text{ V}$ | V_{BE} | 0,65 to 0,74 | V |
|---|----------|--------------|---|

Base current

| | | | |
|---|-------|------|---|
| $I_C = 1\text{ mA}; V_{CE} = 10\text{ V}$ | I_B | typ. | 8 to 28 μA 15 μA |
|---|-------|------|---|

Feedback capacitance at $f = 0,45\text{ MHz}$

| | | | | |
|---|----------|------|------|----|
| $I_C = 1\text{ mA}; V_{CE} = 10\text{ V}$ | C_{re} | typ. | 0,85 | pF |
|---|----------|------|------|----|

¹⁾ V_{BE} decreases by about 1,7 mV/ $^\circ\text{C}$ with increasing temperature.

CHARACTERISTICS (continued)

$T_j = 25\text{ }^\circ\text{C}$

Transition frequency

$I_C = 1\text{ mA}; V_{CE} = 10\text{ V}$ f_T typ. 200 MHz

Noise figure

$I_C = 1\text{ mA}; V_{CE} = 10\text{ V}$
 $G_S = 20\text{ mA/V}; f = 1\text{ MHz}$ F typ. 3,5 dB
 $G_S = 10\text{ mA/V}; f = 100\text{ MHz}$ F typ. 4 dB

Conversion noise figure

$I_C = 1\text{ mA}; V_{CE} = 10\text{ V}$
 $G_S = 1,2\text{ mA/V}; f = 0,2\text{ MHz}$ F_c typ. 4 dB
 $G_S = 1,5\text{ mA/V}; f = 1\text{ MHz}$ F_c typ. 2,5 dB

y parameters at $f = 100\text{ MHz}$ (common base)

$I_C = 1\text{ mA}; V_{CE} = 10\text{ V}$ (lead length = 3 mm)

| | | | | |
|------------------------------------|----------------|------|--------------|-----------------|
| Input conductance | g_{ib} | typ. | 34 | mA/V |
| Input susceptance | $-b_{ib}$ | typ. | 1 | mA/V |
| Feedback admittance | $ y_{rb} $ | typ. | 490 | $\mu\text{A/V}$ |
| Phase angle of feedback admittance | φ_{rb} | typ. | 272 $^\circ$ | |
| Transfer admittance | $ y_{fb} $ | typ. | 34 | mA/V |
| Phase angle of transfer admittance | φ_{fb} | typ. | 144 $^\circ$ | |
| Output conductance | g_{ob} | typ. | 12 | $\mu\text{A/V}$ |
| Output susceptance | b_{ob} | typ. | 1,1 | mA/V |

y parameters (common emitter)

$I_C = 1\text{ mA}; V_{CE} = 10\text{ V}$ (lead length = 3 mm)

| | | |
|--------------------|-----------------------|-----------------------|
| | $f = 10,7\text{ MHz}$ | $f = 0,45\text{ MHz}$ |
| Input conductance | $g_{ie} < 0,96$ | 0,86 mA/V |
| Output conductance | $g_{oe} < 9,5$ | 7,0 $\mu\text{A/V}$ |

7208228.2

Maximum allowable collector-emitter voltage (with resistance between base and emitter and $I_C = 2\text{mA}$) versus the base resistance applied

$V_{CER\ max}$ (V) The same curve applies to $\frac{1}{\omega C_B}$ and $\frac{1}{\omega C_E}$, when external capacitances are used.

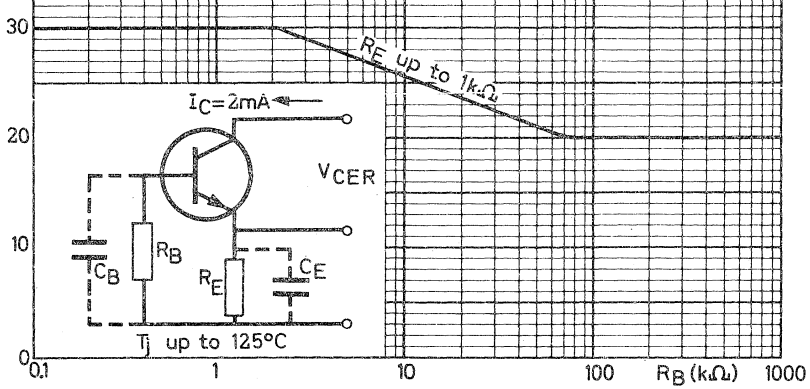

7260065

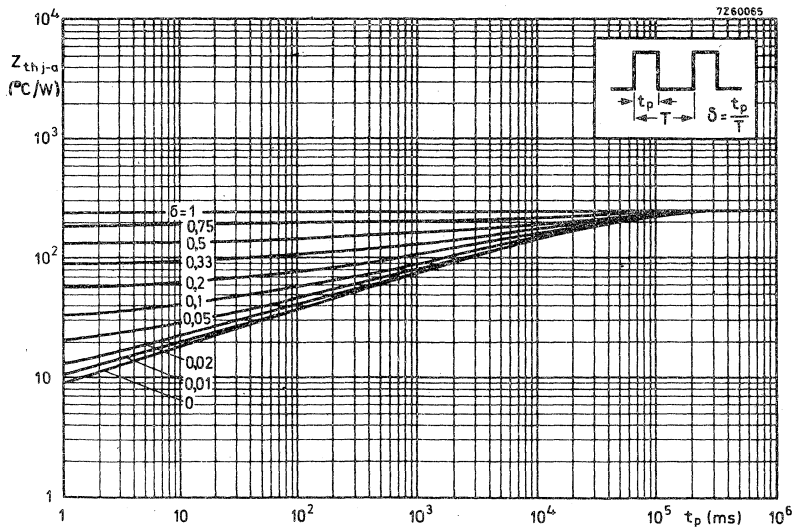

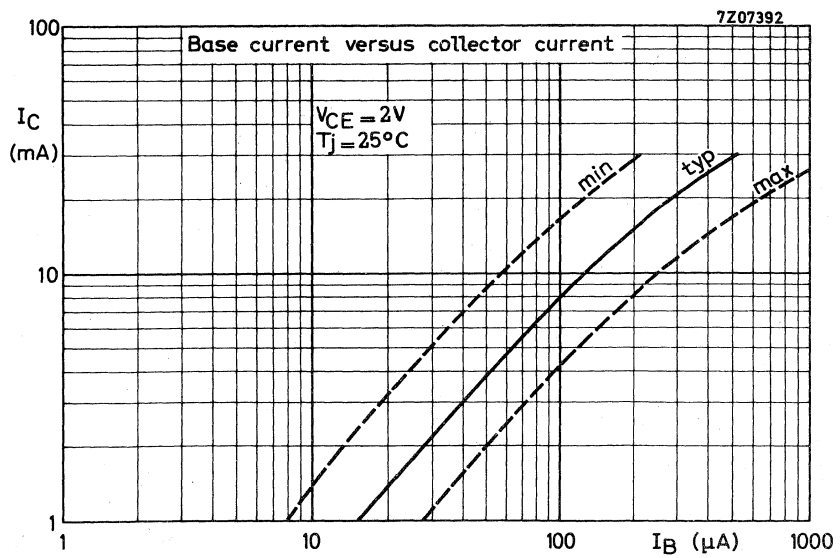
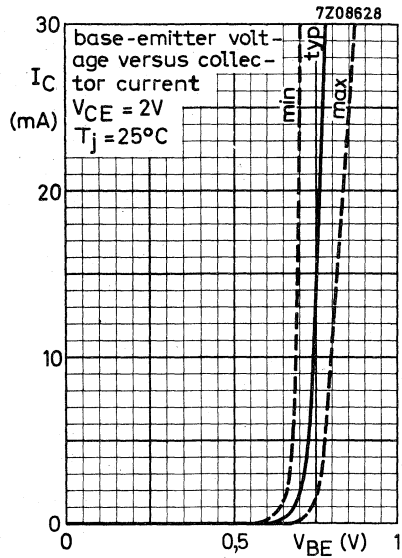

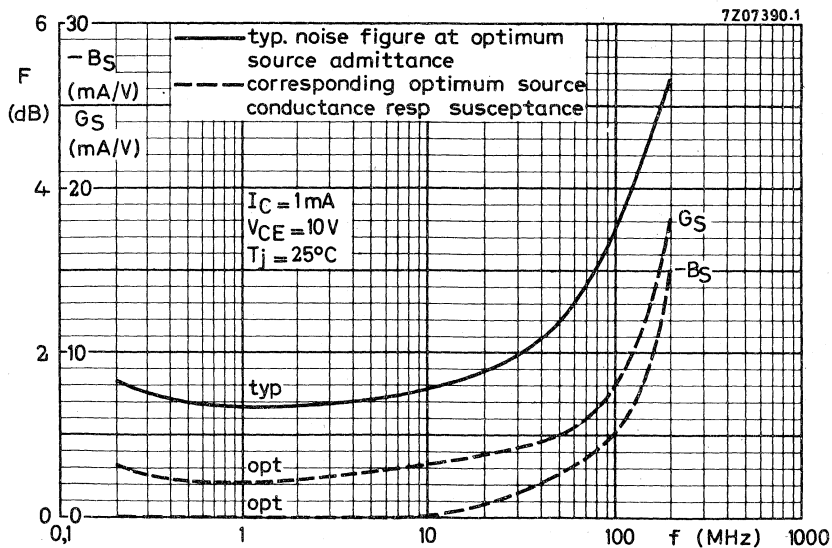
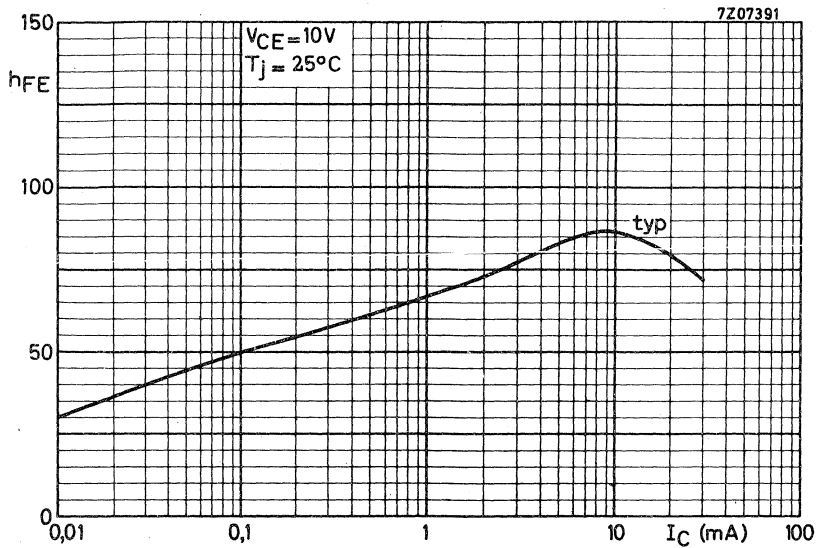

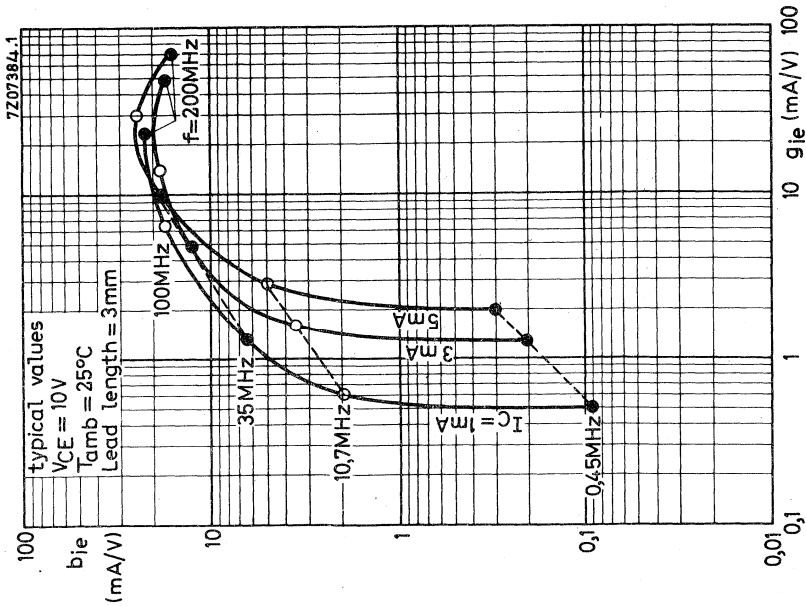
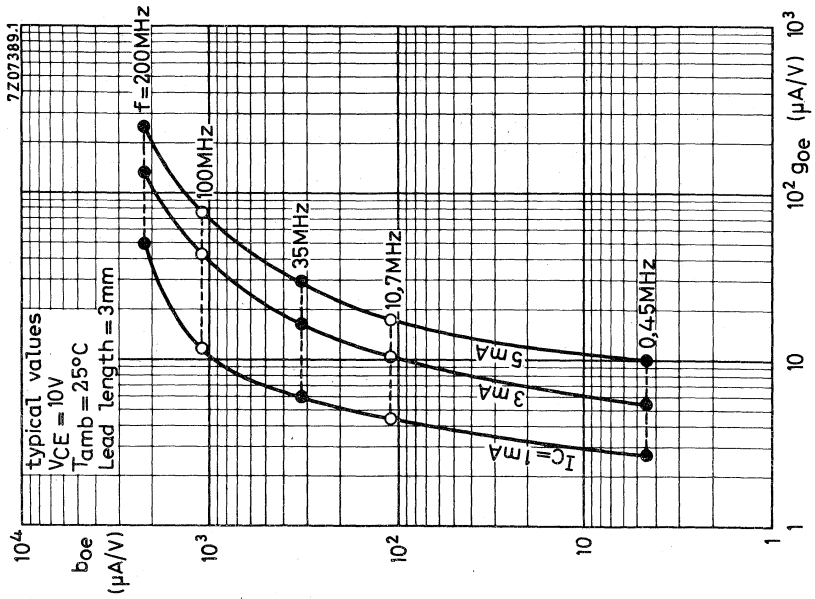

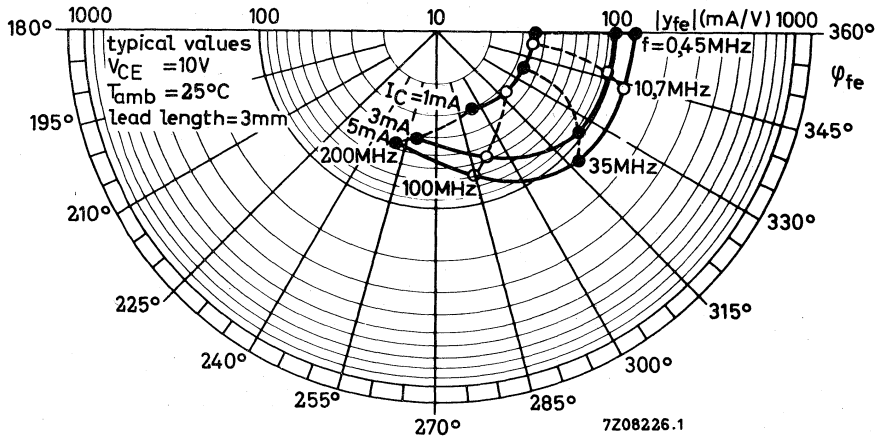
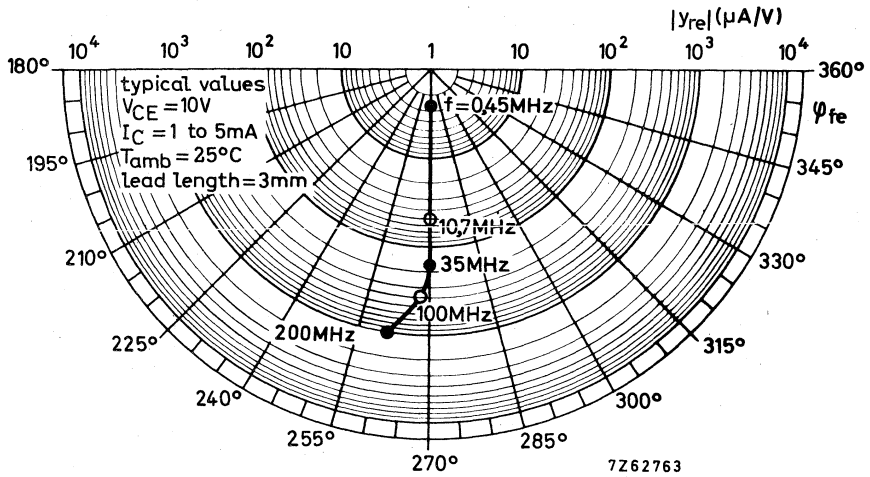

SILICON PLANAR EPITAXIAL TRANSISTOR

N-P-N multi-emitter transistor in a capstan envelope. The transistor has extremely good intermodulation properties and high power gain.

The device is primarily intended for:

- a Final and driver stages of channel and band aerial amplifiers with high output power for band I, II, III and IV/V (40-860 MHz).
- b Final and driver stages of wideband amplifiers (40-230 MHz).
- c Final stages of the wideband vertical amplifier in high-speed oscilloscopes.
- d Frequency multiplier and oscillator circuits.

QUICK REFERENCE DATA

| | | | | |
|--|------------|------|------|--------------------|
| Collector-base voltage (open emitter; peak value) | V_{CBOM} | max. | 40 | V |
| Collector-emitter voltage (open base) | V_{CEO} | max. | 25 | V |
| Collector current (peak value) | I_{CM} | max. | 500 | mA |
| Total power dissipation up to $T_{mb} = 60\text{ }^{\circ}\text{C}$; $f \geq 1\text{ MHz}$ | P_{tot} | max. | 3,5 | W |
| Junction temperature | T_j | max. | 150 | $^{\circ}\text{C}$ |
| Transition frequency at $f = 500\text{ MHz}$ $I_C = 75\text{ mA}$; $V_{CE} = 20\text{ V}$ | f_T | > | 1200 | MHz |
| Output power at $f = 200\text{ MHz}$ $I_C = 70\text{ mA}$; $V_{CE} = 20\text{ V}$; $d_{im} = -30\text{ dB}$ | P_o | typ. | 150 | mW |
| Power gain at $f = 200\text{ MHz}$ $I_C = 70\text{ mA}$; $V_{CE} = 20\text{ V}$ | G_p | typ. | 16 | dB |

MECHANICAL DATA See page 2.

MECHANICAL DATA

SOT-48

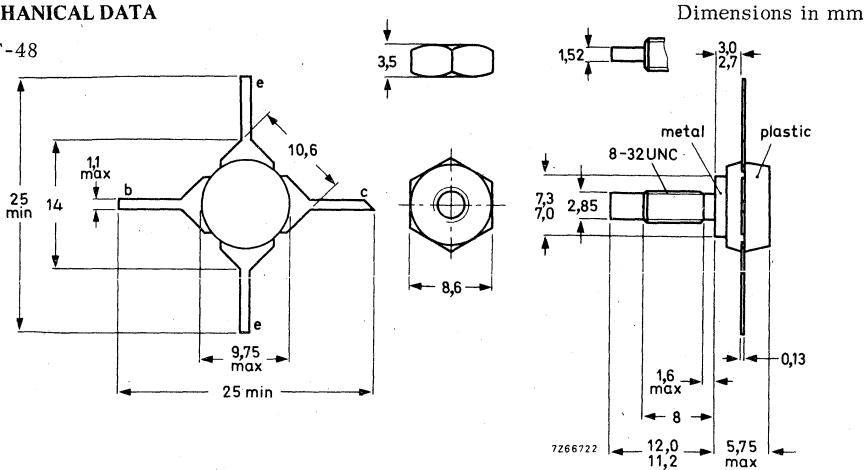

When locking is required an adhesive instead of a lock washer is preferred.

Torque on nut: min. 0,75 Nm
(7,5 kg cm)
max. 0,85 Nm
(8,5 kg cm)

Diameter of clearance hole in heatsink: max. 4,17 mm.

Mounting hole to have no burrs at either end. De-burring must leave surface flat; do not chamfer or countersink either end of hole.

RATINGS Limiting values in accordance with the Absolute Maximum System (IEC134)

Voltages

| | | | | | |
|--|------------|------|-----|---|----|
| Collector-base voltage (open emitter; peak value) | V_{CBOM} | max. | 40 | V | 1) |
| Collector-emitter voltage ($R_{BE} = 10 \Omega$; peak value) | V_{CERM} | max. | 40 | V | 2) |
| Collector-emitter voltage (open base) | V_{CEO} | max. | 25 | V | 2) |
| Emitter-base voltage (open collector) | V_{EBO} | max. | 3,5 | V | 3) |

Currents

| | | | | |
|--|----------|------|-----|----|
| Collector current (d. c.) | I_C | max. | 200 | mA |
| Collector current (peak value) $f > 1$ MHz | I_{CM} | max. | 500 | mA |

Power dissipation ($f > 1$ MHz; see SOAR)

| | | | | |
|---|-----------|------|-----|---|
| Total power dissipation up to $T_{mb} = 60^\circ C$ | P_{tot} | max. | 3,5 | W |
|---|-----------|------|-----|---|

Temperatures

| | | | |
|----------------------|-----------|-------------|----------------|
| Storage temperature | T_{stg} | -40 to +150 | $^\circ C$ |
| Junction temperature | T_j | max. | 150 $^\circ C$ |

THERMAL RESISTANCE

| | | | | |
|--------------------------------|---------------|---|-----|--------------|
| From junction to mounting base | $R_{th j-mb}$ | = | 25 | $^\circ C/W$ |
| From mounting base to heatsink | $R_{th mb-h}$ | = | 0,5 | $^\circ C/W$ |

1) at $I_C = 100 \mu A$.

2) at $I_C = 10$ mA.

3) at $I_E = 100 \mu A$.

CHARACTERISTICS

$T_j = 25\text{ }^\circ\text{C}$ unless otherwise specified

Collector cut-off current

$I_E = 0; V_{CB} = 20\text{ V}$

$I_{CBO} < 10\text{ }\mu\text{A}$

Saturation voltage

$I_C = 100\text{ mA}; I_B = 10\text{ mA}$

$V_{CEsat} < 0,75\text{ V}$

D. C. current gain

$I_C = 50\text{ mA}; V_{CE} = 5\text{ V}$

$h_{FE} > 25$

$I_C = 150\text{ mA}; V_{CE} = 5\text{ V}$

$h_{FE} > 25$

Collector capacitance at $f = 1\text{ MHz}$

$I_E = I_e = 0; V_{CB} = 20\text{ V}$

$C_c < 4,5\text{ pF}$

Feedback capacitance at $f = 1\text{ MHz}$

$I_C = 10\text{ mA}; V_{CE} = 20\text{ V}; T_{mb} = 25\text{ }^\circ\text{C}$

$C_{re} \text{ typ. } 1,7\text{ pF}$

Noise figure at $f = 200\text{ MHz}$

$I_C = 40\text{ mA}; V_{CE} = 20\text{ V}; R_S = 75\text{ }\Omega; T_{mb} = 25\text{ }^\circ\text{C}$

$F \text{ typ. } 6\text{ dB}$

Transition frequency at $f = 500\text{ MHz}$

$I_C = 15\text{ mA}; V_{CE} = 20\text{ V}$

$f_T \text{ typ. } 1000\text{ MHz}$

$I_C = 75\text{ mA}; V_{CE} = 20\text{ V}$

$f_T > 1200\text{ MHz}$

$I_C = 150\text{ mA}; V_{CE} = 20\text{ V}$

$f_T \text{ typ. } 1200\text{ MHz}$

Output power at $f = 200\text{ MHz}; T_{mb} = 25\text{ }^\circ\text{C}$

$I_C = 70\text{ mA}; V_{CE} = 20\text{ V}; \text{VSWR at output} < 2$
 $f_p = 202\text{ MHz}; f_q = 205\text{ MHz}; d_{im} = -30\text{ dB}$
 measured at $f(2q-p) = 208\text{ MHz}$ (channel 9)

$P_o > 130\text{ mW}$
 $\text{typ. } 150\text{ mW}$

Output power at $f = 800\text{ MHz}; T_{mb} = 25\text{ }^\circ\text{C}$

$I_C = 70\text{ mA}; V_{CE} = 20\text{ V}; \text{VSWR at output} < 2$
 $f_p = 798\text{ MHz}; f_q = 802\text{ MHz}; d_{im} = -30\text{ dB}$
 measured at $f(2q-p) = 806\text{ MHz}$ (channel 62)

$P_o > 70\text{ mW}$
 $\text{typ. } 90\text{ mW}$

Power gain (not neutralized) $T_{mb} = 25\text{ }^\circ\text{C}$

$I_C = 70\text{ mA}; V_{CE} = 20\text{ V}; f = 200\text{ MHz}$

$G_p > 15\text{ dB}$
 $\text{typ. } 16\text{ dB}$

$I_C = 70\text{ mA}; V_{CE} = 20\text{ V}; f = 800\text{ MHz}$

$G_p \text{ typ. } 6,5\text{ dB}$

CHARACTERISTICS (continued)

Intermodulation characteristics

1. Output power at $f = 200$ MHz; $T_{mb} = 25$ °C

$I_C = 70$ mA; $V_{CE} = 20$ V; VSWR at output < 2
 $f_p = 202$ MHz; $f_q = 205$ MHz; $d_{im} = -30$ dB
 measured at $f(2q-p) = 208$ MHz (channel 9)

Test circuit:

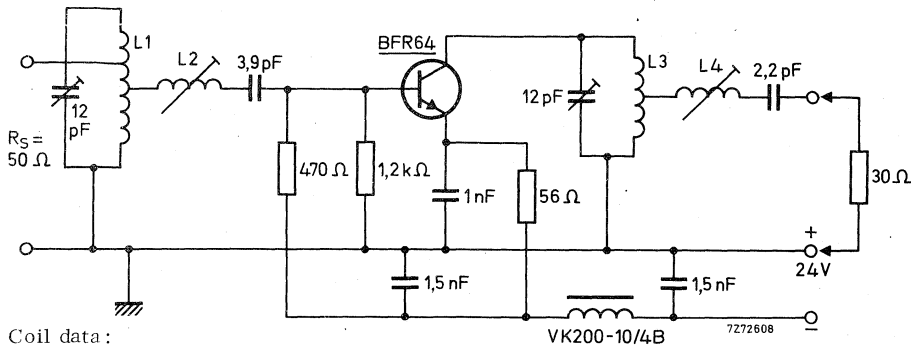

Coil data:

- L1 = 3 turns silver-plated Cu wire (1,4 mm); winding pitch 2,7 mm; int. dia. 8 mm; taps at 0,5 turn and 1,5 turns from earth.
- L2 = 5,5 turns silver-plated Cu wire (1,4 mm); winding pitch 2,2 mm; int. dia. 8 mm
- L3 = 3 turns silver-plated Cu wire (1,4 mm); winding pitch 3,3 mm; int. dia. 8 mm
- L4 = 5,5 turns silver-plated Cu wire (1,4 mm); winding pitch 2,2 mm; int. dia. 11 mm

CHARACTERISTICS (continued)**Basis of adjustment**

The intermodulation at an intermodulation distortion of -30 dB is caused by h. f. output current-voltage clipping.

The maximum undistorted output power is realized, if

- a. Current and voltage clipping take place concurrently.

This occurs if

$$R_L = \frac{V_{CE} - V_{CEK}}{I_C},$$

in which V_{CEK} is the high-frequency knee voltage.

- b. The h. f. collector current is as small as possible.

This is so if $-C_L = +C_{Oe}$.

in which C_{Oe} is the output capacitance of the transistor at short-circuited input.

For maximum output power at an intermodulation distortion of -30 dB, the (experimentally found) values of R_L and C_L are:

$R_L = 220 \Omega$; $C_L = -4 \text{ pF}$.

Adjustment procedure

1. Remove the transistor and connect a dummy consisting of a 220Ω resistor in parallel with a 4 pF capacitor between the collector and emitter connections of the output circuit.
2. Tune and match the output circuit for zero reflection at 205 MHz ($V_{SWR} = 1$). After this adjustment, no further change may be made in the output circuit.
3. Replace the dummy by the transistor. Tune and match the input circuit for maximum power gain and good band-pass curve.
The V_{SWR} of the output will then, in most cases, be ≤ 2 over the whole channel. Corrections can be made by tuning L_2 ; this will not disturb the band-pass curve.

CHARACTERISTICS (continued)

Intermodulation characteristics

2. Output power at $f = 800$ MHz; $T_{mb} = 25$ °C

$I_C = 70$ mA; $V_{CE} = 20$ V; VSWR at output < 2

$f_p = 798$ MHz; $f_q = 802$ MHz; $d_{im} = -30$ dB
measured at $f(2q-p) = 806$ MHz (channel 62)

Test circuit:

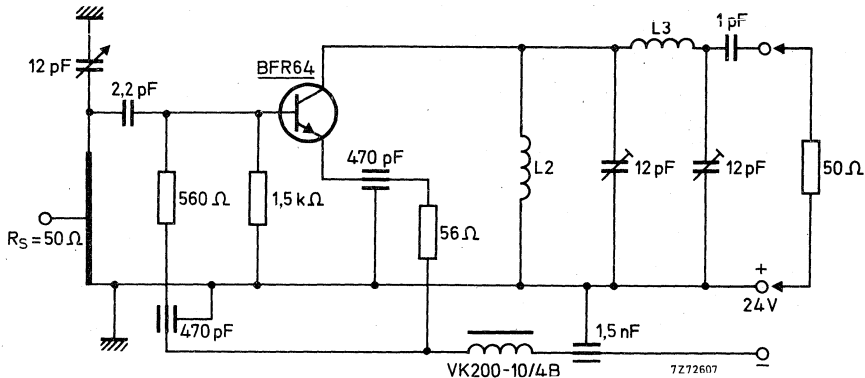

Coil data :

L1 = 25 mm x 7 mm x 0,85 mm silver-plated Cu strip

Tap of the input at 5 mm from earth.

L2 = 13 turns enamelled Cu wire (0,6 mm); int. dia. 8 mm

L3 = 1,5 turns Cu wire (1,3 mm); int. dia. 8 mm

Basis of adjustment

At 800 MHz no dummy can be used to adjust for optimum collector load because at these frequencies the impedance transformations of a dummy are too high. A small signal at the mid-channel frequency of 802 MHz is fed to the input and increased until clipping occurs; that is, until the output power no longer increases linearly with the input signal. This clipping can be eliminated by tuning the output circuit, thereby making the output power equal to

$$P_o = \frac{I_C(V_{CE} - V_{CEK})}{2} = 480 \text{ mW.}$$

The output circuit is adjusted for minimum intermodulation if the input signal is as small as possible at $P_o = 480$ mW. With this adjusting method, care must be taken that the transistor is not damaged by second breakdown (the voltage swing may not exceed the rated V_{CER} value). Therefore as soon as clipping occurs, the increase of the input signal should be stopped until the clipping has been eliminated. After this adjustment has been made no further change may be made in the output circuit. Adjust the input circuit for maximum power gain and good band-pass curve. The VSWR of the output is then ≤ 2 over the whole channel.

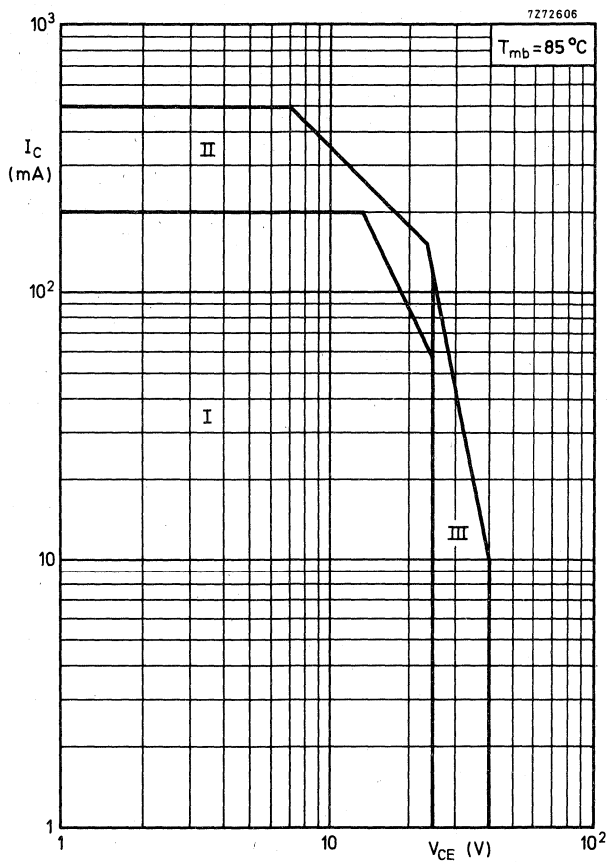

Safe Operating Area with the transistor forward biased

- I Region of permissible d. c. operation
- II Permissible extension for repetitive pulsed operation; $f > 1$ MHz
- III Repetitive pulse operation in this region is allowable, provided $R_{BE} < 10 \Omega$ and $f > 1$ MHz

BFR64

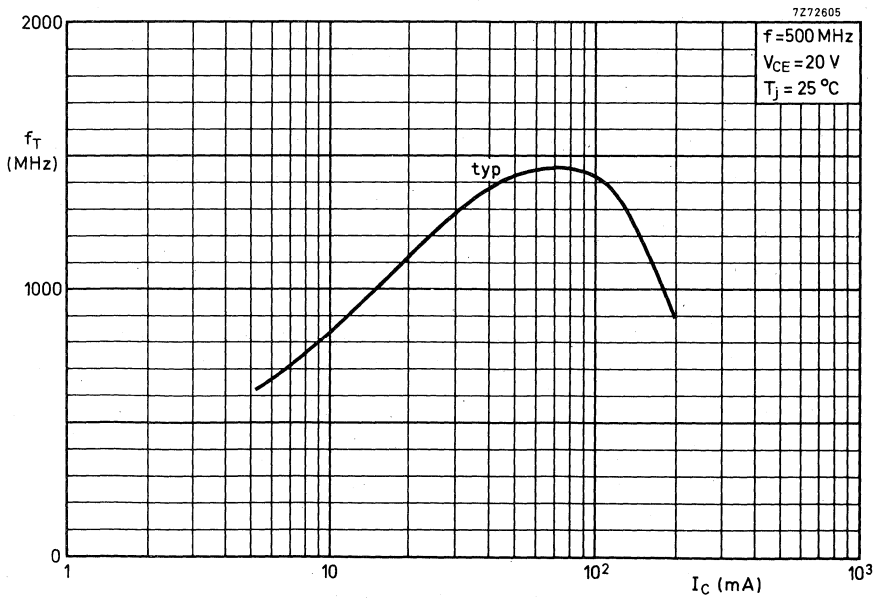
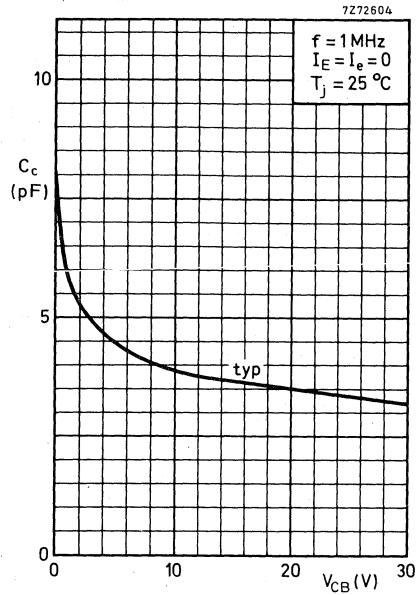
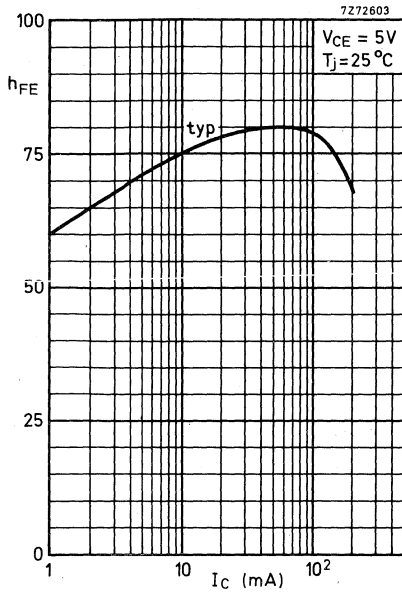

SILICON PLANAR EPITAXIAL TRANSISTOR

N-P-N multi-emitter silicon transistor in a capstan envelope. The transistor has extremely good intermodulation properties and high power gain.

The device is primarily intended for channel amplifiers in aerial amplifier systems as well as other applications where an excellent f_T linearity and higher signal handling capabilities than available in existing devices are required.

QUICK REFERENCE DATA

| | | | |
|---|----------------|------|----------|
| Collector-base voltage (open emitter; peak value) | V_{CBOM} | max. | 40 V |
| Collector-emitter voltage (open base) | V_{CEO} | max. | 25 V |
| Collector current (peak value) | I_{CM} | max. | 1000 mA |
| Junction temperature | T_j | max. | 200 °C |
| Thermal resistance from junction to mounting base | $R_{th\ j-mb}$ | = | 15 °C/W |
| Transition frequency at $f = 500$ MHz $I_C = 200$ mA; $V_{CE} = 20$ V | f_T | > | 1200 MHz |
| Output power at $f = 200$ MHz $I_C = 200$ mA; $V_{CE} = 20$ V; $d_{im} = -30$ dB | P_o | typ. | 450 mW |
| Power gain at $f = 200$ MHz $I_C = 200$ mA; $V_{CE} = 20$ V | G_p | typ. | 19 dB |

MECHANICAL DATA

SOT-48

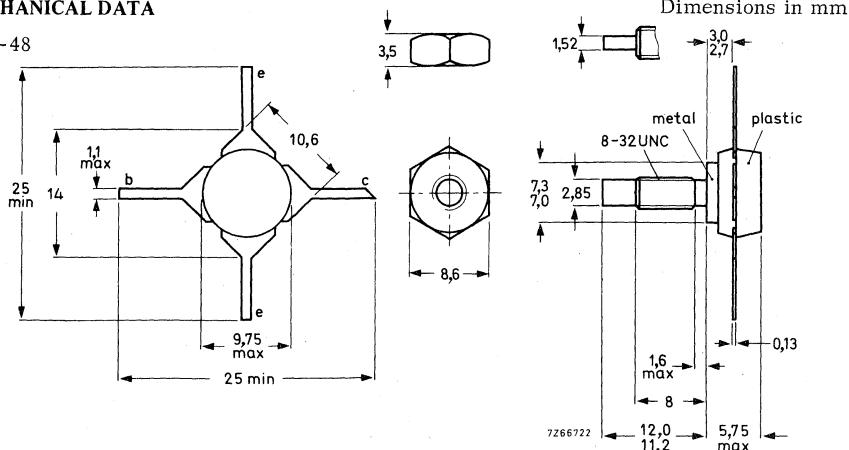

When locking is required an adhesive instead of a lock washer is preferred.

Torque on nut: min. 0,75 Nm
(7,5 kg cm)
0,85 Nm
(8,5 kg cm)

Diameter of clearance hole in heatsink: max. 4,17 mm.

Mounting hole to have no burrs at either end. De-burring must leave surface flat; do not chamfer or countersink either end of hole.

RATINGS Limiting values in accordance with the Absolute Maximum System (IEC 134)Voltages

| | | | | |
|--|------------|------|-----|---|
| Collector-base voltage (open emitter; peak value) | V_{CBOM} | max. | 40 | V |
| Collector-emitter voltage ($R_{BE} = 10 \Omega$; peak value) | V_{CERM} | max. | 40 | V |
| Collector-emitter voltage (open base) | V_{CEO} | max. | 25 | V |
| Emitter-base voltage (open collector) | V_{EBO} | max. | 3.5 | V |

Currents

| | | | | |
|--|----------|------|------|----|
| Collector current (d. c.) | I_C | max. | 400 | mA |
| Collector current (peak value) $f > 1$ MHz | I_{CM} | max. | 1000 | mA |

Power dissipationTotal power dissipation up to $T_{mb} = 125^\circ\text{C}$

See also page 6

| | | | |
|-----------|------|---|---|
| P_{tot} | max. | 5 | W |
|-----------|------|---|---|

Temperatures

| | | | |
|----------------------|-----------|-------------|------------------|
| Storage temperature | T_{stg} | -65 to +200 | $^\circ\text{C}$ |
| Junction temperature | T_j | max. 200 | $^\circ\text{C}$ |

THERMAL RESISTANCE

| | | | | |
|--------------------------------|----------------|---|-----|---------------------------|
| From junction to mounting base | $R_{th\ j-mb}$ | = | 15 | $^\circ\text{C}/\text{W}$ |
| From mounting base to heatsink | $R_{th\ mb-h}$ | = | 0.5 | $^\circ\text{C}/\text{W}$ |

CHARACTERISTICS

 $T_j = 25^\circ\text{C}$ unless otherwise specifiedBreakdown voltages

| | | | | |
|---|---------------|---|----|---|
| Collector-base voltage open emitter, $I_C = 1\text{ mA}$ | $V_{(BR)CBO}$ | > | 40 | V |
|---|---------------|---|----|---|

| | | | | |
|--|---------------|---|----|---|
| Collector-emitter voltage $R_{BE} = 10\ \Omega$, $I_C = 5\text{ mA}$ | $V_{(BR)CER}$ | > | 40 | V |
| open base, $I_C = 5\text{ mA}$ | $V_{(BR)CEO}$ | > | 25 | V |

| | | | | |
|---|---------------|---|-----|---|
| Emitter-base voltage open collector; $I_E = 1\text{ mA}$ | $V_{(BR)EBO}$ | > | 3.5 | V |
|---|---------------|---|-----|---|

Collector cut-off current

| | | | | |
|------------------------------------|-----------|---|-----|---------------|
| $I_E = 0$; $V_{CB} = 20\text{ V}$ | I_{CBO} | < | 100 | μA |
|------------------------------------|-----------|---|-----|---------------|

Saturation voltage

| | | | | |
|--|-------------|---|------|---|
| $I_C = 200\text{ mA}$; $I_B = 20\text{ mA}$ | V_{CEsat} | < | 0.75 | V |
|--|-------------|---|------|---|

D. C. current gain

| | | | | |
|--|----------|---|----|--|
| $I_C = 200\text{ mA}$; $V_{CE} = 20\text{ V}$ | h_{FE} | > | 30 | |
| $I_C = 400\text{ mA}$; $V_{CE} = 20\text{ V}$ | h_{FE} | > | 20 | |

Collector capacitance at $f = 1\text{ MHz}$

| | | | | |
|--|-------|---|----|----|
| $I_E = I_e = 0$; $V_{CB} = 20\text{ V}$ | C_C | < | 10 | pF |
|--|-------|---|----|----|

Feedback capacitance at $f = 1\text{ MHz}$

| | | | | |
|---|----------|------|-----|----|
| $I_C = 10\text{ mA}$; $V_{CE} = 20\text{ V}$; $T_{mb} = 25^\circ\text{C}$ | C_{re} | typ. | 3.5 | pF |
|---|----------|------|-----|----|

Collector-stud capacitance

| | | | | |
|--|----------|------|---|----|
| | C_{cs} | typ. | 2 | pF |
|--|----------|------|---|----|

Transition frequency at $f = 500\text{ MHz}$

| | | | | |
|--|-------|---|------|-----|
| $I_C = 200\text{ mA}$; $V_{CE} = 20\text{ V}$ | f_T | > | 1200 | MHz |
| $I_C = 400\text{ mA}$; $V_{CE} = 20\text{ V}$ | f_T | > | 1000 | MHz |

Output power at $f = 200\text{ MHz}$; $T_{mb} = 25^\circ\text{C}$

| | | | | |
|---|-------|------|-----|----|
| $I_C = 200\text{ mA}$; $V_{CE} = 20\text{ V}$; V.S.W.R. at output < 2 $f_p = 202\text{ MHz}$; $f_q = 205\text{ MHz}$; $d_{im} = -30\text{ dB}$ measured at $f(2q-p) = 208\text{ MHz}$ (channel 9) | P_o | typ. | 450 | mW |
|---|-------|------|-----|----|

Power gain (not neutralized) $T_{mb} = 25^\circ\text{C}$

| | | | | |
|---|-------|------|-----|----|
| $I_C = 200\text{ mA}$; $V_{CE} = 20\text{ V}$; $f = 200\text{ MHz}$ | G_p | > | 15 | dB |
| | | typ. | 19 | dB |
| $I_C = 200\text{ mA}$; $V_{CE} = 20\text{ V}$; $f = 800\text{ MHz}$ | G_p | typ. | 4.5 | dB |

CHARACTERISTICS (continued)

Intermodulation characteristics

1. Output power at $f = 200$ MHz; $T_{mb} = 25$ °C

$I_C = 200$ mA; $V_{CE} = 20$ V; V. S. W. R. at output < 2

$f_p = 202$ MHz; $f_q = 205$ MHz; $d_{im} = -30$ dB

measured at $f(2q-p) = 208$ MHz (channel 9)

Test circuit:

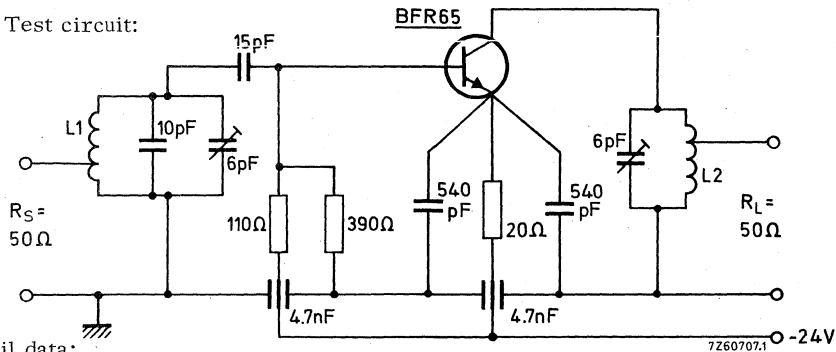

Coil data:

L1 = 1 turn silver plated Cu wire (1.4 mm); int. diam. 8 mm; tap at 0.75 turn from earth.

L2 = 3 turns silver plated Cu wire (1.4 mm); int. diam. 8 mm; winding pitch 2.7 mm; tap at 2.5 turns from earth.

CHARACTERISTICS (continued)

Basis of adjustment

The intermodulation at an intermodulation distortion of -30 dB is caused by h. f. output current - voltage clipping.

The maximum undistorted output power is realised, if

- a. Current and voltage clipping take place concurrently.

This occurs if

$$R_L = \frac{V_{CE} - V_{CEK}}{I_C},$$

in which V_{CEK} is the high frequency knee voltage.

- b. The h. f. collector current is as small as possible.

This is so if $-C_L = +C_{oe}$,

in which C_{oe} is the output capacitance of the transistor at short circuited input.

For maximum output power at an intermodulation distortion of -30 dB, the (experimentally found) values of R_L and C_L are:

$R_L = 91 \Omega$; $C_L = -6.8 \text{ pF}$.

Adjustment procedure

1. Remove the transistor and connect a dummy consisting of a 91Ω resistor in parallel with a 6.8 pF capacitor between the collector and emitter connections of the output circuit.
2. Tune and match the output circuit for zero reflection at 205 MHz (V.S.W.R. = 1) After this adjustment, no further change may be made in the output circuit.
3. Replace the dummy by the transistor. Tune and match the input circuit for maximum power gain and good band pass curve.
The V.S.W.R. of the output will then, in most cases, be ≤ 2 over the whole channel.

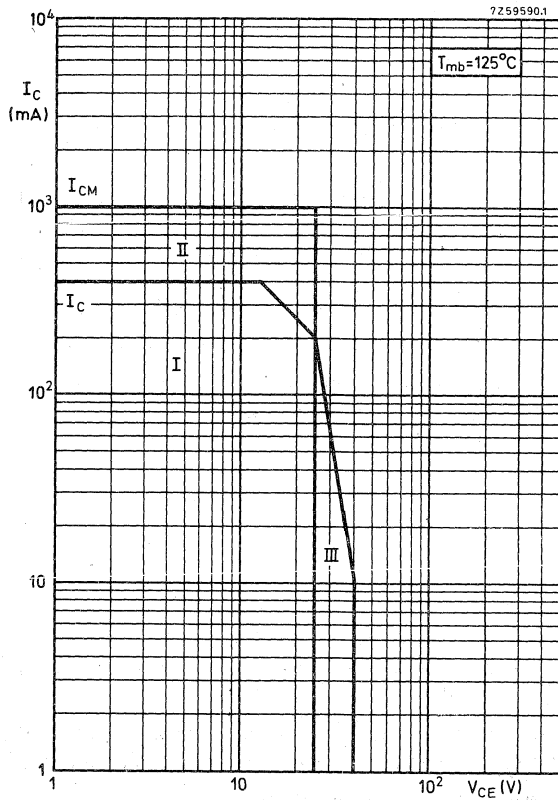

Safe Operating Area with the transistor forward biased

- I Region of permissible d.c. operation
- II Permissible extension for repetitive pulsed operation; $f > 1\text{MHz}$
- III Repetitive pulsed operation in this region is allowable, provided $f > 1\text{MHz}$; $R_{BE} < 10 \Omega$

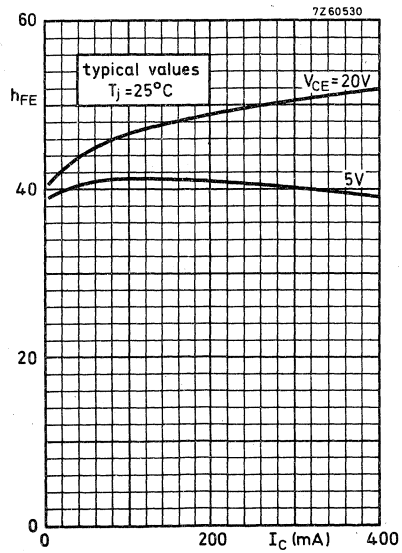
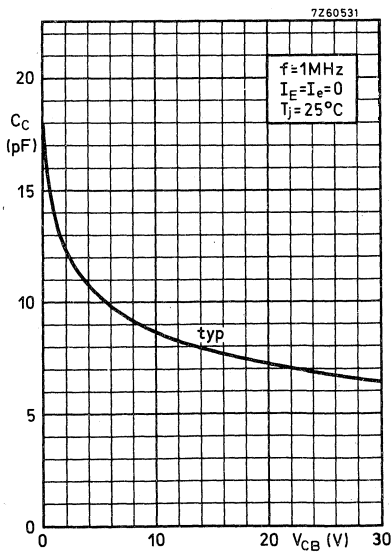
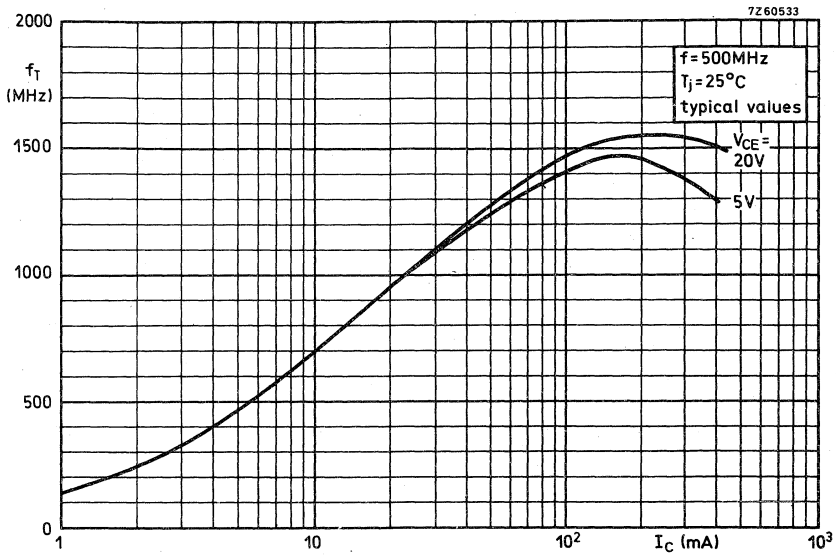

SILICON PLANAR EPITAXIAL TRANSISTOR

N-P-N transistor in a subminiature plastic transfer-moulded T-package.

It is primarily intended for use in u.h.f. and microwave amplifiers such as in aerial amplifiers, radar systems, oscilloscopes, spectrum analysers etc.

The transistor features low intermodulation distortion and high power gain; thanks to its very high transition frequency, it also has excellent wideband properties and low noise up to high frequencies.

QUICK REFERENCE DATA

| | | | | |
|---|-----------|------|------|------------------|
| Collector-base voltage (open emitter) | V_{CBO} | max. | 20 | V |
| Collector-emitter voltage (open base) | V_{CEO} | max. | 15 | V |
| Collector current (d. c.) | I_C | max. | 25 | mA |
| Total power dissipation up to $T_{amb} = 60\text{ }^\circ\text{C}$ | P_{tot} | max. | 180 | mW |
| Junction temperature | T_j | max. | 150 | $^\circ\text{C}$ |
| Transition frequency at $f = 500\text{ MHz}$ $I_C = 14\text{ mA}; V_{CE} = 10\text{ V}$ | f_T | typ. | 5 | GHz |
| Feedback capacitance at $f = 1\text{ MHz}$ $I_C = 2\text{ mA}; V_{CE} = 10\text{ V}; T_{amb} = 25\text{ }^\circ\text{C}$ | C_{re} | typ. | 0,4 | pF |
| Noise figure at optimum source impedance $I_C = 2\text{ mA}; V_{CE} = 10\text{ V}; f = 500\text{ MHz}; T_{amb} = 25\text{ }^\circ\text{C}$ | | typ. | 2,4 | dB |
| Max. unilateral power gain (see page 3) $I_C = 14\text{ mA}; V_{CE} = 10\text{ V}; f = 500\text{ MHz}; T_{amb} = 25\text{ }^\circ\text{C}$ | GUM | typ. | 19,5 | dB |
| Intermodulation distortion at $T_{amb} = 25\text{ }^\circ\text{C}$ $I_C = 14\text{ mA}; V_{CE} = 10\text{ V}; R_L = 75\text{ }\Omega; V_o = 150\text{ mV}$ | | | | |
| $f(p + q - r) = 493,25\text{ MHz}$ (see page 4) | d_{im} | typ. | -60 | dB |

MECHANICAL DATA

SOT -37

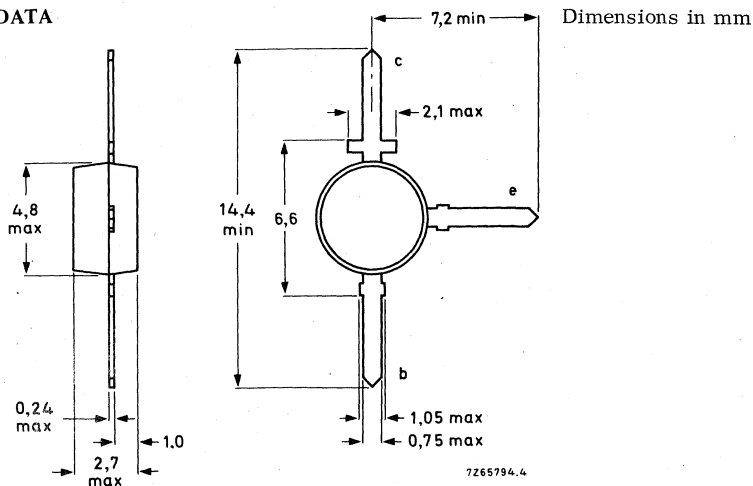

RATINGS Limiting values in accordance with the Absolute Maximum System (IEC134)

Voltages

| | | | | |
|---------------------------------------|-----------|------|-----|---|
| Collector-base voltage (open emitter) | V_{CBO} | max. | 20 | V |
| Collector-emitter voltage (open base) | V_{CEO} | max. | 15 | V |
| Emitter-base voltage (open collector) | V_{EBO} | max. | 2,0 | V |

Current

| | | | | |
|---------------------------|-------|------|----|----|
| Collector current (d. c.) | I_C | max. | 25 | mA |
|---------------------------|-------|------|----|----|

Power dissipation

| | | | | |
|--|-----------|------|-----|----|
| Total power dissipation up to $T_{amb} = 60\text{ }^\circ\text{C}$ | P_{tot} | max. | 180 | mW |
|--|-----------|------|-----|----|

Temperatures

| | | | |
|----------------------|-----------|-------------|------------------|
| Storage temperature | T_{stg} | -65 to +150 | $^\circ\text{C}$ |
| Junction temperature | T_j | max. 150 | $^\circ\text{C}$ |

THERMAL RESISTANCE

From junction to ambient in free air

mounted on a glass-fibre print *)
of 40 mm x 25 mm x 1 mm

$$R_{th\ j-a} = 0,5\text{ }^\circ\text{C/mW}$$

*) Requirements for glas-fibre print

(dimensions in mm)

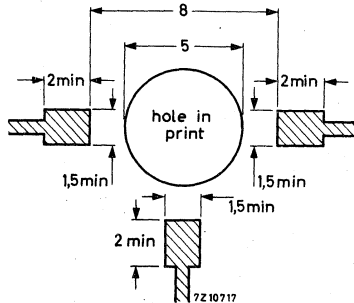

CHARACTERISTICS

$T_j = 25\text{ }^\circ\text{C}$ unless otherwise specified

Collector cut-off current

$I_E = 0; V_{CB} = 10\text{ V}$

$I_{CBO} < 50\text{ nA}$

D. C. current gain ¹⁾

$I_C = 14\text{ mA}; V_{CE} = 10\text{ V}$

$h_{FE} > 25$
typ. 50

Transition frequency at $f = 500\text{ MHz}$ ¹⁾

$I_C = 14\text{ mA}; V_{CE} = 10\text{ V}$

f_T typ. 5 GHz

Collector capacitance at $f = 1\text{ MHz}$

$I_E = I_e = 0; V_{CB} = 10\text{ V}$

C_c typ. 0,5 pF

Emitter capacitance at $f = 1\text{ MHz}$

$I_C = I_c = 0; V_{EB} = 0,5\text{ V}$

C_e typ. 0,8 pF

Feedback capacitance at $f = 1\text{ MHz}$

$I_C = 2\text{ mA}; V_{CE} = 10\text{ V}; T_{amb} = 25\text{ }^\circ\text{C}$

C_{re} typ. 0,4 pF

Noise figure at optimum source impedance

$I_C = 2\text{ mA}; V_{CE} = 10\text{ V}; f = 500\text{ MHz}; T_{amb} = 25\text{ }^\circ\text{C}$

F typ. 2,4 dB

Max. unilateral power gain (s_{re} assumed to be zero)

$$G_{UM} \text{ (in dB)} = 10 \log \frac{|s_{fe}|^2}{(1 - |s_{ie}|^2)(1 - |s_{oe}|^2)}$$

$I_C = 14\text{ mA}; V_{CE} = 10\text{ V}; f = 500\text{ MHz}; T_{amb} = 25\text{ }^\circ\text{C}$

G_{UM} typ. 19,5 dB

¹⁾ Measured under pulse conditions.

CHARACTERISTICS (continued)

Intermodulation distortion at $T_{amb} = 25^{\circ}\text{C}$

$I_C = 14\text{ mA}$; $V_{CE} = 10\text{ V}$; $R_L = 75\ \Omega$; V. S. W. R. < 2

$V_p = V_o = 150\text{ mV}$ at $f_p = 495, 25\text{ MHz}$

$V_q = V_o - 6\text{ dB}$ at $f_q = 503, 25\text{ MHz}$

$V_r = V_o - 6\text{ dB}$ at $f_r = 505, 25\text{ MHz}$

Measured at $f_{(p+q-r)} = 493, 25\text{ MHz}$

dim typ. -60 dB

Intermodulation test circuit:

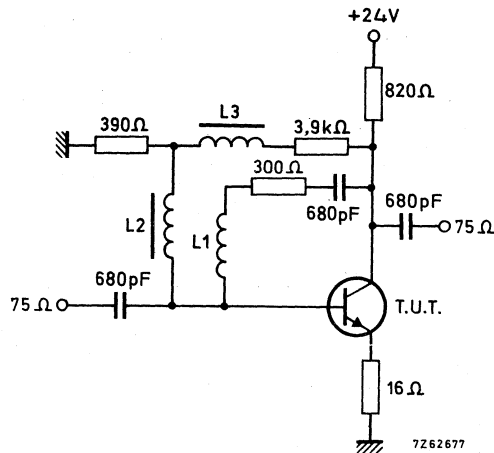

L1 = 4 turns Cu wire (0,35 mm); winding pitch 1 mm; int. diam. 4 mm
 L2 and L3 5μH (code number: 3122 108 20150)

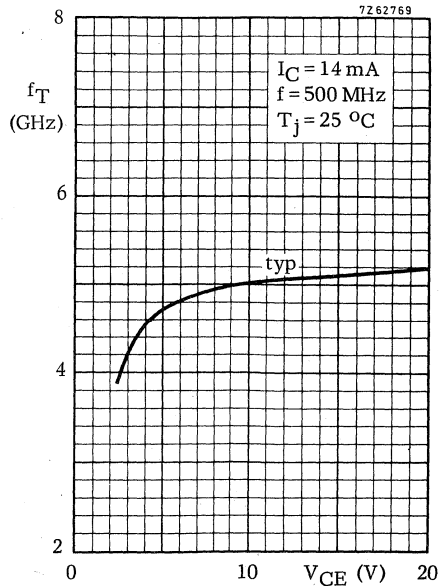
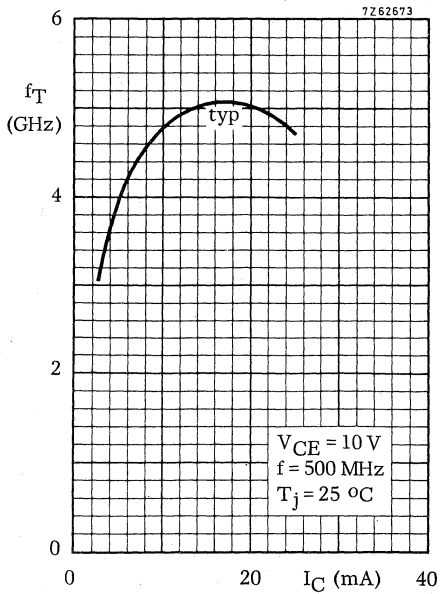
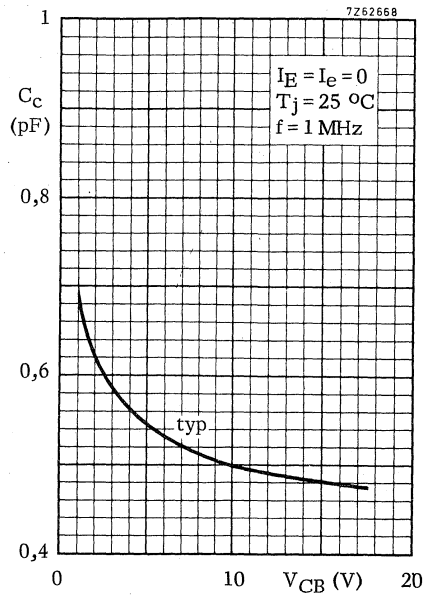
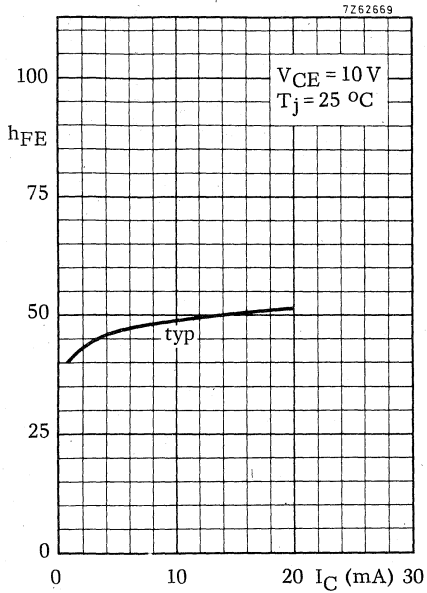

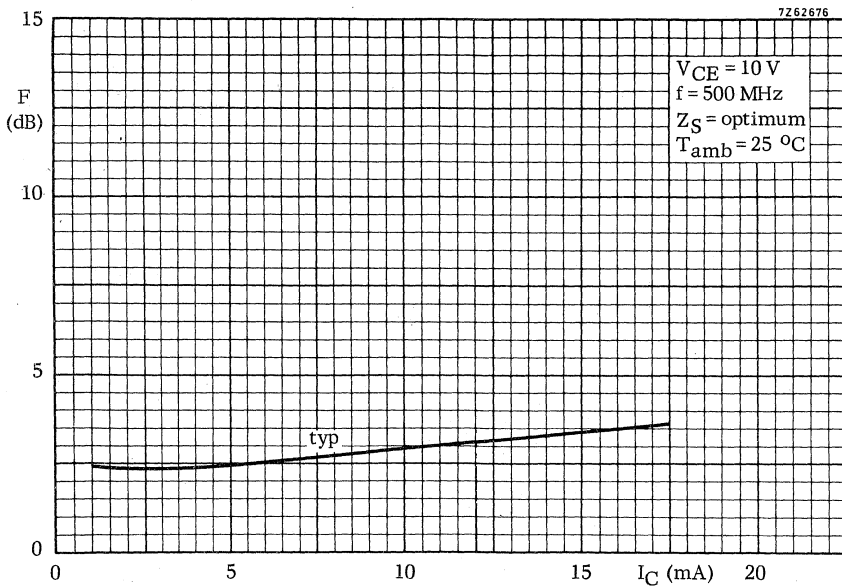
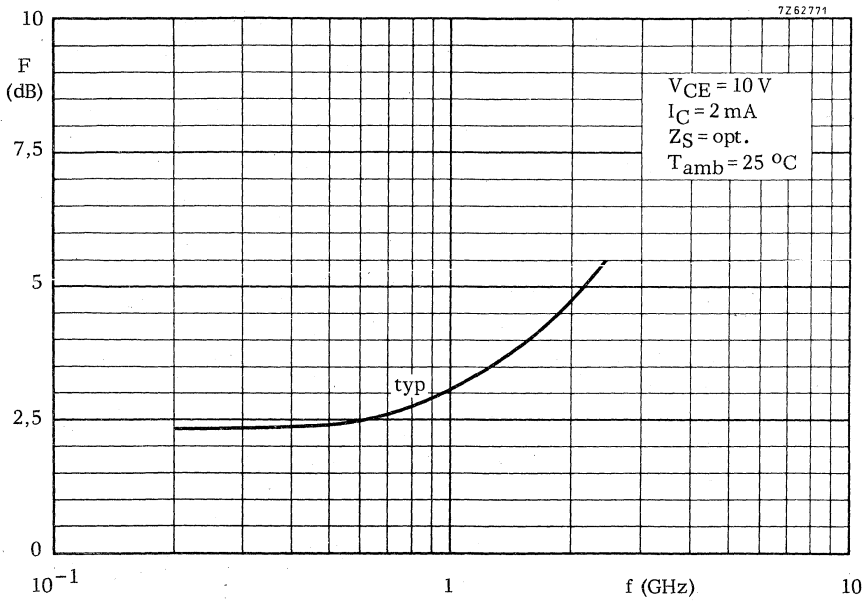

circles of constant noise figure

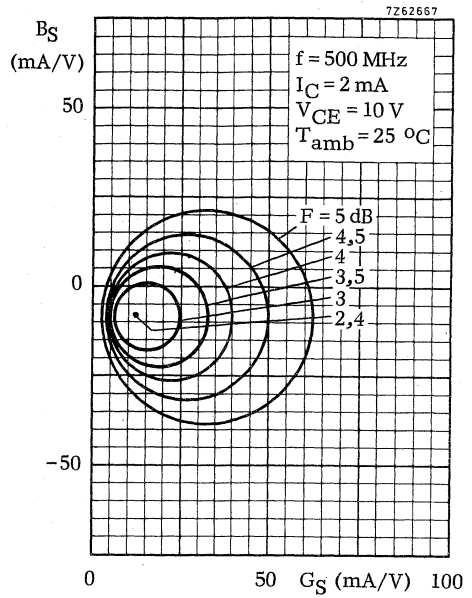
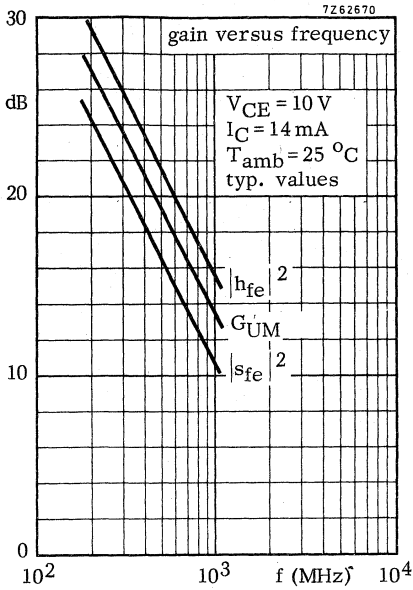

$V_{CE} = 10\text{ V}$
 $I_C = 14\text{ mA}$
 $T_{amb} = 25\text{ }^\circ\text{C}$

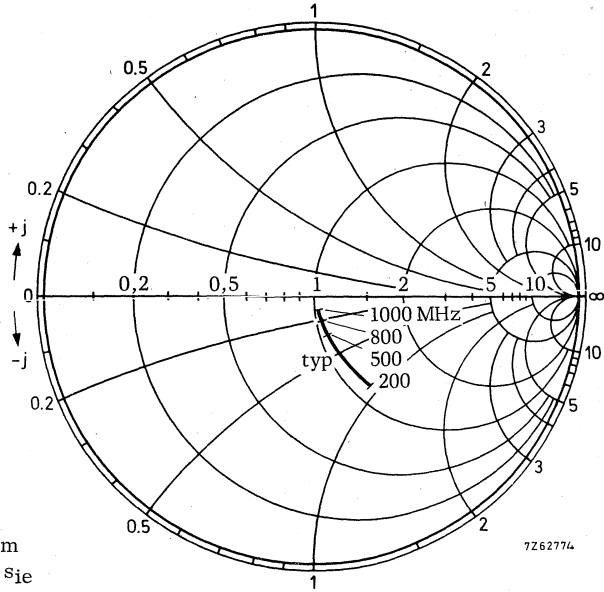

Input impedance derived from
input reflection coefficient s_{ie}
coordinates in ohm x 50

$V_{CE} = 10\text{ V}$
 $I_C = 14\text{ mA}$
 $T_{amb} = 25\text{ }^\circ\text{C}$

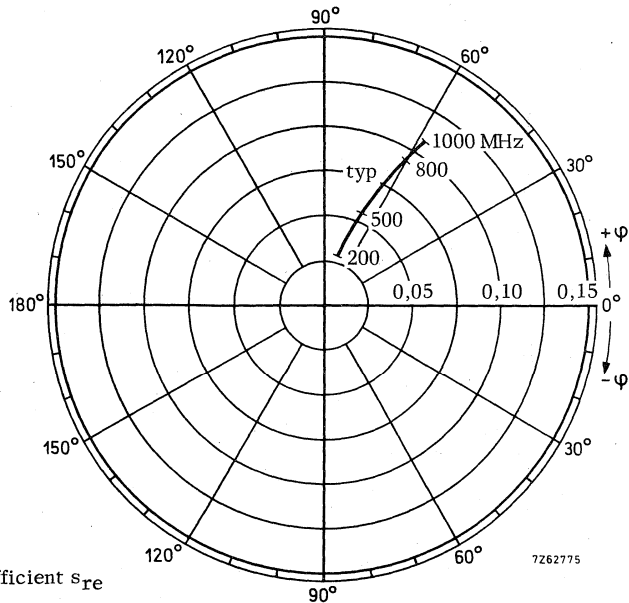

Reverse transmission coefficient s_{re}

$V_{CE} = 10\text{ V}$
 $I_C = 14\text{ mA}$
 $T_{amb} = 25\text{ }^\circ\text{C}$

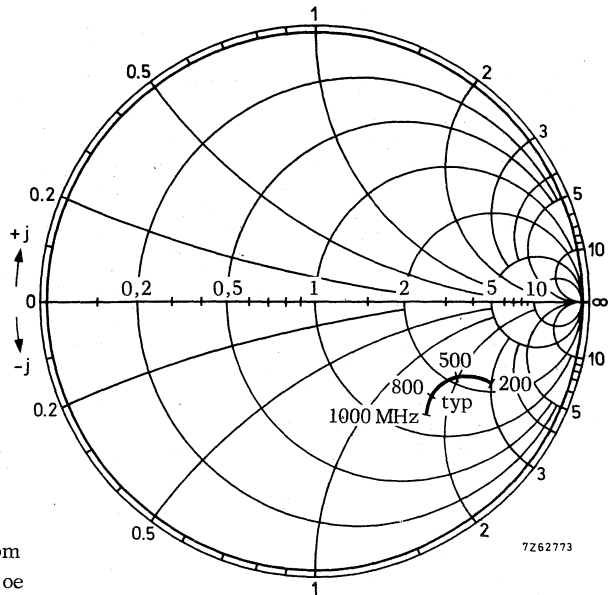

Output impedance derived from
 output reflection coefficient s_{oe}
 coordinates in ohm x 50

$V_{CE} = 10\text{ V}$
 $I_C = 14\text{ mA}$
 $T_{amb} = 25\text{ }^\circ\text{C}$

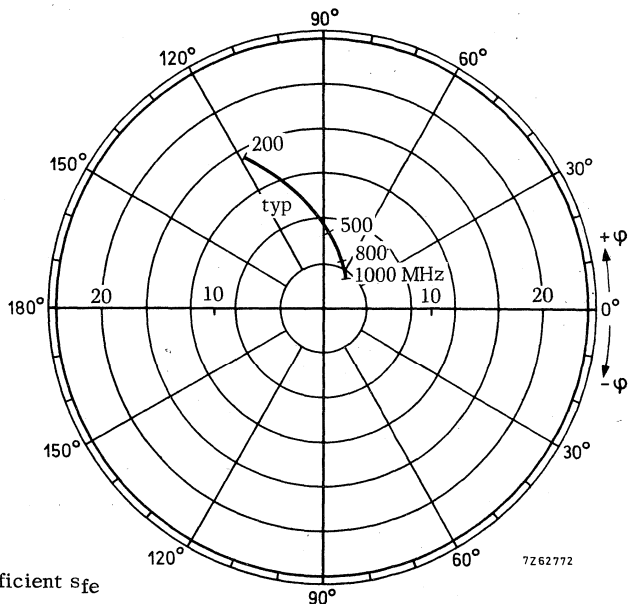

Forward transmission coefficient s_{fe}

SILICON PLANAR EPITAXIAL TRANSISTOR

N-P-N transistor in a subminiature plastic transfer-moulded T-package.

It is primarily intended for use in u.h.f. and microwave amplifiers such as in aerial amplifiers, radar systems, oscilloscopes, spectrum analysers etc.

The transistor features very low intermodulation distortion and high power gain; thanks to its very high transition frequency, it also has excellent wideband properties and low noise up to high frequencies.

QUICK REFERENCE DATA

| | | | | |
|---|-----------|------|------|------------------|
| Collector-base voltage (open emitter) | V_{CBO} | max. | 15 | V |
| Collector-emitter voltage (open base) | V_{CEO} | max. | 12 | V |
| Collector current (d. c.) | I_C | max. | 35 | mA |
| Total power dissipation up to $T_{amb} = 60^\circ\text{C}$ | P_{tot} | max. | 180 | mW |
| Junction temperature | T_j | max. | 150 | $^\circ\text{C}$ |
| Transition frequency at $f = 500\text{ MHz}$ $I_C = 30\text{ mA}; V_{CE} = 5\text{ V}$ | f_T | typ. | 5 | GHz |
| Feedback capacitance at $f = 1\text{ MHz}$ $I_C = 2\text{ mA}; V_{CE} = 5\text{ V}; T_{amb} = 25^\circ\text{C}$ | C_{re} | typ. | 0,8 | pF |
| Noise figure at optimum source impedance $I_C = 2\text{ mA}; V_{CE} = 5\text{ V}; f = 500\text{ MHz}; T_{amb} = 25^\circ\text{C}$ | F | typ. | 1,9 | dB |
| Max. unilateral power gain (see page 3) $I_C = 30\text{ mA}; V_{CE} = 5\text{ V}; f = 500\text{ MHz}; T_{amb} = 25^\circ\text{C}$ | G_{UM} | typ. | 16,5 | dB |
| Intermodulation distortion at $T_{amb} = 25^\circ\text{C}$ $I_C = 30\text{ mA}; V_{CE} = 5\text{ V}; R_L = 75\ \Omega; V_o = 300\text{ mV}$ $f(p + q - r) = 493,25\text{ MHz}$ (see page 4) | d_{im} | typ. | -60 | dB |

MECHANICAL DATA

SOT-37

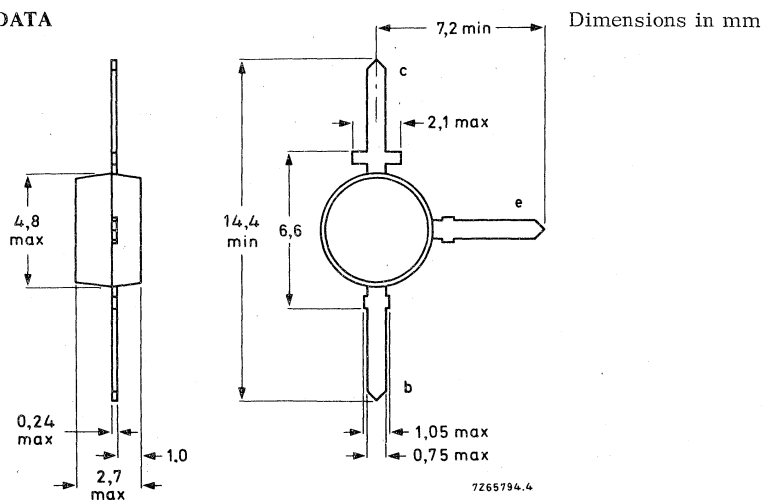

RATINGS Limiting values in accordance with the Absolute Maximum System (IEC134)

Voltages

| | | | | |
|---------------------------------------|-----------|------|-----|---|
| Collector-base voltage (open emitter) | V_{CBO} | max. | 15 | V |
| Collector-emitter voltage (open base) | V_{CEO} | max. | 12 | V |
| Emitter-base voltage (open collector) | V_{EBO} | max. | 2,0 | V |

Current

| | | | | |
|---------------------------|-------|------|----|----|
| Collector current (d. c.) | I_C | max. | 35 | mA |
|---------------------------|-------|------|----|----|

Power dissipation

| | | | | |
|--|-----------|------|-----|----|
| Total power dissipation up to $T_{amb} = 60\text{ }^{\circ}\text{C}$ | P_{tot} | max. | 180 | mW |
|--|-----------|------|-----|----|

Temperatures

| | | | |
|----------------------|-----------|-------------|--------------------|
| Storage temperature | T_{stg} | -65 to +150 | $^{\circ}\text{C}$ |
| Junction temperature | T_j | max. 150 | $^{\circ}\text{C}$ |

THERMAL RESISTANCE

From junction to ambient in free air

mounted on a glass-fibre print *)
of 40 mm x 25 mm x 1 mm

$$R_{th\ j-a} = 0,5\text{ }^{\circ}\text{C/mW}$$

*) Requirements for glass-fibre print

(dimensions in mm)

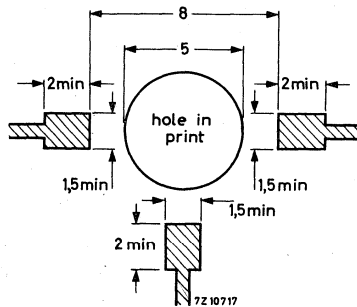

CHARACTERISTICS

$T_j = 25\text{ }^\circ\text{C}$ unless otherwise specified

Collector cut-off current

$I_E = 0; V_{CB} = 5\text{ V}$ $I_{CBO} < 50\text{ nA}$

D. C. current gain ¹⁾

$I_C = 30\text{ mA}; V_{CE} = 5\text{ V}$ $h_{FE} > 25$
 $\text{typ. } 50$

Transition frequency at $f = 500\text{ MHz}$ ¹⁾

$I_C = 30\text{ mA}; V_{CE} = 5\text{ V}$ $f_T \text{ typ. } 5\text{ GHz}$

Collector capacitance at $f = 1\text{ MHz}$

$I_E = I_e = 0; V_{CB} = 10\text{ V}$ $C_C \text{ typ. } 0,7\text{ pF}$

Emitter capacitance at $f = 1\text{ MHz}$

$I_C = I_c = 0; V_{EB} = 0,5\text{ V}$ $C_e \text{ typ. } 1,8\text{ pF}$

Feedback capacitance at $f = 1\text{ MHz}$

$I_C = 2\text{ mA}; V_{CE} = 5\text{ V}; T_{amb} = 25\text{ }^\circ\text{C}$ $C_{re} \text{ typ. } 0,8\text{ pF}$

Noise figure at optimum source impedance

$I_C = 2\text{ mA}; V_{CE} = 5\text{ V}; f = 500\text{ MHz}; T_{amb} = 25\text{ }^\circ\text{C}$ $F \text{ typ. } 1,9\text{ dB}$

Max. unilateral power gain (s_{re} assumed to be zero)

$$G_{UM} \text{ (in dB)} = 10 \log \frac{|s_{fe}|^2}{(1 - |s_{ie}|^2)(1 - |s_{oe}|^2)}$$

$I_C = 30\text{ mA}; V_{CE} = 5\text{ V}; f = 500\text{ MHz}; T_{amb} = 25\text{ }^\circ\text{C}$ $G_{UM} \text{ typ. } 16,5\text{ dB}$

¹⁾ Measured under pulse conditions.

CHARACTERISTICS (continued)

Intermodulation distortion at $T_{amb} = 25\text{ }^{\circ}\text{C}$

$I_C = 30\text{ mA}$; $V_{CE} = 5\text{ V}$; $R_L = 75\text{ }\Omega$; V.S.W.R. < 2

$V_p = V_o = 300\text{ mV}$ at $f_p = 495,25\text{ MHz}$

$V_q = V_o - 6\text{ dB}$ at $f_q = 503,25\text{ MHz}$

$V_r = V_o - 6\text{ dB}$ at $f_r = 505,25\text{ MHz}$

Measured at $f_{(p+q-r)} = 493,25\text{ MHz}$

dim typ. -60 dB

Intermodulation test circuit:

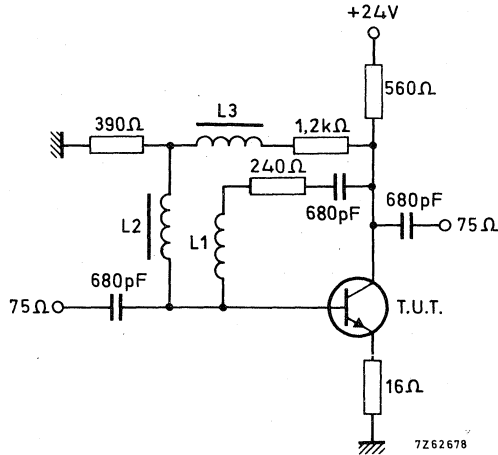

L1 = 4 turns Cu wire (0,35); winding pitch 1 mm; int. diam. 4 mm

L2 and L3 5 μH (code number: 3122 108 20150)

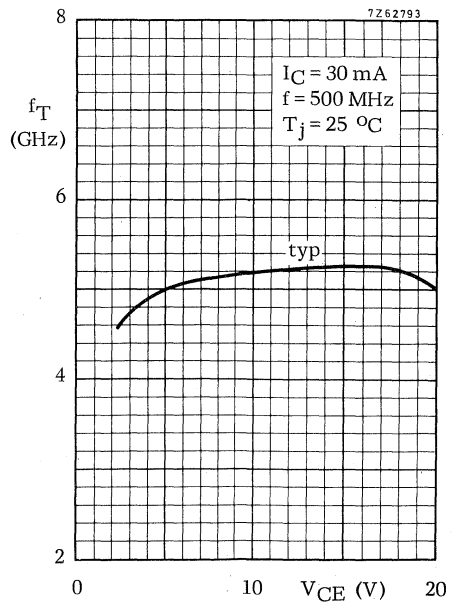
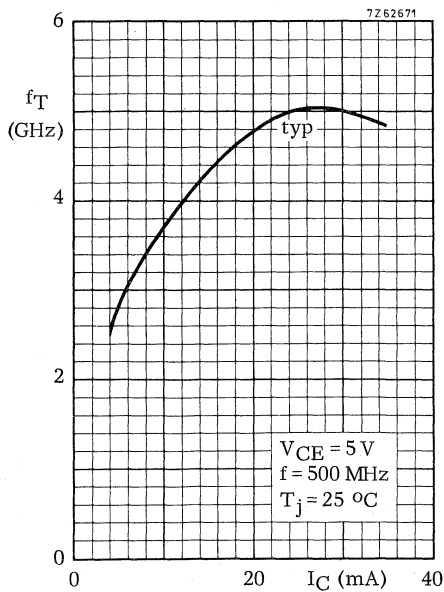
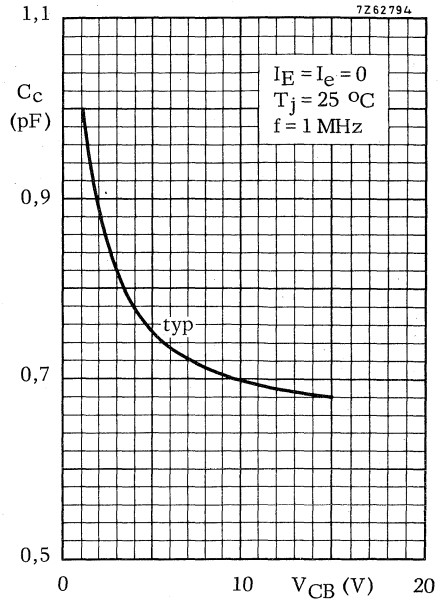
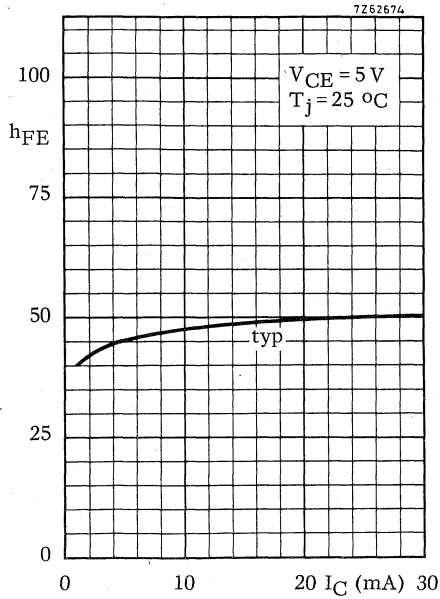

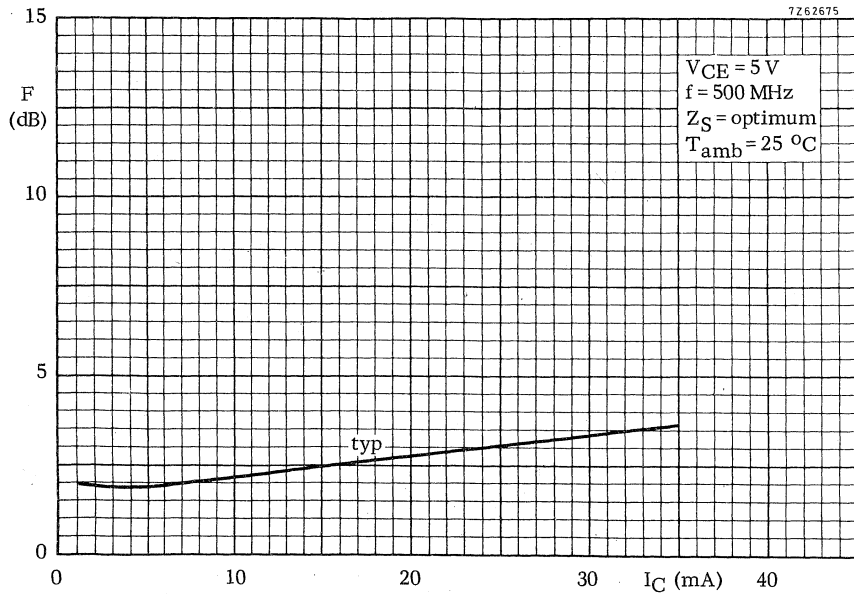
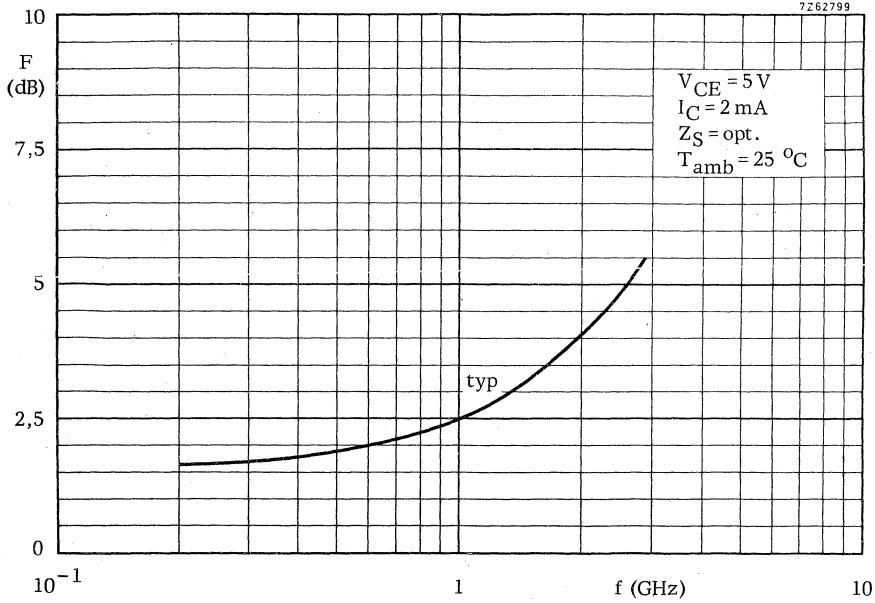

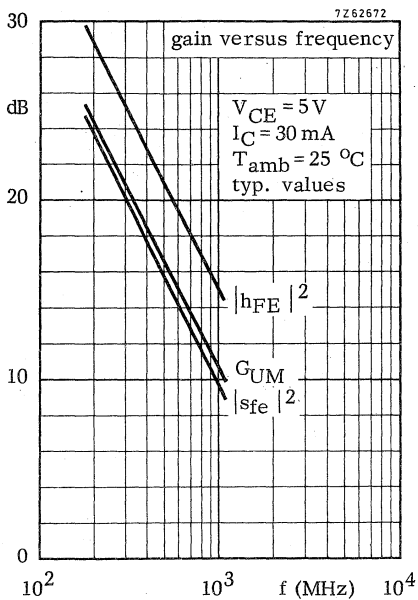

circles of constant noise figure

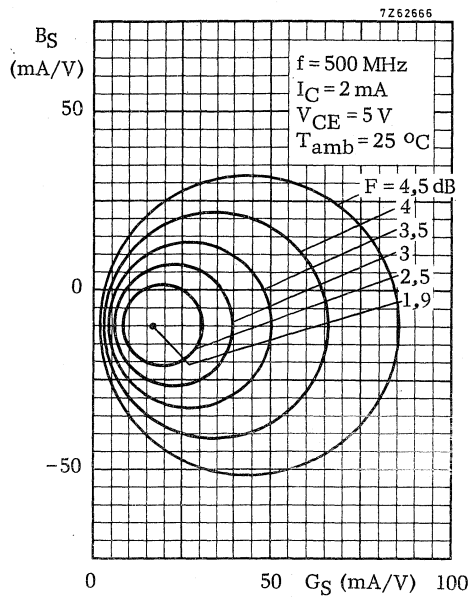

$V_{CE} = 5\text{ V}$
 $I_C = 30\text{ mA}$
 $T_{amb} = 25\text{ }^\circ\text{C}$

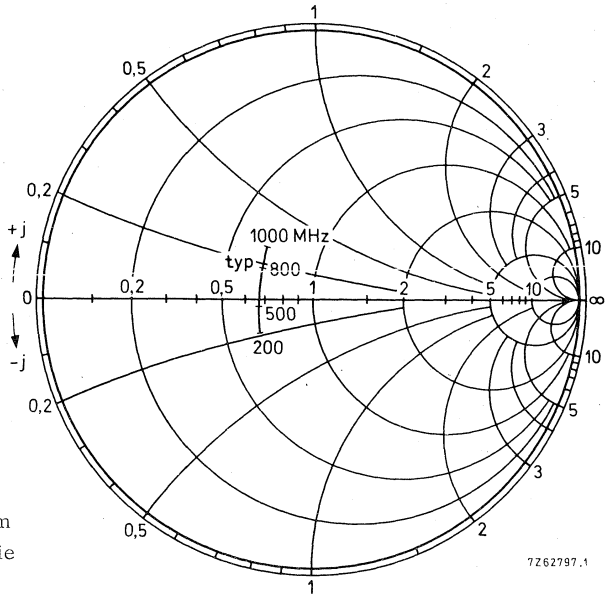

$V_{CE} = 5\text{ V}$
 $I_C = 30\text{ mA}$
 $T_{amb} = 25\text{ }^\circ\text{C}$

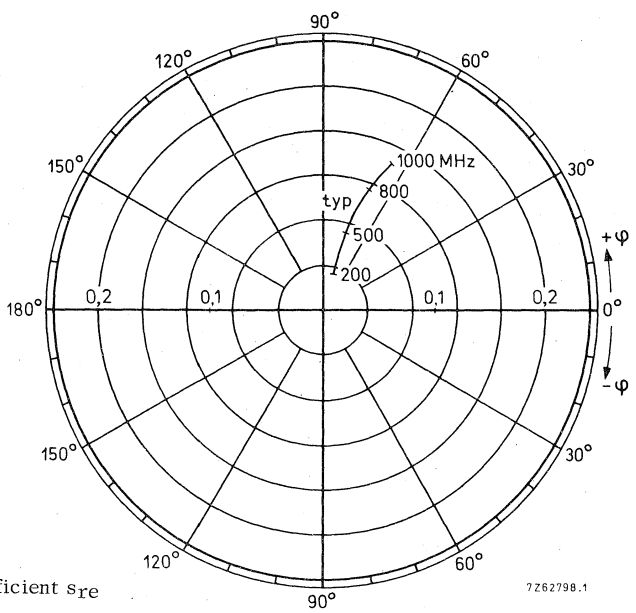

$V_{CE} = 5\text{ V}$
 $I_C = 30\text{ mA}$
 $T_{amb} = 25\text{ }^\circ\text{C}$

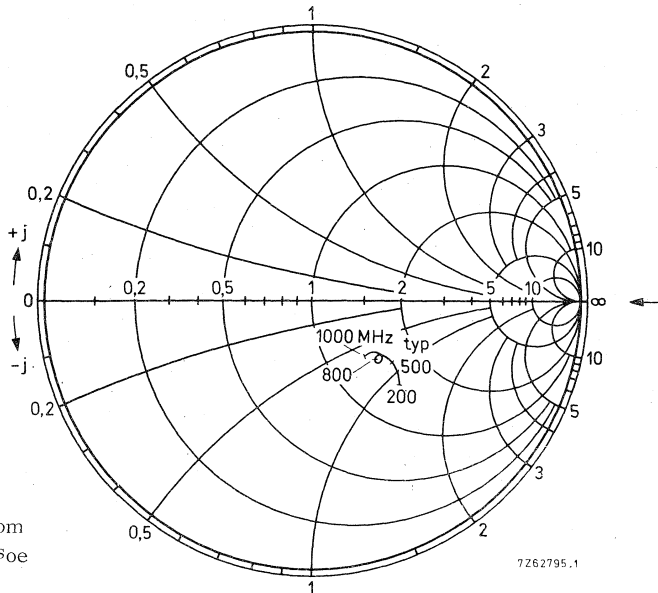

$V_{CE} = 5\text{ V}$
 $I_C = 30\text{ mA}$
 $T_{amb} = 25\text{ }^\circ\text{C}$

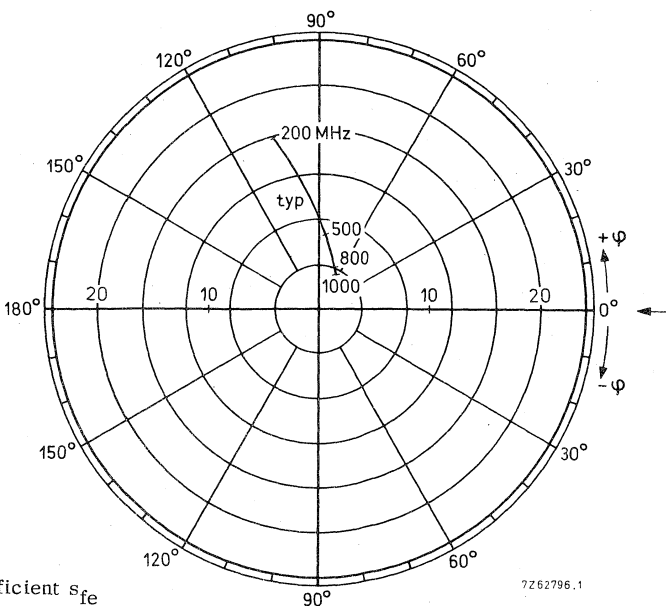

SILICON PLANAR EPITAXIAL TRANSISTOR

N-P-N resistance-stabilized transistor in a SOT-48 capstan envelope featuring extremely low cross modulation, intermodulation and second harmonic distortion. Thanks to its high transition frequency it has a high power gain in conjunction with good wideband properties and low noise up to high frequencies.

It is primarily intended for CATV and MATV applications.

| QUICK REFERENCE DATA | | | |
|---|-----------|------|----------------------|
| Collector-base voltage (open emitter) | V_{CBO} | max. | 30 V |
| Collector-emitter voltage (open base) | V_{CEO} | max. | 25 V |
| Collector current (d. c.) | I_C | max. | 150 mA |
| Total power dissipation up to $T_h = 145\text{ }^\circ\text{C}$; $f > 1\text{ MHz}$ | P_{tot} | max. | 3,5 W |
| Junction temperature | T_j | max. | 200 $^\circ\text{C}$ |
| Transition frequency at $f = 500\text{ MHz}$ $I_C = 90\text{ mA}$; $V_{CE} = 20\text{ V}$ | f_T | typ. | 3,5 GHz |
| Cross modulation distortion (channel 13) $I_C = 90\text{ mA}$; $V_{CE} = 20\text{ V}$; $V_o = 48\text{ dBmV}$ | d_{cm} | typ. | -61 dB |
| | | < | -57 dB |
| $I_C = 90\text{ mA}$; $V_{CE} = 20\text{ V}$; $V_o = 32\text{ dBmV}$ | d_{cm} | typ. | -93 dB |
| | | < | -89 dB |
| Intermodulation distortion at $f_{(p+q-r)} = 194, 25\text{ MHz}$ $I_C = 90\text{ mA}$; $V_{CE} = 20\text{ V}$; $V_o = 60\text{ dBmV}$ | d_{im} | typ. | -63 dB |
| Broadband power gain $I_C = 90\text{ mA}$; $V_{CE} = 20\text{ V}$ | G_p | > | 10 dB |
| | | typ. | 11 dB |
| Noise figure at $f = 200\text{ MHz}$ $I_C = 90\text{ mA}$; $V_{CE} = 20\text{ V}$ | F | typ. | 8 dB |
| | | < | 10 dB |
| 2 nd harmonic distortion at $f_p + f_q = 210\text{ MHz}$ $I_C = 90\text{ mA}$; $V_{CE} = 20\text{ V}$; $V_o = 48\text{ dBmV}$ | d_2 | < | -56 dB |

MECHANICAL DATA (see page 2)

MECHANICAL DATA

SOT-48

Dimensions in mm

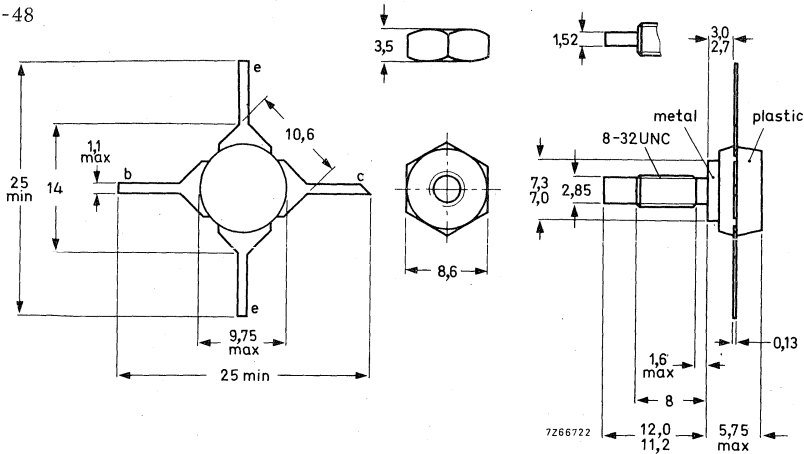

When locking is required an adhesive instead of a lock washer is preferred.

Torque on nut: min. 0,75 Nm
(7,5 kg cm)
max. 0,85 Nm
(8,5 kg cm)

Diameter of clearance hole in heatsink: max. 4,17 mm.
Mounting hole to have no burrs at either end.
De-burring must leave surface flat; do not chamfer or countersink either end of hole.

RATINGS Limiting values in accordance with the Absolute Maximum System (IEC134)

Voltages

| | | | |
|--|-----------|------|------|
| Collector-base voltage (open emitter) | V_{CB0} | max. | 30 V |
| Collector-emitter voltage ($R_{BE} = 10 \Omega$) | V_{CER} | max. | 35 V |
| Collector-emitter voltage (open base) | V_{CEO} | max. | 25 V |
| Emitter-base voltage (open collector) | V_{EBO} | max. | 3 V |

Currents

| | | | |
|---|----------|------|--------|
| Collector current (d.c.) | I_C | max. | 150 mA |
| Collector current (peak value); $f > 1$ MHz | I_{CM} | max. | 300 mA |

Power dissipation

| | | | |
|--|-----------|------|-------|
| Total power dissipation (d.c.) up to $T_h = 160 \text{ }^\circ\text{C}$ | P_{tot} | max. | 2,5 W |
| Total power dissipation up to $T_h = 145 \text{ }^\circ\text{C}$; $f > 1$ MHz | P_{tot} | max. | 3,5 W |

Temperatures

| | | |
|----------------------|-----------|------------------------------|
| Storage temperature | T_{stg} | -65 to +200 $^\circ\text{C}$ |
| Junction temperature | T_j | max. 200 $^\circ\text{C}$ |

THERMAL RESISTANCE

| | | | |
|--------------------------------|---------------|---|------------------------|
| From junction to mounting base | $R_{th j-mb}$ | = | 15 $^\circ\text{C/W}$ |
| From mounting base to heatsink | $R_{th mb-h}$ | = | 0,6 $^\circ\text{C/W}$ |

CHARACTERISTICS

$T_j = 25\text{ }^\circ\text{C}$ unless otherwise specified

Collector cut-off current

$I_E = 0; V_{CB} = 20\text{ V}$ $I_{CBO} < 50\text{ }\mu\text{A}$

D.C. current gain

$I_C = 50\text{ mA}; V_{CE} = 20\text{ V}$ $h_{FE} > 30$ 1)

$I_C = 150\text{ mA}; V_{CE} = 20\text{ V}$ $h_{FE} > 30$ 1)

Transition frequency at $f = 500\text{ MHz}$

$I_C = 90\text{ mA}; V_{CE} = 20\text{ V}$ f_T typ. 3,5 GHz 1)

$I_C = 150\text{ mA}; V_{CE} = 20\text{ V}$ f_T typ. 3,5 GHz 1)

Collector capacitance at $f = 1\text{ MHz}$

$I_E = I_c = 0 ; V_{CB} = 20\text{ V}$ C_c typ. 3,5 pF

Emitter capacitance at $f = 1\text{ MHz}$

$I_C = I_c = 0 ; V_{EB} = 0,5\text{ V}$ C_e typ. 12 pF

Feedback capacitance at $f = 1\text{ MHz}$

$I_C = 10\text{ mA}; V_{CE} = 20\text{ V}$ C_{re} typ. 1,3 pF

Collector-stud capacitance at $f = 1\text{ MHz}$

C_{cs} typ. 2 pF

Noise figure at optimum source impedance

$I_C = 90\text{ mA}; V_{CE} = 20\text{ V}; f = 500\text{ MHz}; T_{amb} = 25\text{ }^\circ\text{C}$ F typ. 5 dB 1)

Max. unilateral power gain (s_{re} assumed to be zero)

$$G_{UM} \text{ (in dB)} = 10 \log \frac{|s_{fe}|^2}{(1 - |s_{ie}|^2)(1 - |s_{oe}|^2)}$$

$I_C = 90\text{ mA}; V_{CE} = 20\text{ V}; f = 500\text{ MHz}; T_{amb} = 25\text{ }^\circ\text{C}$ G_{UM} typ. 13,5 dB

1) Measured under pulse conditions.

CHARACTERISTICS (continued)

Intermodulation distortion at $T_{amb} = 25\text{ }^{\circ}\text{C}$

$I_C = 90\text{ mA}$; $V_{CE} = 20\text{ V}$; $R_L = 75\text{ }\Omega$

$V_p = V_o = 700\text{ mV}$ at $f_p = 495,25\text{ MHz}$

$V_q = V_o -6\text{ dB}$ at $f_q = 503,25\text{ MHz}$

$V_r = V_o -6\text{ dB}$ at $f_r = 505,25\text{ MHz}$

Measured at $f_{(p+q-r)} = 493,25\text{ MHz}$

d_{im} typ. -60 dB

MATV test circuit

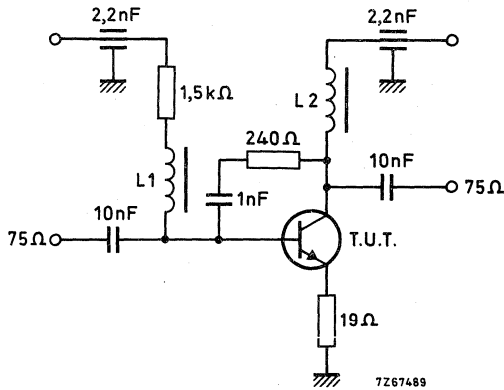

$L1 = L2 = 5\text{ }\mu\text{H}$ ferroxcube coil (code number: 3122 108 20153)

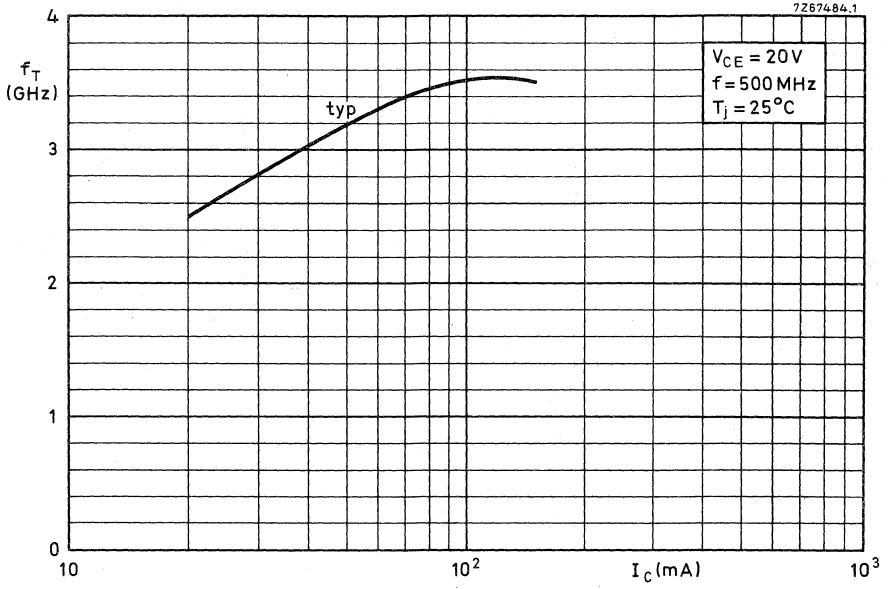

BFR94

$V_{CE} = 20 \text{ V}$
 $I_C = 90 \text{ mA}$
 $T_{amb} = 25 \text{ }^\circ\text{C}$

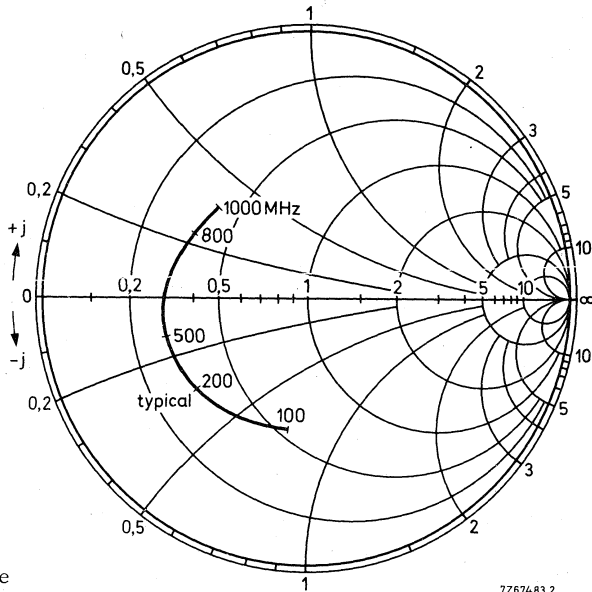

$V_{CE} = 20 \text{ V}$
 $I_C = 90 \text{ mA}$
 $T_{amb} = 25 \text{ }^\circ\text{C}$

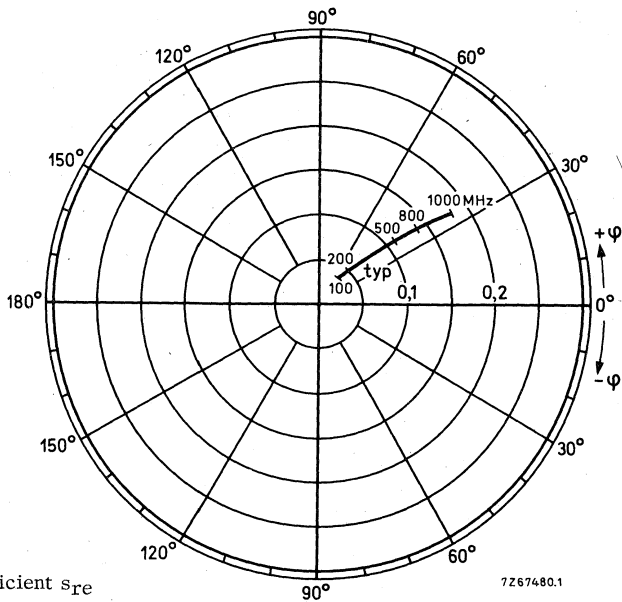

$V_{CE} = 20 \text{ V}$
 $I_C = 90 \text{ mA}$
 $T_{amb} = 25 \text{ }^\circ\text{C}$

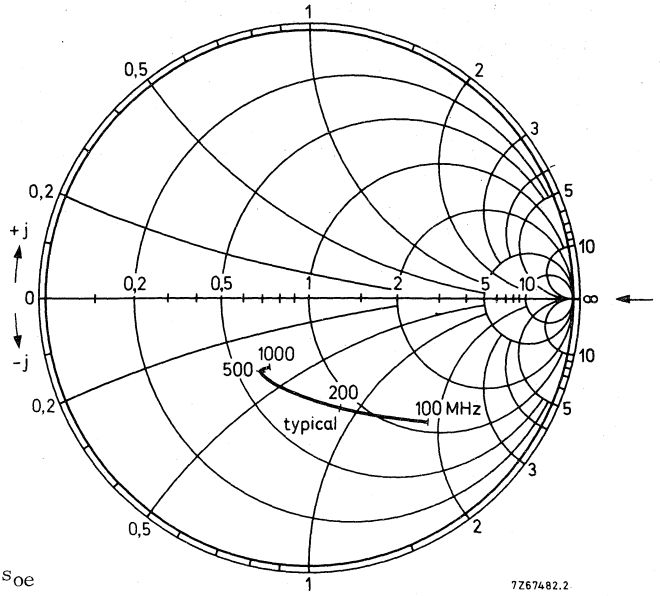

$V_{CE} = 20 \text{ V}$
 $I_C = 90 \text{ mA}$
 $T_{amb} = 25 \text{ }^\circ\text{C}$

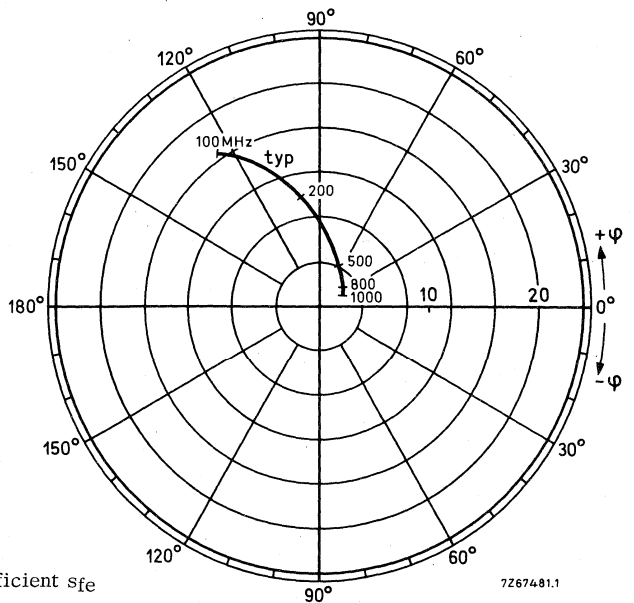

APPLICATION INFORMATION (see page 9)

$T_{amb} = 25\text{ }^{\circ}\text{C}$ unless otherwise specified

Cross modulation distortion (channel 13) 1)

| | | | | |
|--|----------|------|-----|----|
| $I_C = 90\text{ mA}; V_{CE} = 20\text{ V}; V_O = 48\text{ dBmV}$ | d_{cm} | typ. | -61 | dB |
| | | < | -57 | dB |
| $I_C = 90\text{ mA}; V_{CE} = 20\text{ V}; V_O = 32\text{ dBmV}$ | d_{cm} | typ. | -93 | dB |
| | | < | -89 | dB |

Intermodulation distortion

$I_C = 90\text{ mA}; V_{CE} = 20\text{ V}; R_L = 75\text{ }\Omega$

$V_p = V_O = 60\text{ dBmV}$ at $f_p = 196,25\text{ MHz}$

$V_q = V_O - 6\text{ dB}$ at $f_q = 203,25\text{ MHz}$

$V_r = V_O - 6\text{ dB}$ at $f_r = 205,25\text{ MHz}$

Measured at $f_{(p+q-r)} = 194,25\text{ MHz}$

| | | | |
|----------|------|-----|----|
| d_{im} | typ. | -63 | dB |
|----------|------|-----|----|

Broadband power gain

$I_C = 90\text{ mA}; V_{CE} = 20\text{ V}$

| | | | |
|-------|------|----|----|
| G_p | > | 10 | dB |
| | typ. | 11 | dB |

Noise figure

$I_C = 90\text{ mA}; V_{CE} = 20\text{ V}; f = 200\text{ MHz}$

| | | | |
|---|------|----|----|
| F | typ. | 8 | dB |
| | < | 10 | dB |

2nd harmonic distortion

$I_C = 90\text{ mA}; V_{CE} = 20\text{ V}$

$f_p = 66\text{ MHz}; f_q = 144\text{ MHz}; f_p + f_q = 210\text{ MHz}; V_O = 48\text{ dBmV}$

| | | | |
|-------|---|-----|----|
| d_2 | < | -56 | dB |
|-------|---|-----|----|

1) In 12-channel measuring equipment; channel 13 unmodulated.

V_O = output level/signal, according to NCTA measuring standard.

APPLICATION INFORMATION (continued)

CATV test circuit

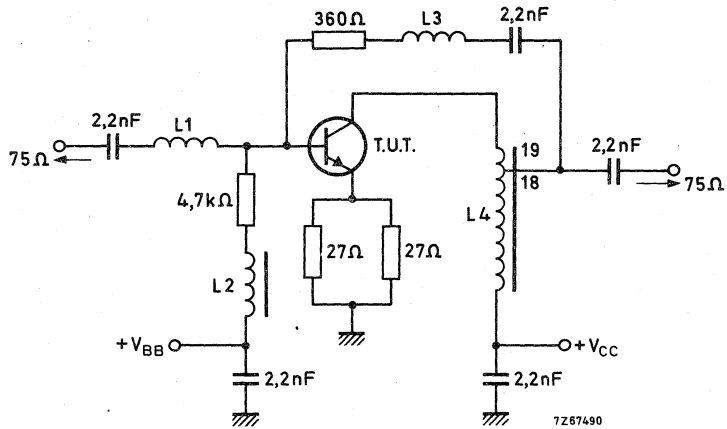

Frequency range 40 to 300 MHz (flatness gain $\pm 0,2$ dB)

Return losses input and output < -16 dB

Power gain G_p typ. 11 dB

L1 = 2 turns closely wound enamelled Cu wire (0,7 mm); int. diam. 3 mm

L2 = 5 μ H ferroxcube coil (code number 3122 108 20153)

L3 = 5 turns closely wound enamelled Cu wire (0,7 mm); int. diam. 4,7 mm

L4 = 19 turns enamelled Cu wire (0,3 mm) on ferroxcube core (code no. 4322 020 91001)

APPLICATION INFORMATION (continued)

7267487

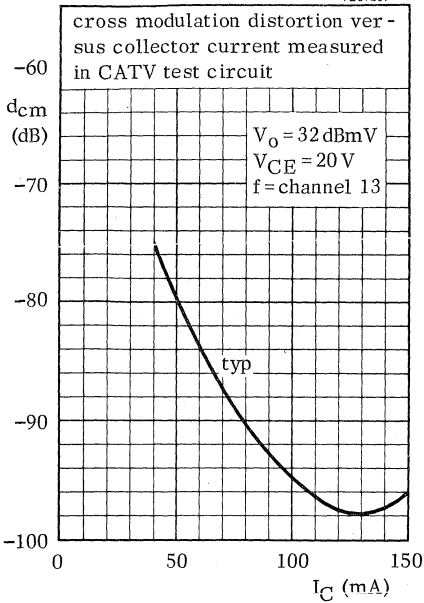

7267486

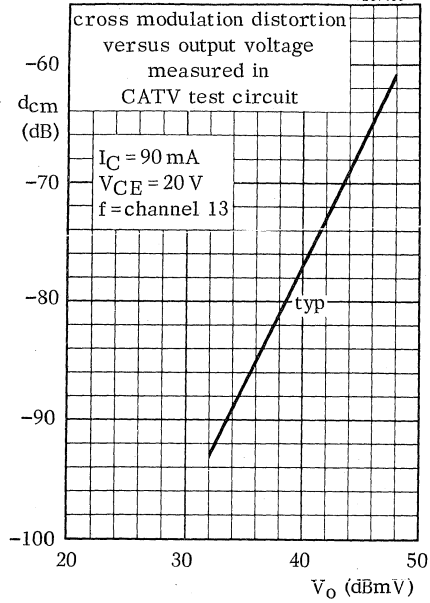

7267485

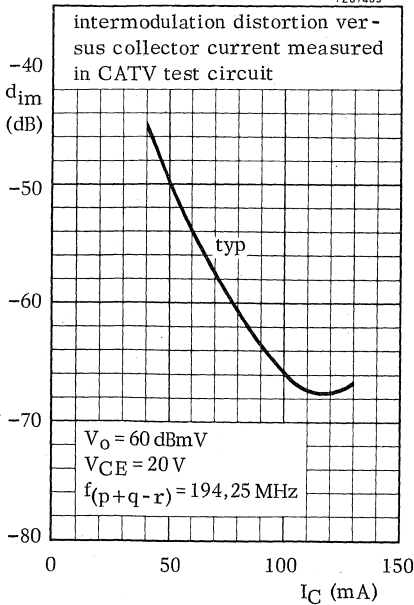

7267488

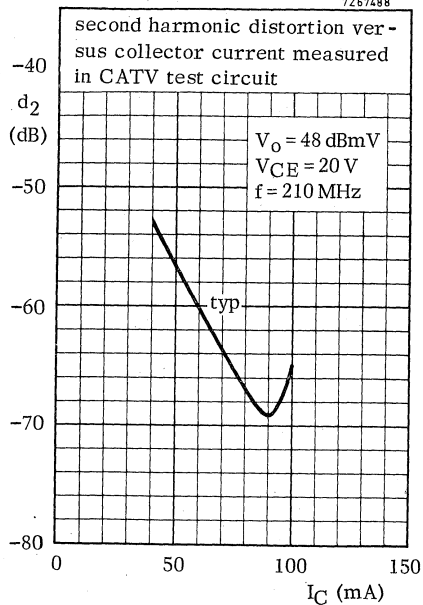

SILICON PLANAR EPITAXIAL TRANSISTORS

P-N-P transistors in a TO-39 metal envelope with the collector connected to the case. These transistors are intended for general industrial applications.

| | | QUICK REFERENCE DATA | | | | | |
|---|--------------|----------------------|-----------|-----------|-----------|------------------|-----|
| | | BFS 92 | BFS 93 | BFS 94 | BFS 95 | | |
| Collector-base voltage (open emitter) | $-V_{CBO}$ | max. 100 | 100 | 80 | 40 | V | |
| Collector-emitter voltage (open base) | $-V_{CEO}$ | max. 60 | 60 | 40 | 35 | V | |
| Collector current (d. c.) | $-I_C$ | max. 1,0 | 1,0 | 1,0 | 1,0 | A | |
| Total power dissipation up to $T_{mb} = 50\text{ }^\circ\text{C}$ | P_{tot} | max. 5 | 5 | 5 | 5 | W | |
| Junction temperature | T_j | max. 200 | 200 | 200 | 200 | $^\circ\text{C}$ | |
| Collector-emitter saturation voltage $-I_C = 500\text{ mA}; -I_B = 50\text{ mA}$ | $-V_{CEsat}$ | < | 1,0 | 1,0 | 0,7 | 0,7 | V |
| D. C. current gain $-I_C = 150\text{ mA}; -V_{CE} = 10\text{ V}$ | h_{FE} | > | 30 | 70 | 40 | 70 | |
| Transition frequency at $f = 35\text{ MHz}$ $-I_C = 50\text{ mA}; -V_{CE} = 10\text{ V}$ | f_T | typ. | 70 | 70 | 70 | 70 | MHz |

MECHANICAL DATA

Dimensions in mm

TO-39
Collector connected
to case

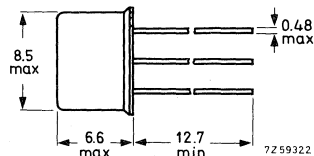
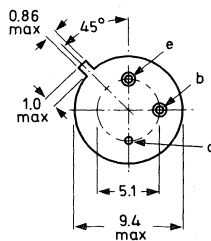

max. lead diameter is guaranteed only for 12,7 mm.

Accessories supplied on request: 56218; 56245.

RATINGS Limiting values in accordance with the Absolute Maximum System (IEC 134)

Voltages

| | | | BFS | BFS | BFS | BFS |
|---------------------------------------|------------|------|-----|-----|-----|------|
| | | | 92 | 93 | 94 | 95 |
| Collector-base voltage (open emitter) | $-V_{CBO}$ | max. | 100 | 100 | 80 | 40 V |
| Collector-emitter voltage (open base) | $-V_{CEO}$ | max. | 60 | 60 | 40 | 35 V |
| Emitter-base voltage (open collector) | $-V_{EBO}$ | max. | 6 | 6 | 6 | 6 V |

Currents

| | | | |
|-----------------------------------|-----------|------|--------|
| Collector current (d. c.) | $-I_C$ | max. | 1.0 A |
| Collector current (peak value) | $-I_{CM}$ | max. | 1.0 A |
| Emitter current (d. c.) | I_E | max. | 1.0 A |
| Emitter current (peak value) | I_{EM} | max. | 1.0 A |
| Reverse base current (peak value) | $+I_{BM}$ | max. | 100 mA |

Power dissipation

Total power dissipation up to $T_{mb} = 50\text{ }^\circ\text{C}$

See page 6

| | | |
|-----------|------|-----|
| P_{tot} | max. | 5 W |
|-----------|------|-----|

Temperatures

| | | |
|----------------------|-----------|------------------------------|
| Storage temperature | T_{stg} | -65 to +200 $^\circ\text{C}$ |
| Junction temperature | T_j | max. 200 $^\circ\text{C}$ |

THERMAL RESISTANCE

| | | | |
|--------------------------------------|----------------|---|------------------------|
| From junction to ambient in free air | $R_{th\ j-a}$ | = | 220 $^\circ\text{C/W}$ |
| From junction to case | $R_{th\ j-c}$ | = | 35 $^\circ\text{C/W}$ |
| From junction to mounting base | $R_{th\ j-mb}$ | = | 30 $^\circ\text{C/W}$ |

CHARACTERISTICS

$T_j = 25\text{ }^\circ\text{C}$ unless otherwise specified

Collector cut-off current

$I_E = 0; -V_{CB} = 80\text{ V}; T_j = 25\text{ }^\circ\text{C}$
 $T_j = 100\text{ }^\circ\text{C}$

BFS92; BFS93 $-I_{CBO} < 50\text{ nA}$
 $-I_{CBO} < 2.5\text{ }\mu\text{A}$

$I_E = 0; -V_{CB} = 60\text{ V}; T_j = 25\text{ }^\circ\text{C}$
 $T_j = 100\text{ }^\circ\text{C}$

BFS94 $-I_{CBO} < 50\text{ nA}$
 $-I_{CBO} < 2.5\text{ }\mu\text{A}$

$I_E = 0; -V_{CB} = 30\text{ V}; T_j = 25\text{ }^\circ\text{C}$
 $T_j = 100\text{ }^\circ\text{C}$

BFS95 $-I_{CBO} < 50\text{ nA}$
 $-I_{CBO} < 2.5\text{ }\mu\text{A}$

Emitter cut-off current

$I_C = 0; -V_{EB} = 5\text{ V}; T_j = 25\text{ }^\circ\text{C}$
 $T_j = 100\text{ }^\circ\text{C}$

$-I_{EBO} < 50\text{ nA}$
 $-I_{EBO} < 2.5\text{ }\mu\text{A}$

Saturation voltages

$-I_C = 10\text{ mA}; -I_B = 1\text{ mA}$

| | BFS92 | BFS93 | BFS94 | BFS95 |
|--------------|----------|--------|--------|-----------------|
| $-V_{CEsat}$ | < 0.15 | 0.15 | 0.10 | 0.10 V |
| $-V_{BEsat}$ | < 1.2 | 1.2 | 1.2 | 1.2 V |
| $-V_{CEsat}$ | < 0.35 | 0.35 | 0.20 | 0.20 V |
| $-V_{BEsat}$ | < 1.3 | 1.3 | 1.3 | 1.3 V |
| $-V_{CEsat}$ | < 1.00 | 1.00 | 0.70 | 0.70 V |
| $-V_{BEsat}$ | < 1.5 | 1.5 | 1.5 | 1.5 V |
| $-V_{CEsat}$ | < 2.00 | 1.60 | 1.00 | 1.00 V |
| $-V_{BEsat}$ | < 2.0 | 2.0 | 2.0 | 2.0 V |

$-I_C = 150\text{ mA}; -I_B = 15\text{ mA}$

$-I_C = 500\text{ mA}; -I_B = 50\text{ mA}$

$-I_C = 1\text{ A}; -I_B = 100\text{ mA}$

D.C. current gain

$-I_C = 10\text{ mA}; -V_{CE} = 10\text{ V}$

$h_{FE} > 20$ 50 30 50

$-I_C = 150\text{ mA}; -V_{CE} = 10\text{ V}$

$h_{FE} > 30$ 70 40 70

$-I_C = 500\text{ mA}; -V_{CE} = 10\text{ V}$

$h_{FE} > 20$ 30 25 30

$-I_C = 1\text{ A}; -V_{CE} = 10\text{ V}$

$h_{FE} > 15$ 15 15 15

Collector capacitance at $f = 1\text{ MHz}$

$I_E = I_e = 0; -V_{CB} = 10\text{ V}$

$C_C < 20\text{ pF}$

Transition frequency at $f = 35\text{ MHz}$

$-I_C = 50\text{ mA}; -V_{CE} = 10\text{ V}$

$f_T > 40\text{ MHz}$
 typ. 70 MHz

CHARACTERISTICS (continued)

h parameters at f = 1 kHz

$-I_C = 10 \text{ mA}; -V_{CE} = 5 \text{ V}$

| | | | | |
|--------------------------------|----------|------|-----|------------------|
| Input impedance | h_{ie} | typ. | 300 | Ω |
| Reverse voltage transfer ratio | h_{re} | typ. | 70 | 10^{-6} |
| Small signal current gain | h_{fe} | typ. | 100 | |
| Output admittance | h_{oe} | typ. | 60 | $\mu\Omega^{-1}$ |

$-I_C = 1 \text{ mA}; -V_{CE} = 5 \text{ V}$

| | | | | |
|---------------------------|----------|------|----|--|
| Small signal current gain | h_{fe} | typ. | 90 | |
|---------------------------|----------|------|----|--|

Switching times (see also page 5)

Turn on time

$-I_C = 150 \text{ mA}; -I_B = +I_{BM} = 15 \text{ mA}$

| | | | | |
|------------|-------|------|----|----|
| delay time | t_d | typ. | 20 | ns |
| rise time | t_r | typ. | 35 | ns |

Turn off time

$-I_C = 150 \text{ mA}; -I_B = +I_{BM} = 15 \text{ mA}$

| | | | | |
|--------------|-------|------|-----|----|
| storage time | t_s | typ. | 500 | ns |
| fall time | t_f | typ. | 65 | ns |

MEASUREMENT OF SWITCHING TIMES

Fig. 1: Circuit diagram

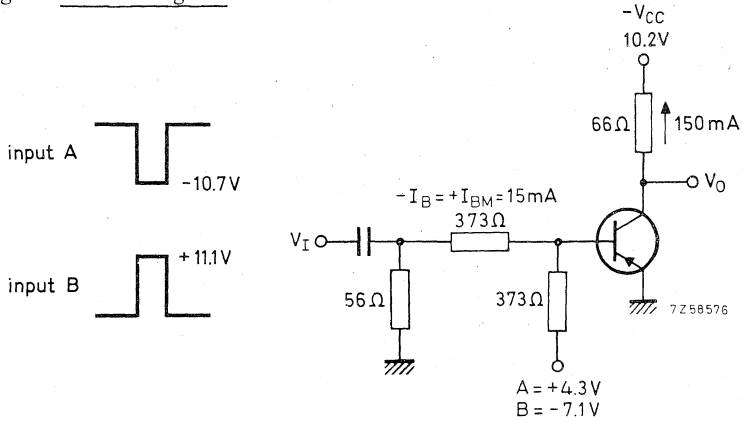
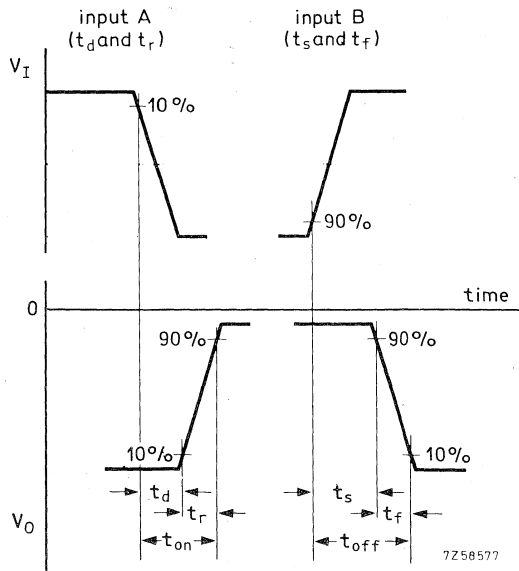
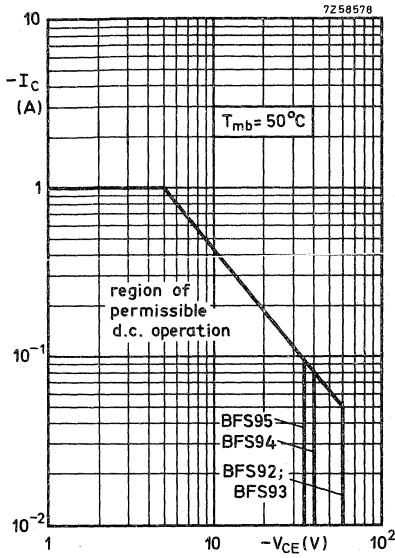

Fig. 2: Waveforms



Equipment: Pulse generator (rise time = 1 ns)
Double beam or dual trace oscilloscope (rise time < 5 ns)



Safe Operating Area
with the transistor forward biased

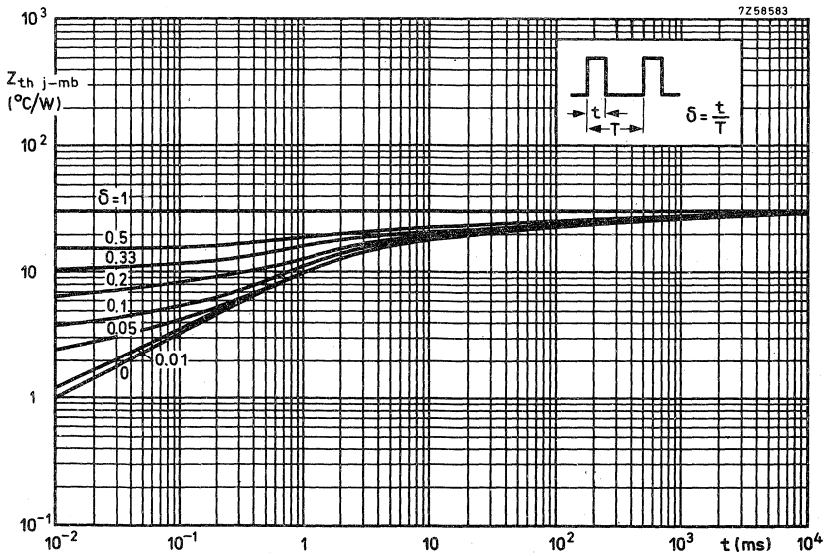

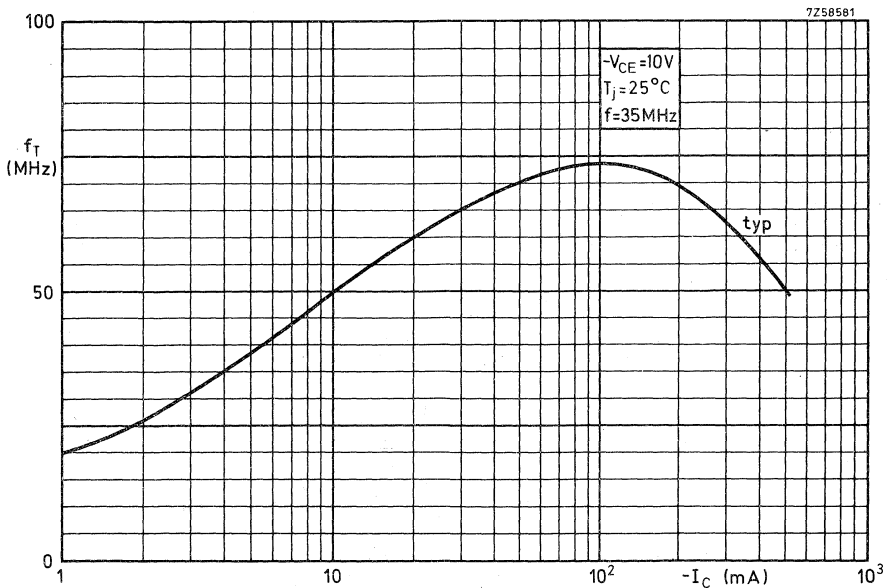
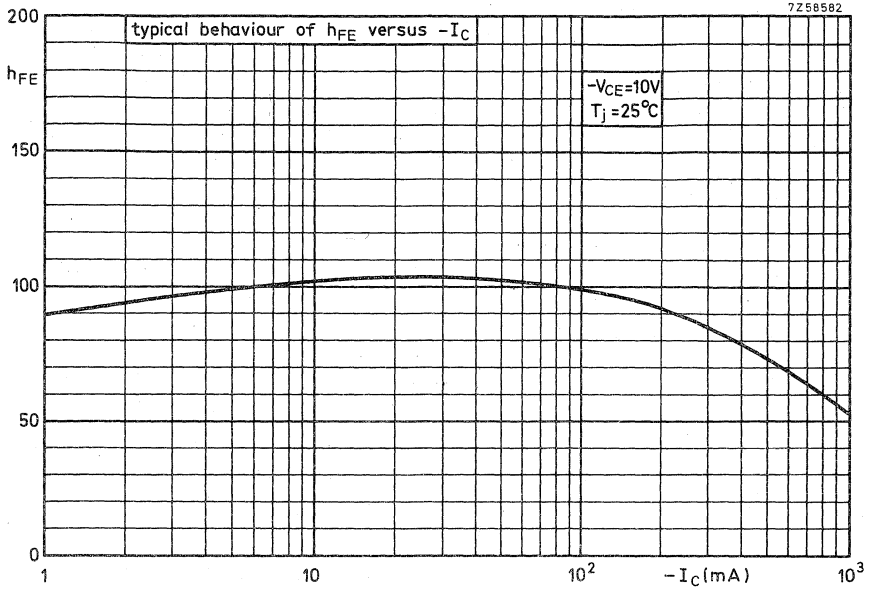

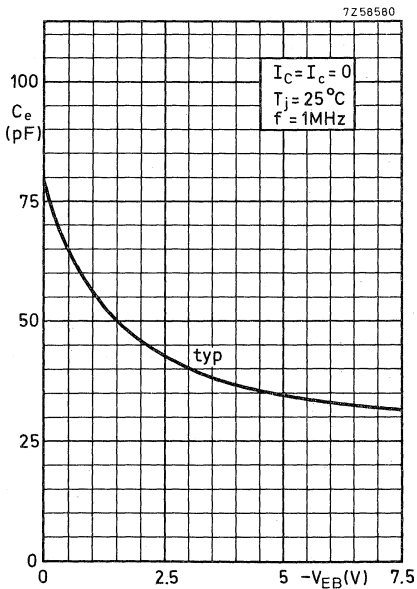
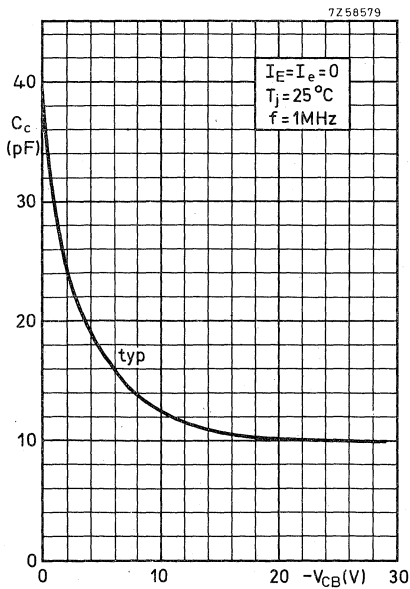
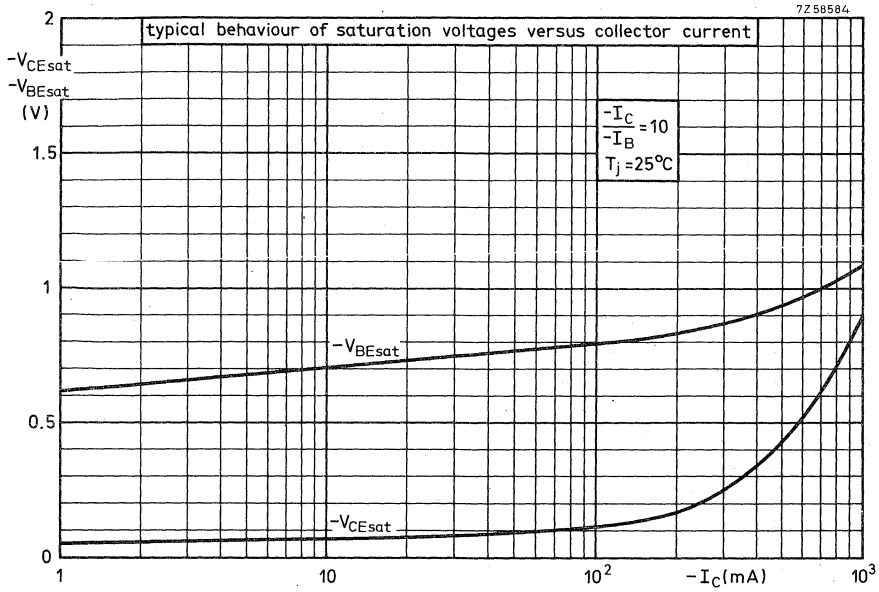

SILICON PLANAR EPITAXIAL TRANSISTOR

N-P-N transistor in a subminiature plastic transfer-moulded T-package.

It is primarily intended for use in u. h. f. low power amplifiers such as in pocket phones, paging systems, etc.

The transistor features low current consumption (100 μ A - 1 mA); thanks to its high transition frequency, it also has excellent wideband properties and low noise up to high frequencies.

QUICK REFERENCE DATA

| | | | | |
|--|-----------|------|-----|-----|
| Collector-base voltage (open emitter) | V_{CBO} | max. | 8 | V |
| Collector-emitter voltage (open base) | V_{CEO} | max. | 5 | V |
| Collector current (d. c.) | I_C | max. | 2,5 | mA |
| Total power dissipation up to $T_{amb} = 135$ °C | P_{tot} | max. | 30 | mW |
| Junction temperature | T_j | max. | 150 | °C |
| Transition frequency at $f = 500$ MHz $I_C = 1$ mA; $V_{CE} = 1$ V | f_T | typ. | 2,3 | GHz |
| Feedback capacitance at $f = 1$ MHz $I_C = 1$ mA; $V_{CE} = 1$ V; $T_{amb} = 25$ °C | C_{re} | < | 0,4 | pF |
| Noise figure at optimum source impedance $I_C = 1$ mA; $V_{CE} = 1$ V; $f = 500$ MHz; $T_{amb} = 25$ °C | F | typ. | 3,8 | dB |
| Max. unilateral power gain (see page 3) $I_C = 1$ mA; $V_{CE} = 1$ V; $f = 500$ MHz; $T_{amb} = 25$ °C | G_{UM} | typ. | 17 | dB |

MECHANICAL DATA

Dimensions in mm

SOT-37

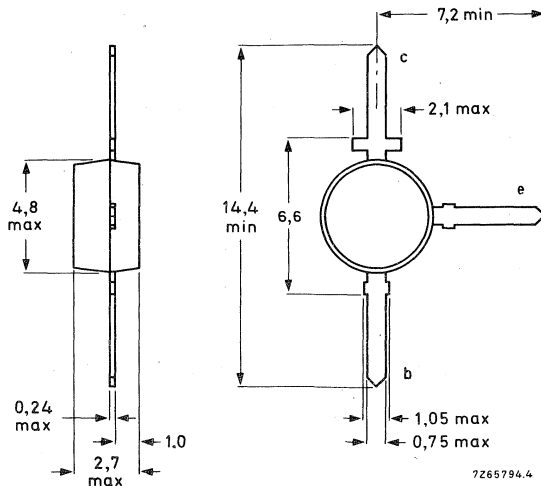

RATINGS Limiting values in accordance with the Absolute Maximum System (IEC134)

Voltages

| | | | | |
|---------------------------------------|-----------|------|---|---|
| Collector-base voltage (open emitter) | V_{CBO} | max. | 8 | V |
| Collector-emitter voltage (open base) | V_{CEO} | max. | 5 | V |
| Emitter-base voltage (open collector) | V_{EBO} | max. | 2 | V |

Current

| | | | | |
|---|----------|------|-----|----|
| Collector current (d. c.) | I_C | max. | 2,5 | mA |
| Collector current (peak value; $f > 1$ MHz) | I_{CM} | max. | 5,0 | mA |

Power dissipation

| | | | | |
|--|-----------|------|----|----|
| Total power dissipation up to $T_{amb} = 135$ °C | P_{tot} | max. | 30 | mW |
|--|-----------|------|----|----|

Temperatures

| | | | |
|----------------------|-----------|-------------|----|
| Storage temperature | T_{stg} | -65 to +150 | °C |
| Junction temperature | T_j | max. 150 | °C |

THERMAL RESISTANCE

From junction to ambient in free air

mounted on a glass-fibre print *)
of 40 mm x 25 mm x 1 mm

$$R_{th\ j-a} = 0,5 \text{ °C/mW}$$

*) Requirements for glass-fibre print

(dimensions in mm)

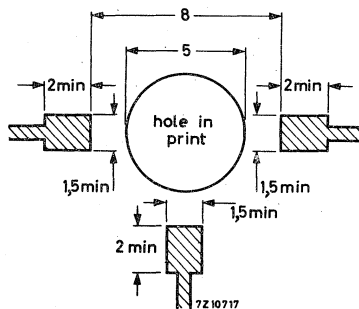

CHARACTERISTICS

$T_j = 25\text{ }^\circ\text{C}$ unless otherwise specified

Collector cut-off current

$I_E = 0; V_{CB} = 5\text{ V}$ $I_{CBO} < 50\text{ nA}$

D. C. current gain 1)

$I_C = 10\text{ }\mu\text{A}; V_{CE} = 1\text{ V}$ $h_{FE} > 20$
typ. 30

$I_C = 1\text{ mA}; V_{CE} = 1\text{ V}$ $h_{FE} > 20$
typ. 40

Saturation voltages

$I_C = 10\text{ }\mu\text{A}; I_B = 1\text{ mA}$ $V_{CEsat} < 100\text{ mV}$
 $V_{BEsat} < 700\text{ mV}$

$I_C = 1\text{ mA}; I_B = 0,1\text{ mA}$ $V_{CEsat} < 125\text{ mV}$
 $V_{BEsat} < 850\text{ mV}$

Transition frequency at $f = 500\text{ MHz}$ 1)

$I_C = 1\text{ mA}; V_{CE} = 1\text{ V}$ $f_T > 1,2\text{ GHz}$
typ. 2,3 GHz

Collector capacitance at $f = 1\text{ MHz}$

$I_E = I_c = 0; V_{CB} = 0,5\text{ V}$ $C_c < 0,55\text{ pF}$

Emitter capacitance at $f = 1\text{ MHz}$

$I_C = I_c = 0; V_{EB} = 0$ $C_e < 0,45\text{ pF}$

Feedback capacitance at $f = 1\text{ MHz}$

$I_C = 1\text{ mA}; V_{CE} = 1\text{ V}; T_{amb} = 25\text{ }^\circ\text{C}$ $C_{re} < 0,4\text{ pF}$

Noise figure at optimum source impedance

$I_C = 0,1\text{ mA}; V_{CE} = 1\text{ V}; f = 500\text{ MHz}; T_{amb} = 25\text{ }^\circ\text{C}$ F typ. 5,5 dB

$I_C = 1\text{ mA}; V_{CE} = 1\text{ V}; f = 500\text{ MHz}; T_{amb} = 25\text{ }^\circ\text{C}$ F typ. 3,8 dB

Max. unilateral power gain (s_{re} assumed to be zero)

$$G_{UM} \text{ (in dB)} = 10 \log \frac{|s_{fe}|^2}{(1 - |s_{ie}|^2)(1 - |s_{oe}|^2)}$$

$I_C = 1\text{ mA}; V_{CE} = 1\text{ V}; f = 200\text{ MHz}; T_{amb} = 25\text{ }^\circ\text{C}$ G_{UM} typ. 24 dB

$I_C = 1\text{ mA}; V_{CE} = 1\text{ V}; f = 500\text{ MHz}; T_{amb} = 25\text{ }^\circ\text{C}$ G_{UM} typ. 17 dB

$I_C = 1\text{ mA}; V_{CE} = 1\text{ V}; f = 800\text{ MHz}; T_{amb} = 25\text{ }^\circ\text{C}$ G_{UM} typ. 11 dB

1) Measured under pulse conditions.

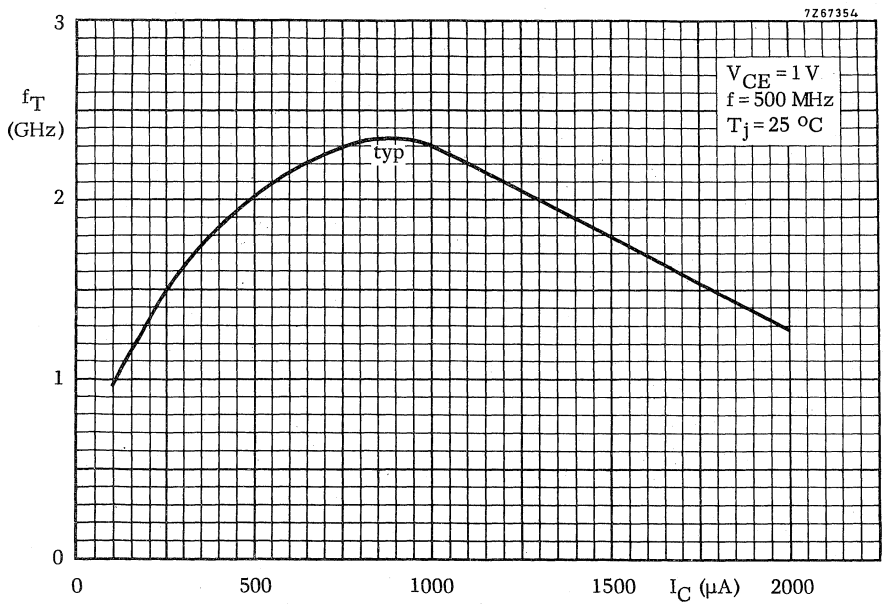
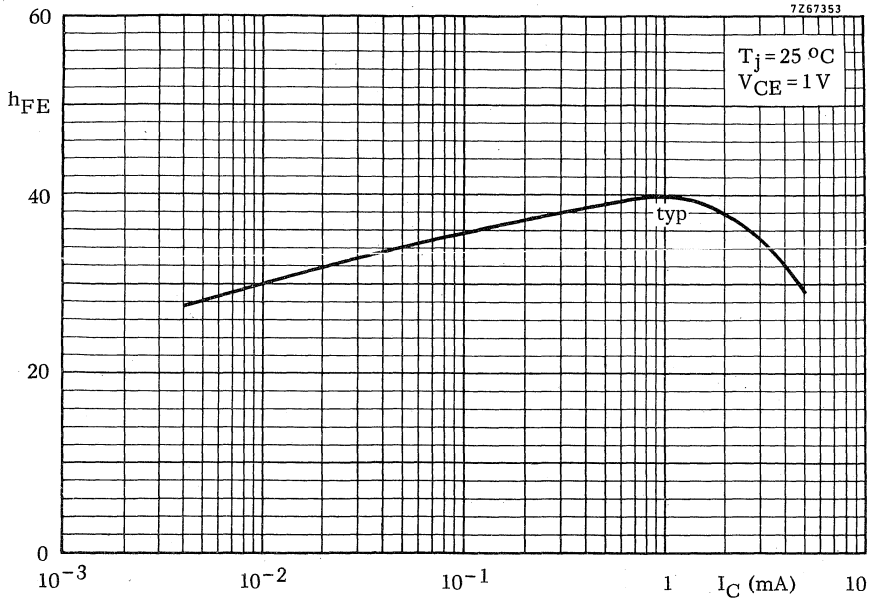

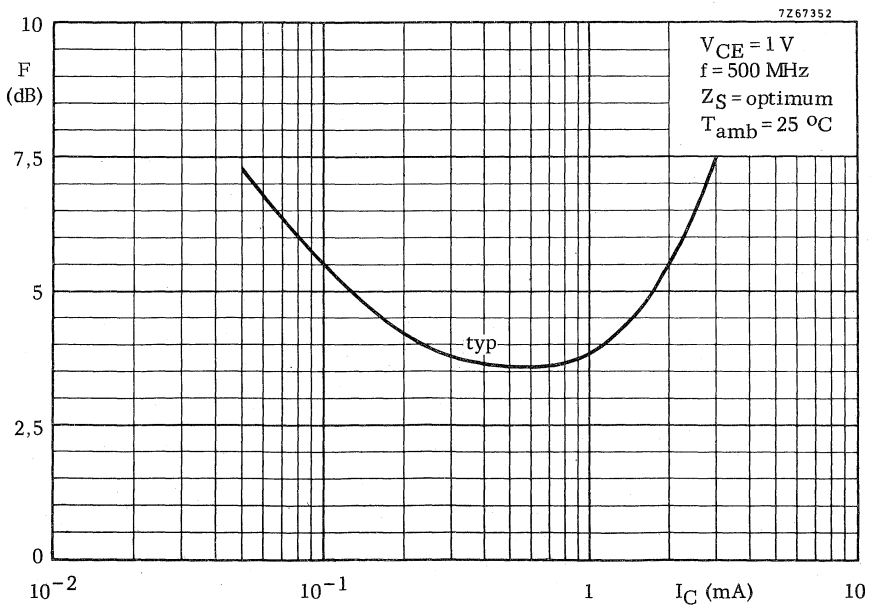
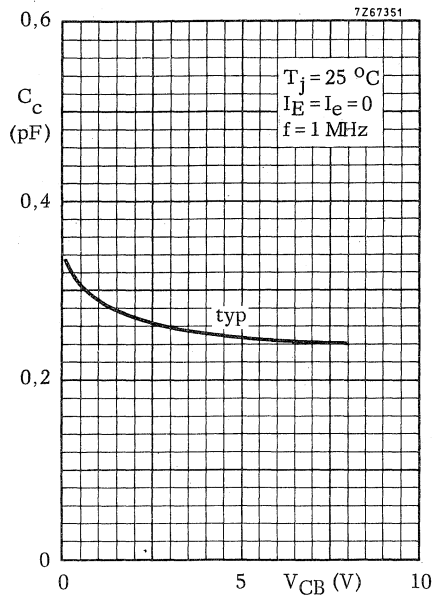

$V_{CE} = 1\text{ V}$
 $I_C = 1\text{ mA}$
 $T_{amb} = 25\text{ }^\circ\text{C}$

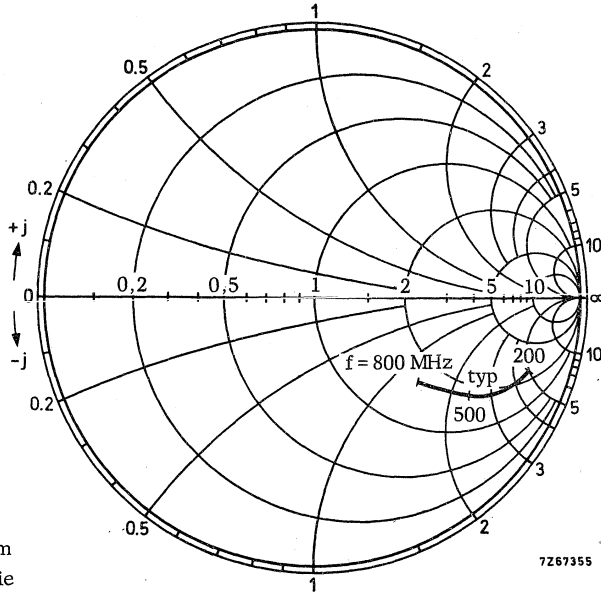

$V_{CE} = 1\text{ V}$
 $I_C = 1\text{ mA}$
 $T_{amb} = 25\text{ }^\circ\text{C}$

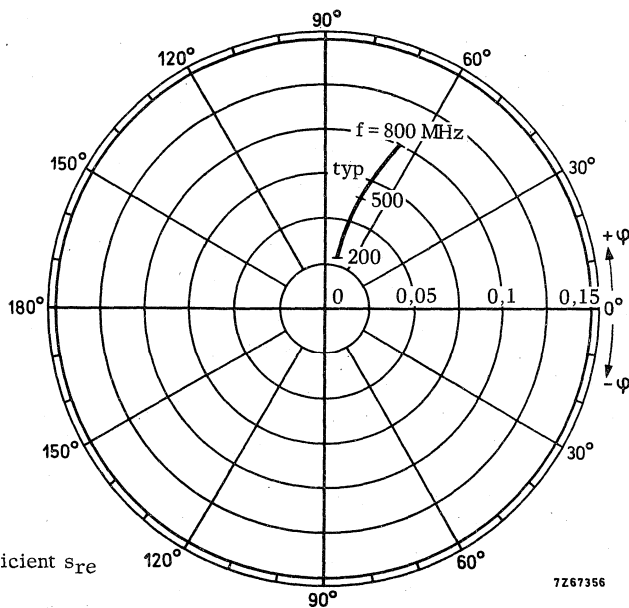

$V_{CE} = 1\text{ V}$
 $I_C = 1\text{ mA}$
 $T_{amb} = 25\text{ }^\circ\text{C}$

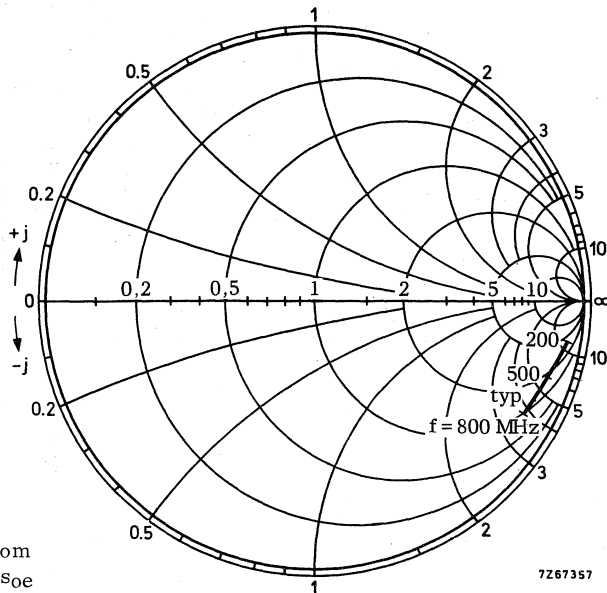

Output impedance derived from output reflection coefficient s_{oe} coordinates in ohm x 50

$V_{CE} = 1\text{ V}$
 $I_C = 1\text{ mA}$
 $T_{amb} = 25\text{ }^\circ\text{C}$

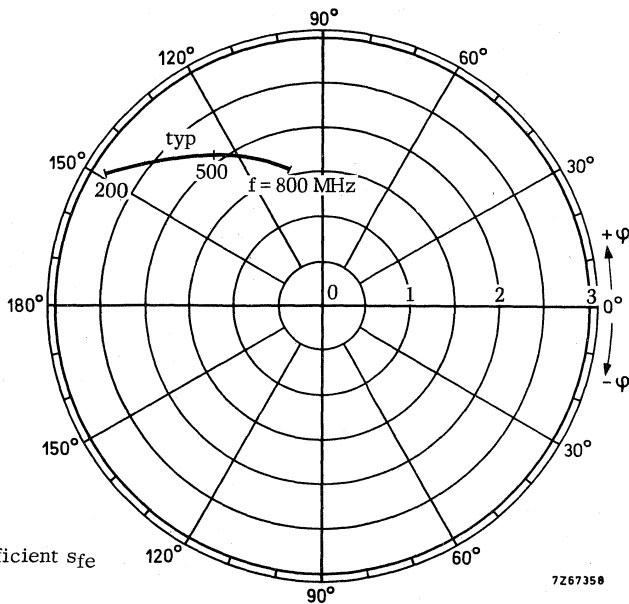

Forward transmission coefficient s_{fe}

SILICON PLANAR EPITAXIAL TRANSISTOR

N-P-N multi-emitter transistor in a TO-39 metal envelope, with the collector connected to the case. The transistor has extreme good intermodulation properties and a high power gain. It is a ruggedized version of the BFW16, which it succeeds. It is primarily intended for:

- Final and driver stages of channel- and band aerial amplifiers with high output power for band I, II, III and IV/V (40-860 MHz).
- Final stage of the wide band vertical amplifier in high speed oscilloscopes.

QUICK REFERENCE DATA

| | | | |
|---|------------|---------------|-------------|
| Collector-base voltage (open emitter; peak value) | V_{CBOM} | max. | 40 V |
| Collector-emitter voltage (open base) | V_{CEO} | max. | 25 V |
| Collector current (peak value; $f > 1$ MHz) | I_{CM} | max. | 300 mA |
| Total power dissipation up to $T_{mb} = 125$ °C | P_{tot} | max. | 1.5 W |
| Junction temperature | T_j | max. | 200 °C |
| Feedback capacitance at $f = 1$ MHz $I_C = 10$ mA; $V_{CE} = 15$ V | C_{re} | typ. | 1.7 pF |
| Transition frequency $I_C = 150$ mA; $V_{CE} = 15$ V; $f = 500$ MHz | f_T | typ. | 1.2 GHz |
| Power gain (not neutralized) $I_C = 70$ mA; $V_{CE} = 18$ V | G_p | $f = 200$ MHz | 800 MHz |
| | | typ. | 16 6.5 dB |
| Output power $d_{im} = -30$ dB; V.S.W.R. at output < 2 $I_C = 70$ mA; $V_{CE} = 18$ V | P_o | typ. | 150 90 mW |

MECHANICAL DATA

Dimensions in mm

Collector connected to case

TO-39

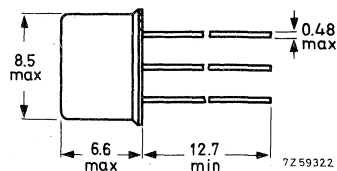
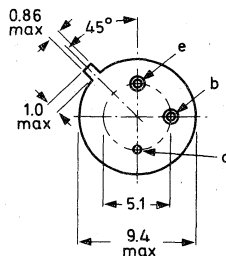

Accessories available: 56218; 56245.

RATINGS Limiting values in accordance with the Absolute Maximum System (IEC 134)Voltages

| | | | |
|--|------------|------|---------|
| Collector-base voltage (open emitter; peak value) | V_{CBOM} | max. | 40 V |
| Collector-emitter voltage ($R_{BE} \leq 50 \Omega$) peak value | V_{CERM} | max. | 40 V 1) |
| Collector-emitter voltage (open base) | V_{CEO} | max. | 25 V 1) |
| Emitter-base voltage (open collector) | V_{EBO} | max. | 2 V |

Currents

| | | | |
|---|----------|------|--------|
| Collector current (d.c.) | I_C | max. | 150 mA |
| Collector current (peak value; $f > 1$ MHz) | I_{CM} | max. | 300 mA |

Power dissipation

| | | | |
|---|-----------|------|-------|
| Total power dissipation up to $T_{mb} = 125 \text{ }^\circ\text{C}$ | P_{tot} | max. | 1.5 W |
|---|-----------|------|-------|

Temperatures

| | | | |
|----------------------|-----------|-------------|----------------------|
| Storage temperature | T_{stg} | -65 to +200 | $^\circ\text{C}$ |
| Junction temperature | T_j | max. | 200 $^\circ\text{C}$ |

THERMAL RESISTANCE

| | | | |
|--|---------------|---|------------------------|
| From junction to ambient in free air | $R_{th j-a}$ | = | 250 $^\circ\text{C/W}$ |
| From junction to mounting base | $R_{th j-mb}$ | = | 50 $^\circ\text{C/W}$ |
| From mounting base to heatsink mounted with top clamping washer of 56218 and a boron nitride washer for electrical insulation | $R_{th mb-h}$ | = | 1.2 $^\circ\text{C/W}$ |

1) $I_C = 10 \text{ mA}$.

CHARACTERISTICS

$T_j = 25\text{ }^\circ\text{C}$ unless otherwise specified

Collector cut-off current

$I_E = 0; V_{CB} = 20\text{ V}; T_j = 150\text{ }^\circ\text{C}$ $I_{CBO} < 20\text{ }\mu\text{A}$

Knee voltage

$I_C = 100\text{ mA}; I_B = \text{value for which}$
 $I_C = 110\text{ mA at } V_{CE} = 1\text{ V}$ $V_{CEK} < 0.75\text{ V}$

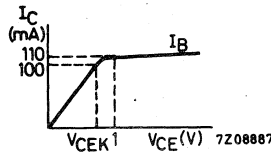

D.C. current gain

$I_C = 50\text{ mA}; V_{CE} = 5\text{ V}$ $h_{FE} > 25$

$I_C = 150\text{ mA}; V_{CE} = 5\text{ V}$ $h_{FE} > 25$

Transition frequency

$I_C = 150\text{ mA}; V_{CE} = 15\text{ V}; f = 500\text{ MHz}$ $f_T \text{ typ. } 1.2\text{ GHz}$

Collector capacitance at $f = 1\text{ MHz}$

$I_E = I_e = 0; V_{CB} = 15\text{ V}$ $C_c < 4\text{ pF}$

Feedback capacitance at $f = 1\text{ MHz}$

$I_C = 10\text{ mA}; V_{CE} = 15\text{ V}; T_{amb} = 25\text{ }^\circ\text{C}$ $C_{re} \text{ typ. } 1.7\text{ pF}$

Noise figure at $f = 200\text{ MHz}$

$I_C = 30\text{ mA}; V_{CE} = 15\text{ V}; R_S = 75\text{ }\Omega; T_{amb} = 25\text{ }^\circ\text{C}$ $F < 6\text{ dB}$

Power gain (not neutralized)

$I_C = 70\text{ mA}; V_{CE} = 18\text{ V}; T_{amb} = 25\text{ }^\circ\text{C}$

| | | |
|------------------------|--|------------------|
| $f = 200$ | | 800 MHz |
| $G_p \text{ typ. } 16$ | | 6.5 dB |

CHARACTERISTICS (continued)

Intermodulation characteristics

1. Output power at $f = 200 \text{ MHz}$; $T_{\text{amb}} = 25 \text{ }^\circ\text{C}$

$I_C = 70 \text{ mA}$; $V_{CE} = 18 \text{ V}$; V.S.W.R. at output < 2

$f_p = 202 \text{ MHz}$; $f_q = 205 \text{ MHz}$; $d_{\text{im}} = -30 \text{ dB}$

measured at $f(2q-p) = 208 \text{ MHz}$ (Channel 9)

$P_o > 130 \text{ mW}$
typ. 150 mW

Test circuit:

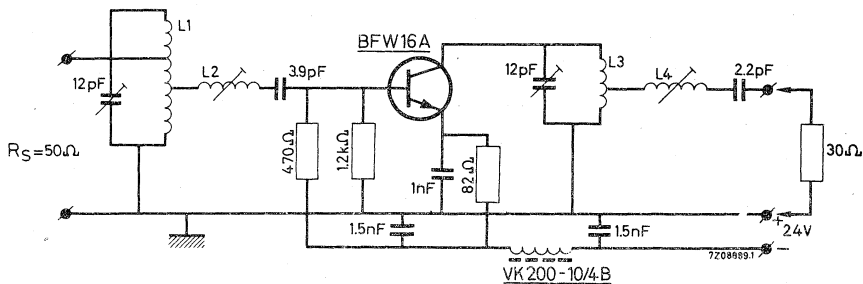

Coil data:

L1 = 3 turns silver plated Cu wire (1.4 mm); winding pitch 2.7 mm;
int. diam. 8 mm; taps at 0.5 turn and 1.5 turns from earth.

L2 = 5.5 turns silver plated Cu wire (1.4 mm); winding pitch 2.2 mm;
int. diam. 8 mm.

L3 = 3 turns silver plated Cu wire (1.4 mm); winding pitch 3.3 mm;
int. diam. 8 mm.

L4 = 5.5 turns silver plated Cu wire (1.4 mm); winding pitch 2.2 mm;
int. diam. 11 mm.

CHARACTERISTICS (continued)

Basis of adjustment

The intermodulation at an intermodulation distortion of -30 dB is caused by h.f. output current - voltage clipping.

The maximum undistorted output power is realised, if

- a. Current and voltage clipping take place concurrently.
This occurs if

$$R_L = \frac{V_{CE} - V_{CEK}}{I_C},$$

in which V_{CEK} is the high frequency knee voltage.

- b. The h.f. collector current is as small as possible.

This is so if $-C_L = +C_{Oe}$,

in which C_{Oe} is the output capacitance of the transistor at short circuited input.

For maximum output power at an intermodulation distortion of -30 dB, the (experimentally found) values of R_L and C_L are:

$$R_L = 220 \Omega; C_L = -5.6 \text{ pF.}$$

C_{Oe} is found by 4 pF of the transistor and 1.6 pF by the mounting system concerning of a borium nitride washer between the envelope of the transistor and the chassis. See also page 10, note 1.

Adjustment procedure

1. Remove the transistor and connect a dummy consisting of a 220- Ω resistor in parallel with a 5.6 pF capacitor between the collector and emitter connections of the output circuit.
2. Tune and match the output circuit for zero reflection at 205 MHz (V.S.W.R. = 1). After this adjustment, no further change may be made in the output circuit.
3. Replace the dummy by the transistor. Tune and match the input circuit for maximum power gain and good band pass curve.
The V.S.W.R. of the output will then, in most cases, be ≤ 2 over the whole channel.
Corrections can be made by tuning L2; this will not disturb the band pass curve.

CHARACTERISTICS (continued)

Intermodulation characteristics

2. Output power at $f = 800 \text{ MHz}$; $T_{\text{amb}} = 25 \text{ }^\circ\text{C}$
 $I_C = 70 \text{ mA}$; $V_{CE} = 18 \text{ V}$; V.S.W.R. at output < 2
 $f_p = 798 \text{ MHz}$; $f_q = 802 \text{ MHz}$; $d_{\text{im}} = -30 \text{ dB}$
 measured at $f(2q-p) = 806 \text{ MHz}$ (Channel 62)

$$P_o > 70 \text{ mW}$$

$$\text{typ. } 90 \text{ mW}$$

Test circuit:

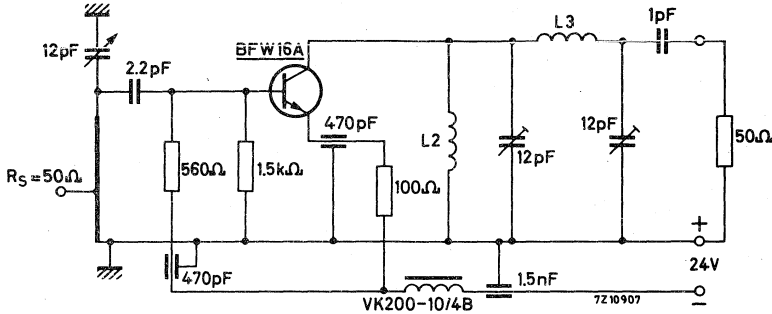

Coil data:

- L1 = 25 mm x 7 mm x 0.85 mm silver plated Cu strip
 Tap of the input at 5 mm from earth.
 L2 = 13 turns enamelled Cu wire (0.6 mm); int. diam. 8 mm
 L3 = 1.5 turns Cu wire (1.3 mm); int. diam. 8 mm

Basis of adjustment

At 800 MHz no dummy can be used to adjust for optimum collector load because at these frequencies the impedance transformations of a dummy are too high. A small signal at the mid-channel frequency of 802 MHz is fed to the input and increased until clipping occurs; that is, until the output power no longer increases linearly with the input signal. This clipping can be eliminated by tuning the output circuit, thereby making the output power equal to

$$P_o = \frac{I_C(V_{CE} - V_{CEK})}{2} = 480 \text{ mW.}$$

The output circuit is adjusted for minimum intermodulation if the input signal is as small as possible at $P_o = 480 \text{ mW}$.

With this adjusting method care must be taken, that the transistor is not destructed by second breakdown (the voltage swing may not exceed the rated V_{CER} value). Therefore as soon as clipping occurs, the increase of the input signal should be stopped until the clipping has been eliminated. After this adjustment has been made no further change may be made in the output circuit.

Adjust the input circuit for maximum power gain and good band pass curve. The V.S.W.R. of the output is then ≤ 2 over the whole channel.

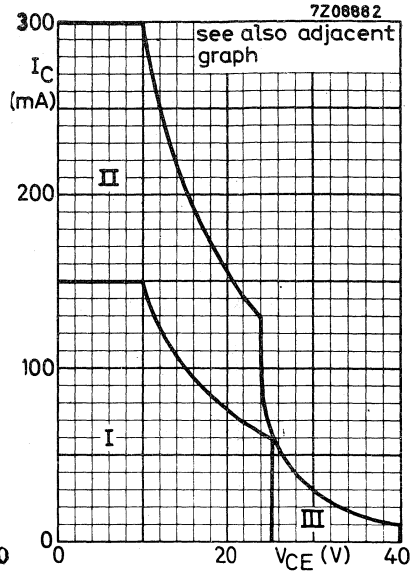
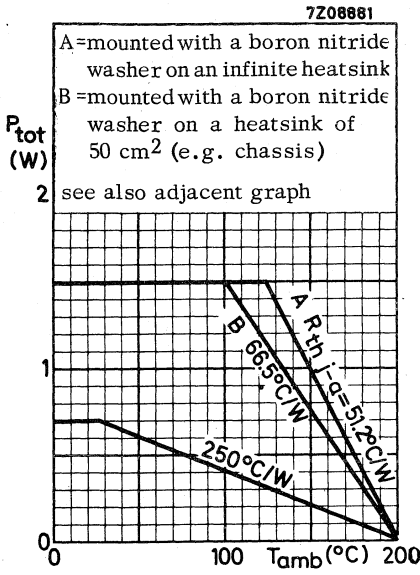

- I = Region of permissible operation under all base-emitter conditions and at all frequencies, including d.c.
- II = Additional region of operation at $f \geq 1$ MHz.
- III = Operating under pulsed conditions is allowed, provided the transistor is cut-off with $R_{BE} \leq 50 \Omega$ and $f \geq 1$ MHz.

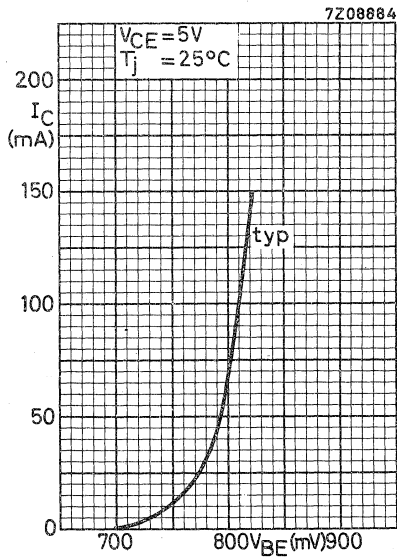
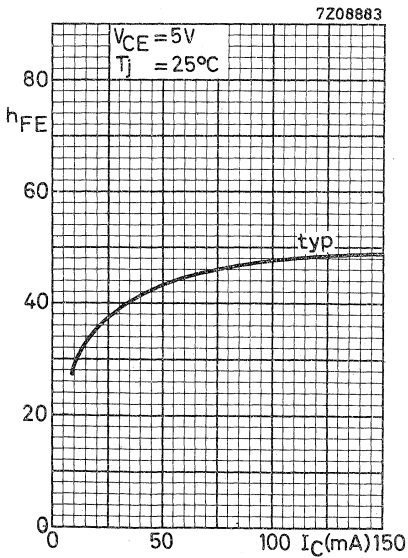
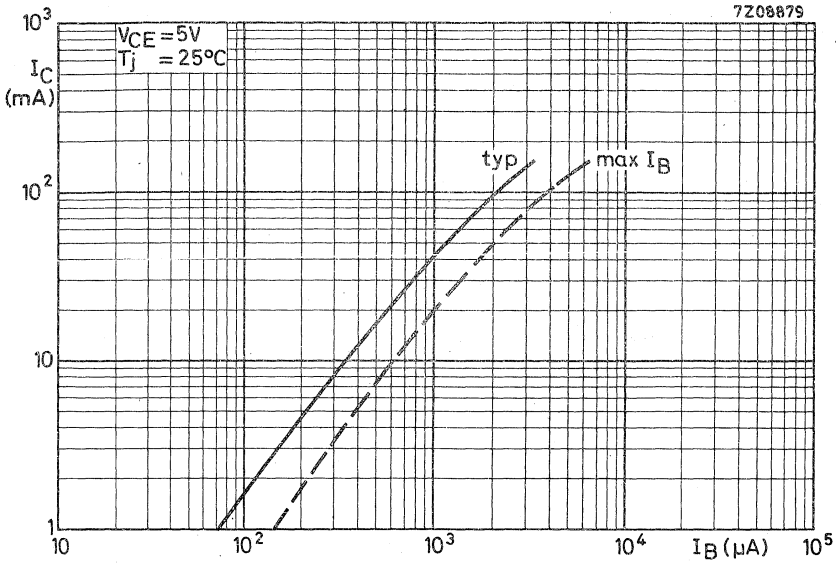

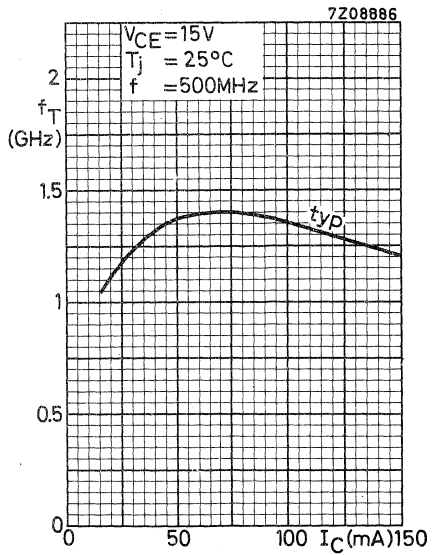
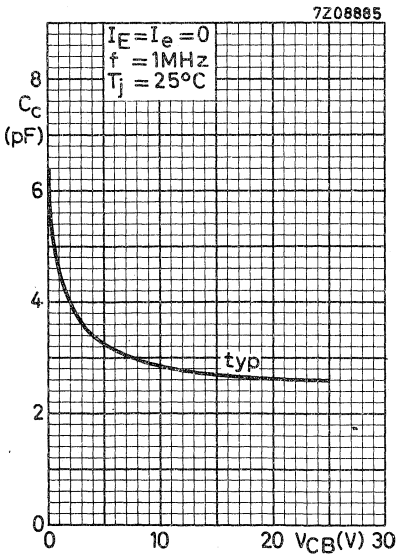
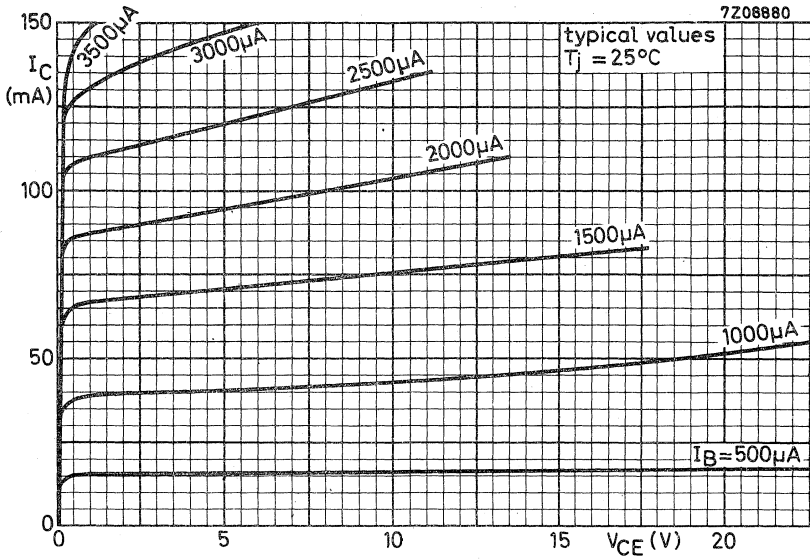

APPLICATION INFORMATION

Performance of channel- and band amplifiers ¹⁾

| Frequency range | channel 4 61-68 | channel 9 202-209 | channel 55 742-750 | band I 47-68 | band II 87.5-108 | band III 174-230 | MHz |
|--|-----------------------|-------------------------|--------------------------|--------------------|------------------------|------------------------|----------|
| Transistor used in final stage | BFW16A | BFW16A | BFW16A | BFW16A | BFW16A | BFW16A | |
| driver stage | | BFW16A | BFW16A | | | BFW16A | |
| second stage | | | BFY90 | | | | |
| first stage | BFY90 | BFY90 | BFY90 | BFY90 | BFY90 | BFY90 | |
| Output power at $d_{im} = -30$ dB | 150 ²⁾ | 150 ²⁾ | 100 | | | | mW |
| $d_{im} = -50$ dB | | | | | 30 | | mW |
| $d_{im} = -60$ dB | | | | 10 | | 10 | mW |
| Power gain | 50 | 44 | 26.5 | 51 | 43 | 39 | dB |
| Noise figure | 7 | 6 | 8 | 6.0-6.5 | 6.5 | 6.5 | dB |
| V.S.W.R. over the whole channel or band | | | | | | | |
| for the input | < 2 | < 2 | < 2 | < 2 | < 2 | < 2 | |
| for the output | < 2 | < 2 | < 2 | < 2 | < 2 | < 2 | |
| Load impedance | 30 | 30 | 50 | 30 | 30 | 30 | Ω |
| Source impedance | 60 | 60 | 50 | 60 | 60 | 60 | Ω |

¹⁾ Application information bulletins of all these amplifiers and a study of inter-modulation are available on request.

²⁾ $V_o = 2.2$ V over $R_L = 30 \Omega$ or
 $V_o = 3$ V over $R_L = 60 \Omega$.

SILICON PLANAR EPITAXIAL TRANSISTOR

N-P-N multi-emitter transistor in a TO-39 metal envelope, with the collector connected to the case. The transistor has extreme good intermodulation properties and a high power gain. It is a ruggedized version of the BFW17, which it succeeds. It is primarily intended for final and driver stages of channel- and band aerial amplifiers with high output power for band I; II and III (40 - 230 MHz).

| QUICK REFERENCE DATA | | |
|---|------------|--------------|
| Collector-base voltage (open emitter; peak value) | V_{CBOM} | max. 40 V |
| Collector-emitter voltage (open base) | V_{CEO} | max. 25 V |
| Collector current (peak value; $f > 1$ MHz) | I_{CM} | max. 300 mA |
| Total power dissipation up to $T_{mb} = 125$ °C | P_{tot} | max. 1.5 W |
| Junction temperature | T_j | max. 200 °C |
| Feedback capacitance at $f = 1$ MHz $I_C = 10$ mA; $V_{CE} = 15$ V | C_{re} | typ. 1.7 pF |
| Transition frequency $I_C = 150$ mA; $V_{CE} = 15$ V; $f = 500$ MHz | f_T | typ. 1.1 GHz |
| Power gain (not neutralized) $I_C = 70$ mA; $V_{CE} = 18$ V; $f = 200$ MHz | G_p | typ. 16 dB |
| Output power $d_{im} = -30$ dB; V.S.W.R. at output < 2 $I_C = 70$ mA; $V_{CE} = 18$ V | P_o | typ. 150 mW |

MECHANICAL DATA

Dimensions in mm/

Collector connected to case

TO-39

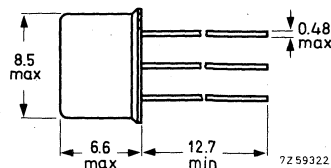
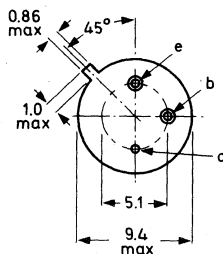

Accessories available: 56218; 56245,

RATINGS Limiting values in accordance with the Absolute Maximum System (IEC 134)

Voltages

| | | | |
|--|------------|------|--------------------|
| Collector-base voltage (open emitter; peak value) | V_{CBOM} | max. | 40 V |
| Collector-emitter voltage ($R_{BE} \leq 50 \Omega$) peak value | V_{CERM} | max. | 40 V ¹⁾ |
| Collector-emitter voltage (open base) | V_{CEO} | max. | 25 V ¹⁾ |
| Emitter-base voltage (open collector) | V_{EBO} | max. | 2 V |

Currents

| | | | |
|---|----------|------|--------|
| Collector current (d. c.) | I_C | max. | 150 mA |
| Collector current (peak value; $f > 1$ MHz) | I_{CM} | max. | 300 mA |

Power dissipation

| | | | |
|---|-----------|------|-------|
| Total power dissipation up to $T_{mb} = 125 \text{ }^\circ\text{C}$ | P_{tot} | max. | 1.5 W |
|---|-----------|------|-------|

Temperatures

| | | |
|----------------------|-----------|------------------------------|
| Storage temperature | T_{stg} | -65 to +200 $^\circ\text{C}$ |
| Junction temperature | T_j | max. 200 $^\circ\text{C}$ |

THERMAL RESISTANCE

| | | | |
|--|---------------|---|------------------------|
| From junction to ambient in free air | $R_{th j-a}$ | = | 250 $^\circ\text{C/W}$ |
| From junction to mounting base | $R_{th j-mb}$ | = | 50 $^\circ\text{C/W}$ |
| From mounting base to heatsink mounted with top clamping washer of 56218 and a boron nitride washer for electrical insulation | $R_{th mb-h}$ | = | 1.2 $^\circ\text{C/W}$ |

¹⁾ $I_C = 10 \text{ mA}$.

CHARACTERISTICS

$T_j = 25\text{ }^\circ\text{C}$ unless otherwise specified

Collector cut-off current

$I_E = 0; V_{CB} = 20\text{ V}; T_j = 150\text{ }^\circ\text{C}$

$I_{CBO} < 20\text{ }\mu\text{A}$

Knee voltage

$I_C = 100\text{ mA}; I_B = \text{value for which}$

$I_C = 110\text{ mA at } V_{CE} = 1\text{ V}$

$V_{CEK} < 0.75\text{ V}$

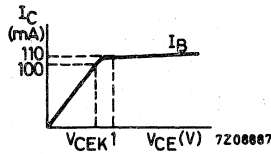

D.C. current gain

$I_C = 50\text{ mA}; V_{CE} = 5\text{ V}$

$h_{FE} > 25$

$I_C = 150\text{ mA}; V_{CE} = 5\text{ V}$

$h_{FE} > 25$

Transition frequency

$I_C = 150\text{ mA}; V_{CE} = 15\text{ V}; f = 500\text{ MHz}$

$f_T \text{ typ. } 1.1\text{ GHz}$

Collector capacitance at $f = 1\text{ MHz}$

$I_E = I_e = 0; V_{CB} = 15\text{ V}$

$C_c < 4\text{ pF}$

Feedback capacitance at $f = 1\text{ MHz}$

$I_C = 10\text{ mA}; V_{CE} = 15\text{ V}; T_{amb} = 25\text{ }^\circ\text{C}$

$C_{re} \text{ typ. } 1.7\text{ pF}$

Power gain (not neutralized)

$I_C = 70\text{ mA}; V_{CE} = 18\text{ V}$

$f = 200\text{ MHz}; T_{amb} = 25\text{ }^\circ\text{C}$

$G_p \text{ typ. } 16\text{ dB}$

CHARACTERISTICS (continued)

Intermodulation characteristics

1. Output power at $f = 200$ MHz; $T_{amb} = 25$ °C

$I_C = 70$ mA; $V_{CE} = 18$ V; V.S.W.R. at output < 2

$f_p = 202$ MHz; $f_q = 205$ MHz; $d_{im} = -30$ dB

measured at $f(2q-p) = 208$ MHz (Channel 9)

P_o typ. 150 mW

Test circuit:

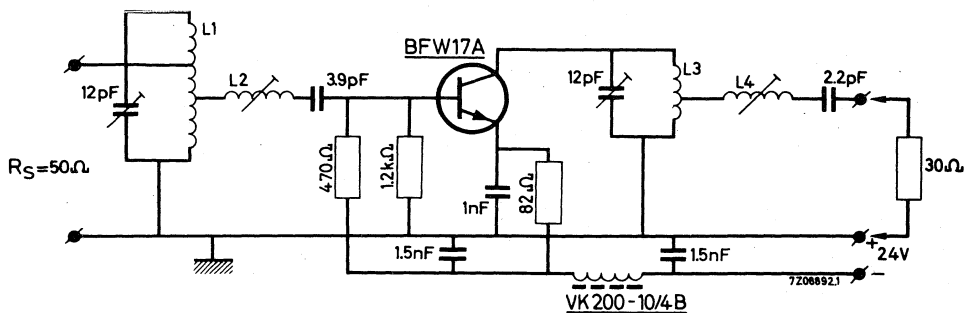

Coil data:

L1 = 3 turns silver plated Cu wire (1.4 mm); winding pitch 2.7 mm;
int. diam. 8 mm; taps at 0.5 turn and 1.5 turns from earth.

L2 = 5.5 turns silver plated Cu wire (1.4 mm); winding pitch 2.2 mm;
int. diam. 8 mm.

L3 = 3 turns silver plated Cu wire (1.4 mm); winding pitch 3.3 mm;
int. diam. 8 mm.

L4 = 5.5 turns silver plated Cu wire (1.4 mm); winding pitch 2.2 mm;
int. diam. 11 mm.

CHARACTERISTICS (continued)

Basis of adjustment

The intermodulation at an intermodulation distortion of -30 dB is caused by h.f. output current - voltage clipping.

The maximum undistorted output power is realised, if

- a. Current and voltage clipping take place concurrently.
This occurs if

$$R_L = \frac{V_{CE} - V_{CEK}}{I_C}$$

in which V_{CEK} is the high frequency knee voltage.

- b. The h.f. collector current is as small as possible.

This is so if $-C_L = +C_{Oe}$,

in which C_{Oe} is the output capacitance of the transistor at short circuited input.

For maximum output power at an intermodulation distortion of -30 dB, the (experimentally found) values of R_L and C_L are:

$$R_L = 220 \Omega; C_L = -5.6 \text{ pF.}$$

C_{Oe} is found by 4 pF of the transistor and 1.6 pF by the mounting system concerning of a borium nitride washer between the envelope of the transistor and the chassis.

Adjustment procedure

1. Remove the transistor and connect a dummy consisting of a 220 Ω resistor in parallel with a 5.6 pF capacitor between the collector and emitter connections of the output circuit.
2. Tune and match the output circuit for zero reflection at 205 MHz (V.S.W.R. = 1). After this adjustment, no further change may be made in the output circuit.
3. Replace the dummy by the transistor. Tune and match the input circuit for maximum power gain and good band pass curve.
The V.S.W.R. of the output will then, in most cases, be ≤ 2 over the whole channel.
Corrections can be made by tuning L_2 ; this will not disturb the band pass curve.

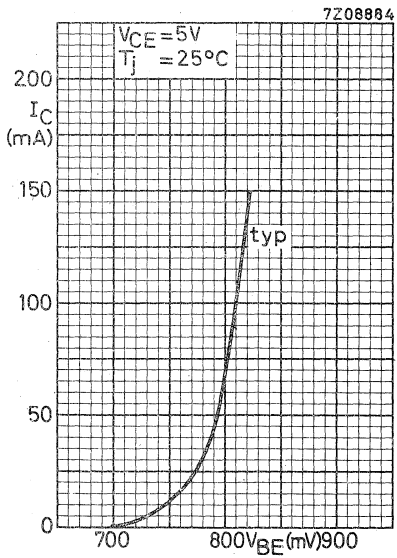
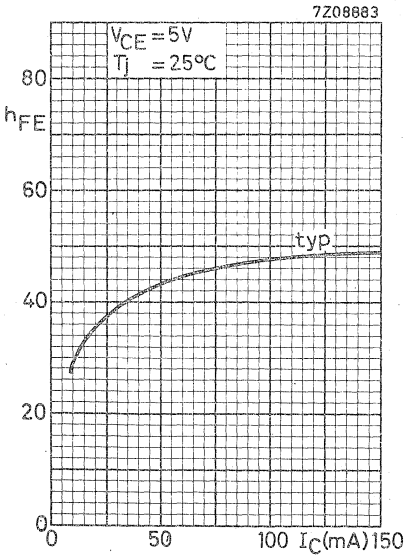
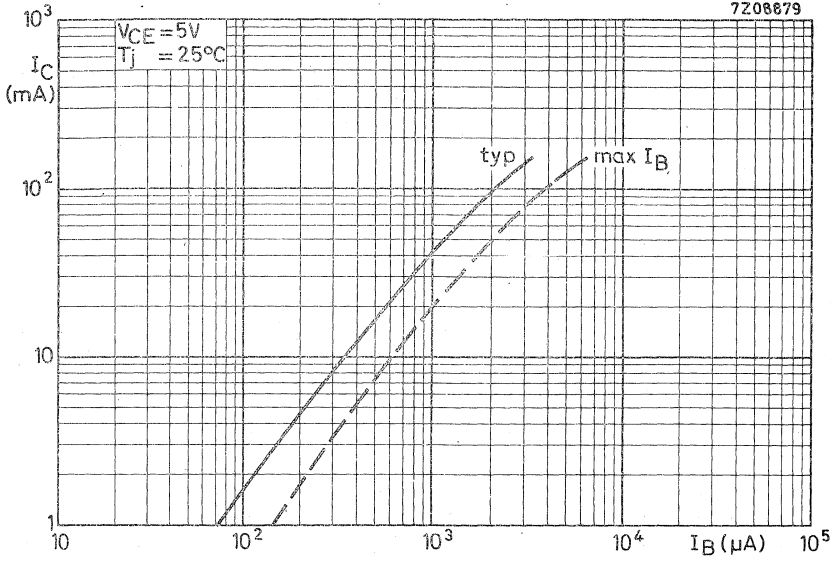

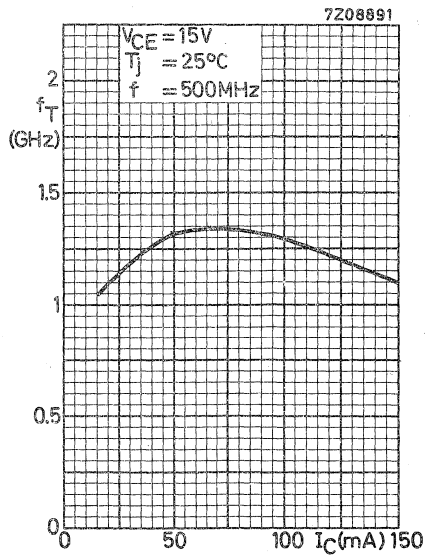
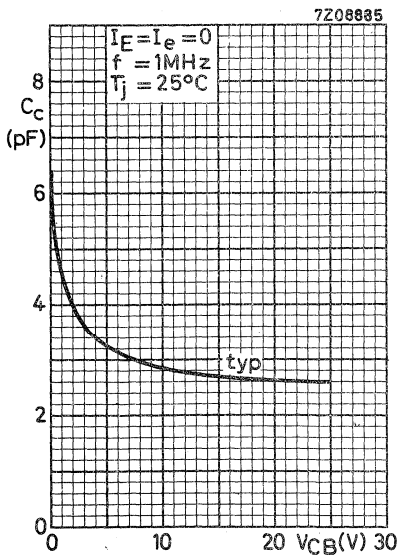
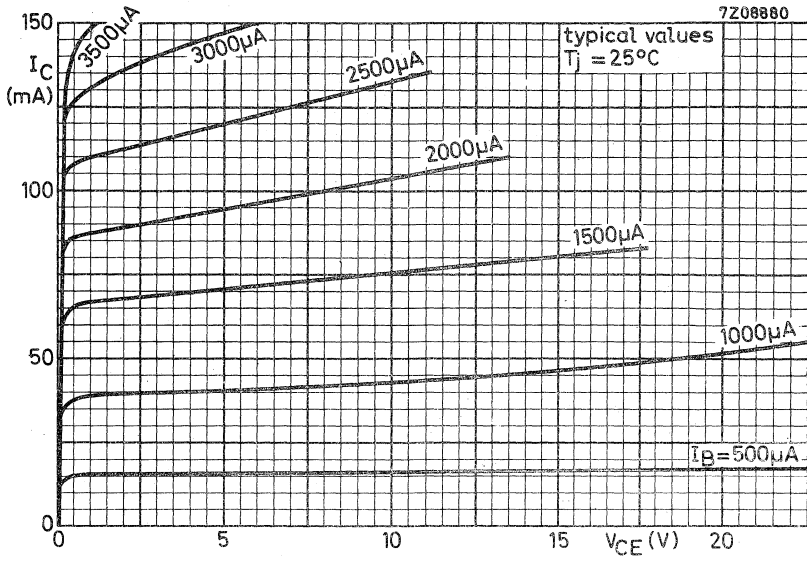

7208881

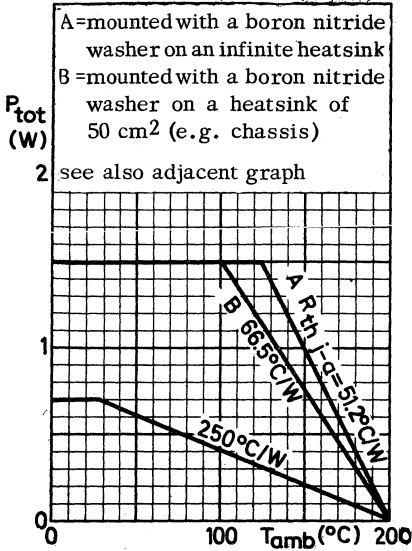

7208882

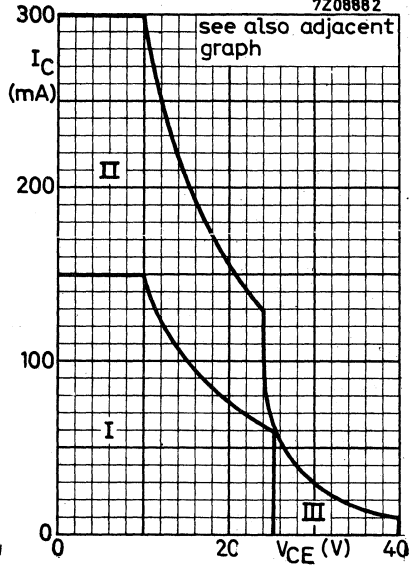

- I = Region of permissible operation under all base-emitter conditions and at all frequencies, including d.c.
- II = Additional region of operation at $f \geq 1$ MHz
- III = Operating under pulsed conditions is allowed, provided the transistor is cut-off with $R_{BE} \leq 50 \Omega$ and $f \geq 1$ MHz.

SILICON PLANAR EPITAXIAL TRANSISTOR

N-P-N multi-emitter transistor in a TO-72 metal envelope, with insulated electrodes and a shield lead connected to the case. The transistor has very low intermodulation distortion and very high power gain.

It is primarily intended for:

- Wideband vertical amplifiers in high speed oscilloscopes.
- Wideband aerial amplifiers (40-860 MHz)
- Television distribution amplifiers

| QUICK REFERENCE DATA | | | |
|---|------------|---------------------------------|-------------|
| Collector-base voltage (open emitter; peak value) | V_{CBOM} | max. | 20 V |
| Collector-emitter voltage (open base) | V_{CEO} | max. | 10 V |
| Collector current (peak value; $f > 1$ MHz) | I_{CM} | max. | 100 mA |
| Total power dissipation up to $T_{amb} = 25$ °C | P_{tot} | max. | 250 mW |
| Junction temperature | T_j | max. | 200 °C |
| Feedback capacitance at $f = 1$ MHz $I_C = 2$ mA; $V_{CE} = 5$ V | C_{re} | typ. | 0.8 pF |
| Transition frequency $I_C = 50$ mA; $V_{CE} = 5$ V; $f = 500$ MHz | f_T | typ. | 1.6 GHz |
| Power gain (not neutralized) $I_C = 30$ mA; $V_{CE} = 5$ V | G_p | $f = 200 \quad \quad 800$ MHz | |
| | | typ. | 21 7.5 dB |
| Intermodulation distortion $I_C = 30$ mA; $V_{CE} = 6$ V; $R_L = 37.5 \Omega$ $V_o = 100$ mV at $f_p = 183$ MHz $V_o = 100$ mV at $f_q = 200$ MHz measured at $f(2q-p) = 217$ MHz | d_{im} | typ. | -60 dB |

MECHANICAL DATA

Dimensions in mm

TO-72

insulated electrodes

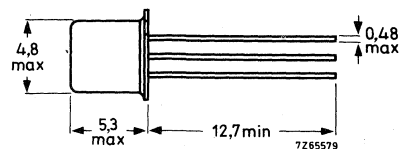
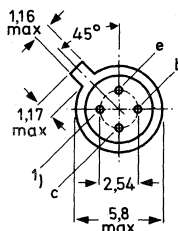

1) = shield lead (connected to case)

Accessories available: 56246; 56263

RATINGS Limiting values in accordance with the Absolute Maximum System (IEC 134)VoltagesCollector-base voltage (open emitter; peak value) V_{CBOM} max. 20 V

Collector-emitter voltage (open base)

 $I_C = 10 \text{ mA}$ V_{CEO} max. 10 V

Emitter-base voltage (open collector)

 V_{EBO} max. 2.5 VCurrents

Collector current (d.c.)

 I_C max. 50 mACollector current (peak value; $f > 1 \text{ MHz}$) I_{CM} max. 100 mAPower dissipationTotal power dissipation up to $T_{amb} = 25 \text{ }^\circ\text{C}$ P_{tot} max. 250 mWTemperatures

Storage temperature

 T_{stg} -65 to +200 $^\circ\text{C}$

Junction temperature

 T_j max. 200 $^\circ\text{C}$ **THERMAL RESISTANCE**

From junction to ambient in free air

 $R_{th j-a} = 0.7 \text{ }^\circ\text{C/mW}$

From junction to case

 $R_{th j-c} = 0.5 \text{ }^\circ\text{C/mW}$

CHARACTERISTICS

$T_j = 25\text{ }^\circ\text{C}$ unless otherwise specified

Collector cut-off current

$I_E = 0; V_{CB} = 10\text{ V}$

$I_{CBO} < 50\text{ nA}$

D.C. current gain

$I_C = 25\text{ mA}; V_{CE} = 5\text{ V}$

$h_{FE} > 25$

$I_C = 50\text{ mA}; V_{CE} = 5\text{ V}$

$h_{FE} > 25$

Transition frequency ¹⁾

$I_C = 50\text{ mA}; V_{CE} = 5\text{ V}; f = 500\text{ MHz}$

f_T typ. 1.6 GHz

Collector capacitance at $f = 1\text{ MHz}$ ²⁾

$I_E = I_e = 0; V_{CB} = 5\text{ V}$

$C_c < 1.5\text{ pF}$

Feedback capacitance at $f = 1\text{ MHz}$ ¹⁾

$I_C = 2\text{ mA}; V_{CE} = 5\text{ V}$

C_{re} typ. 0.8 pF

Noise figure ¹⁾

$I_C = 2\text{ mA}; V_{CE} = 5\text{ V}$

$f = 500\text{ MHz}; R_S = 50\text{ }\Omega$

$F < 5\text{ dB}$

Power gain (not neutralized) ¹⁾

$I_C = 30\text{ mA}; V_{CE} = 5\text{ V}; T_{amb} = 25\text{ }^\circ\text{C}$

| | | | |
|-------|-----------|-------|-----|
| | $f = 200$ | 800 | MHz |
| G_p | > 19 | | dB |
| | typ. 21 | 7.5 | dB |

Intermodulation distortion ¹⁾

$I_C = 30\text{ mA}; V_{CE} = 6\text{ V}; R_L = 37.5\text{ }\Omega; T_{amb} = 25\text{ }^\circ\text{C}$

$V_o = 100\text{ mV}$ at $f_p = 183\text{ MHz}$

$V_o = 100\text{ mV}$ at $f_q = 200\text{ MHz}$
measured at $f(2q-p) = 217\text{ MHz}$

dim typ. -60 dB

Test circuit

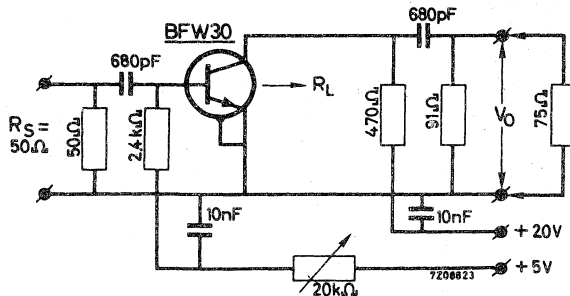

- 1) Shield lead grounded.
- 2) Shield lead not connected.

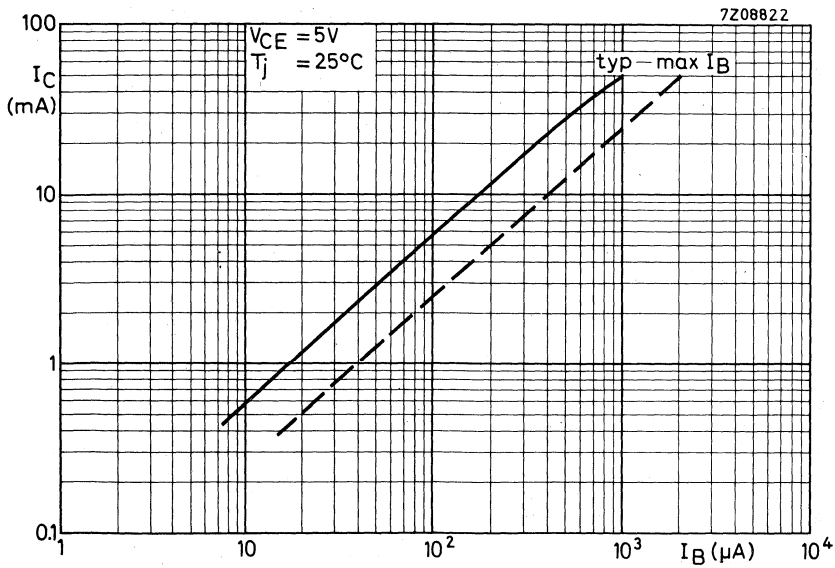
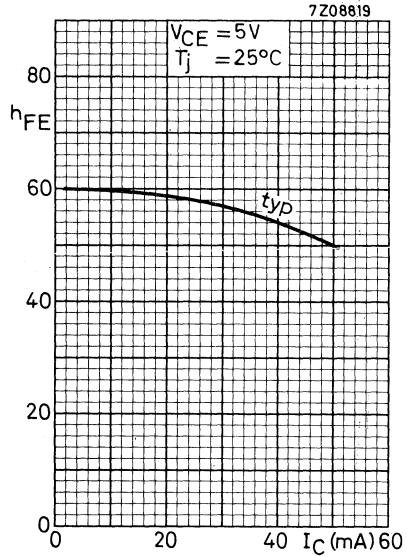
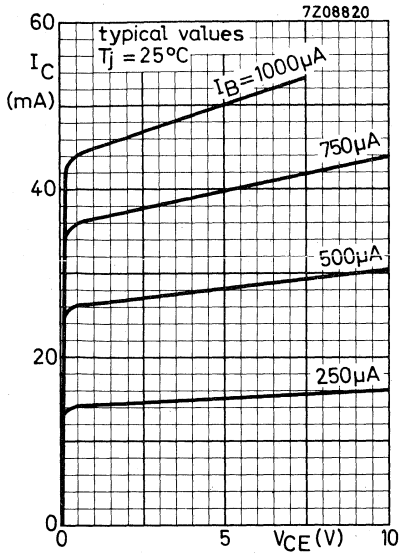

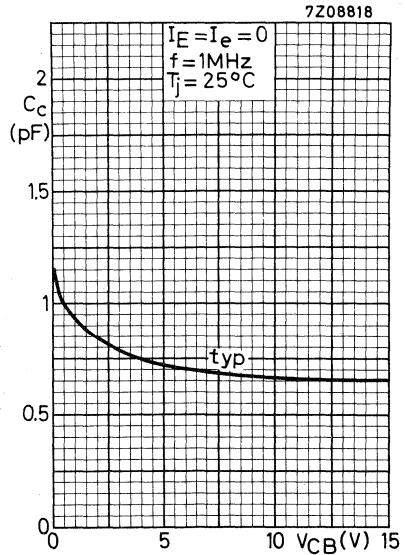
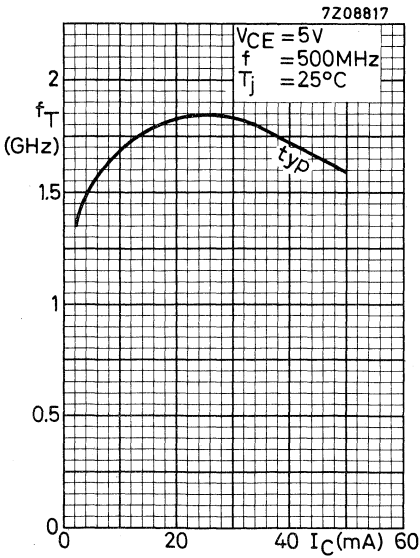
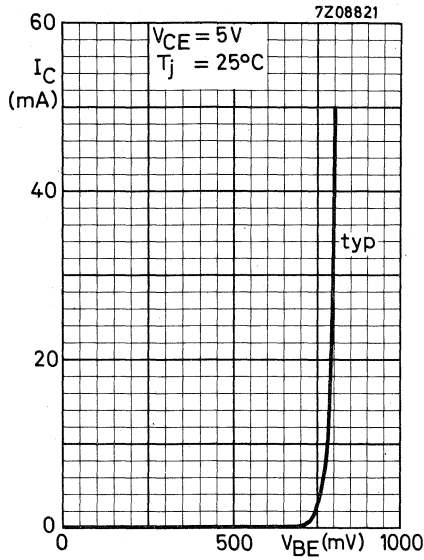

SILICON PLANAR TRANSISTOR

N-P-N transistor in a TO-39 metal envelope with the collector connected to the case. The BFW45 is primarily intended for the output stage of the horizontal deflection amplifier in wide band oscilloscopes.

QUICK REFERENCE DATA

| | | |
|--|-----------|-----------------------------|
| Collector-base voltage (open emitter) | V_{CBO} | max. 165 V |
| Collector-emitter voltage (open base) | V_{CEO} | max. 130 V |
| Collector current (peak value) | I_{CM} | max. 100 mA |
| Total power dissipation up to $T_{mb} = 150\text{ }^{\circ}\text{C}$ | P_{tot} | max. 2.5 W |
| Junction temperature | T_j | max. 200 $^{\circ}\text{C}$ |
| D.C. current gain $I_C = 50\text{ mA}; V_{CE} = 20\text{ V}$ | h_{FE} | 20 to 120 |
| Transition frequency at $f = 100\text{ MHz}$ $I_C = 10\text{ mA}; V_{CE} = 10\text{ V}$ | f_T | > 80 MHz typ. 120 MHz |
| Feedback capacitance at $f = 1\text{ MHz}$ $I_C = 10\text{ mA}; V_{CE} = 20\text{ V}$ | C_{re} | < 3.5 pF |

MECHANICAL DATA

Dimensions in mm

TO-39

Collector connected to case

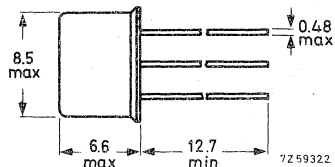
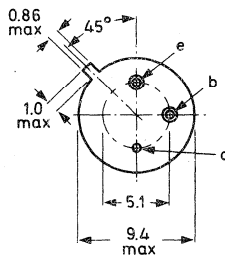

Accessories available: 56218, 56245

RATINGS (Limiting values) 1)Voltages

| | | | |
|---------------------------------------|-----------|------|-------|
| Collector-base voltage (open emitter) | V_{CBO} | max. | 165 V |
| Collector-emitter voltage (open base) | V_{CEO} | max. | 130 V |
| Emitter-base voltage (open collector) | V_{EBO} | max. | 5 V |

Currents

| | | | |
|--------------------------------|----------|------|--------|
| Collector current (d.c.) | I_C | max. | 50 mA |
| Collector current (peak value) | I_{CM} | max. | 100 mA |

Power dissipation

| | | | | |
|-------------------------------|--|-----------|------|-------|
| Total power dissipation up to | $T_{amb} = 40\text{ }^{\circ}\text{C}$ | P_{tot} | max. | 0.8 W |
| | $T_{mb} = 150\text{ }^{\circ}\text{C}$ | P_{tot} | max. | 2.5 W |

Temperatures

| | | | |
|----------------------|-----------|-------------|------------------------|
| Storage temperature | T_{stg} | -55 to +200 | $^{\circ}\text{C}$ |
| Junction temperature | T_j | max. | 200 $^{\circ}\text{C}$ |

THERMAL RESISTANCE

| | | | |
|--------------------------------------|----------------|---|------------------------------------|
| From junction to ambient in free air | $R_{th\ j-a}$ | = | 200 $^{\circ}\text{C}/\text{W}$ |
| From junction to mounting base | $R_{th\ j-mb}$ | = | 20 $^{\circ}\text{C}/\text{W}^2$) |
| From junction to case | $R_{th\ j-c}$ | = | 25 $^{\circ}\text{C}/\text{W}^2$) |

1) Limiting values according to the Absolute Maximum System as defined in IEC publication 134.

2) See also page 8.

CHARACTERISTICS

$T_j = 25\text{ }^\circ\text{C}$ unless otherwise specified

Collector cut-off current

| | | | |
|---|-----------|---|------------------|
| $I_E = 0; V_{CB} = 100\text{ V}$ | I_{CBO} | < | 100 nA |
| $I_E = 0; V_{CB} = 100\text{ V}; T_j = 150\text{ }^\circ\text{C}$ | I_{CBO} | < | 10 μA |

Base-emitter voltage ¹⁾

| | | | |
|--|----------|---|-------|
| $I_C = 50\text{ mA}; V_{CE} = 20\text{ V}$ | V_{BE} | < | 1.3 V |
|--|----------|---|-------|

High frequency knee voltage at $T_j = 120\text{ }^\circ\text{C}$

| | | | |
|----------------------|-----------|---|------|
| $I_C = 50\text{ mA}$ | V_{CEK} | < | 27 V |
|----------------------|-----------|---|------|

The high frequency knee voltage of a transistor is that value of the collector-emitter voltage at which the small signal gain, measured in a practical circuit, has dropped to 80% of the gain at $V_{CE} = 50\text{ V}$. A further decrease of the collector-emitter voltage results in a rapid increase of the distortion of the signal.

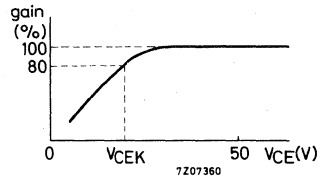
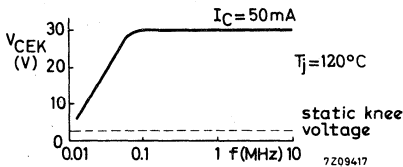

Collector-emitter saturation voltage

| | | | |
|---|-------------|---|------|
| $I_C = 10\text{ mA}; I_B = 1\text{ mA}$ | V_{CEsat} | < | 3 V |
| $I_C = 50\text{ mA}; I_B = 5\text{ mA}$ | V_{CEsat} | < | 10 V |

D.C. current gain

| | | | |
|--|----------|-------|-----|
| $I_C = 50\text{ mA}; V_{CE} = 20\text{ V}$ | h_{FE} | 20 to | 120 |
|--|----------|-------|-----|

Feedback capacitance at $f = 1\text{ MHz}$

| | | | |
|--|----------|---|--------|
| $I_C = 10\text{ mA}; V_{CE} = 20\text{ V}$ | C_{re} | < | 3.5 pF |
|--|----------|---|--------|

Collector capacitance at $f = 1\text{ MHz}$

| | | | |
|---------------------------------------|-------|---|------|
| $I_E = I_e = 0; V_{CB} = 20\text{ V}$ | C_C | < | 6 pF |
|---------------------------------------|-------|---|------|

Transition frequency at $f = 100\text{ MHz}$

| | | | |
|--|-------|------|---------|
| $I_C = 10\text{ mA}; V_{CE} = 10\text{ V}$ | f_T | > | 80 MHz |
| | | typ. | 120 MHz |

¹⁾ V_{BE} decreases by about 1.6 mV/ $^\circ\text{C}$ with increasing temperature.

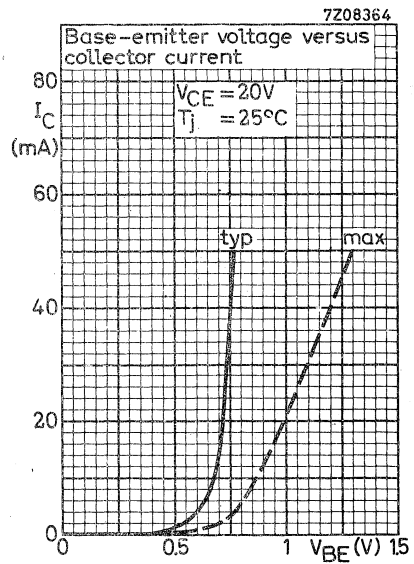
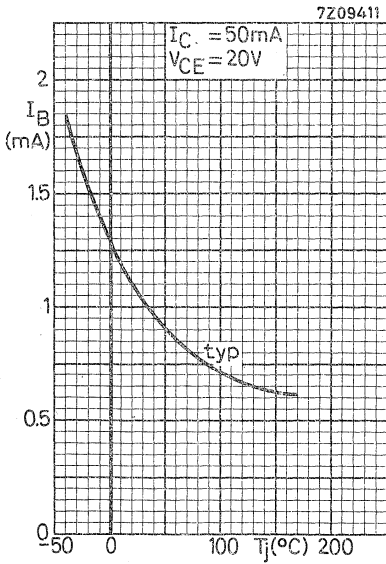
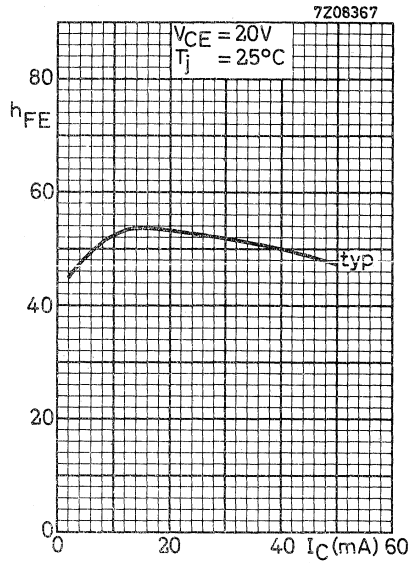
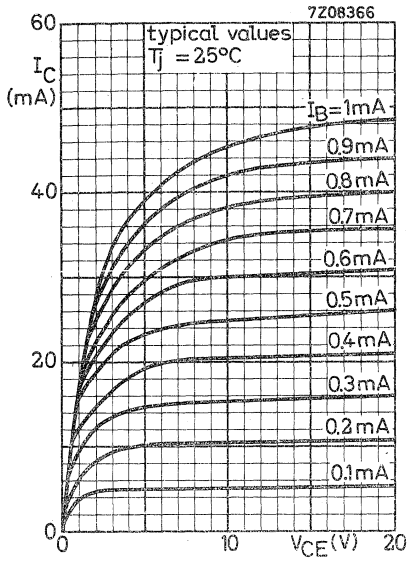

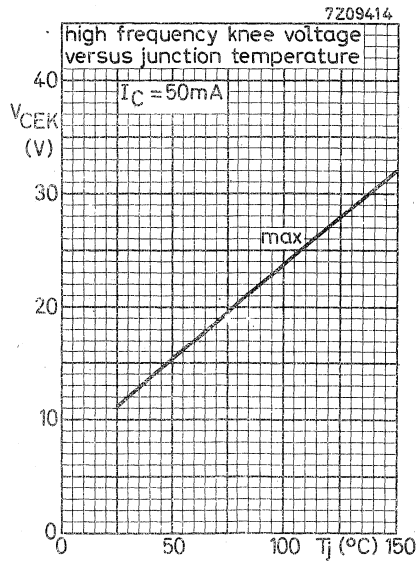
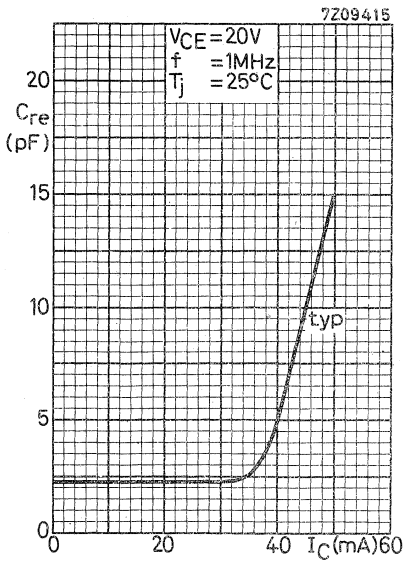
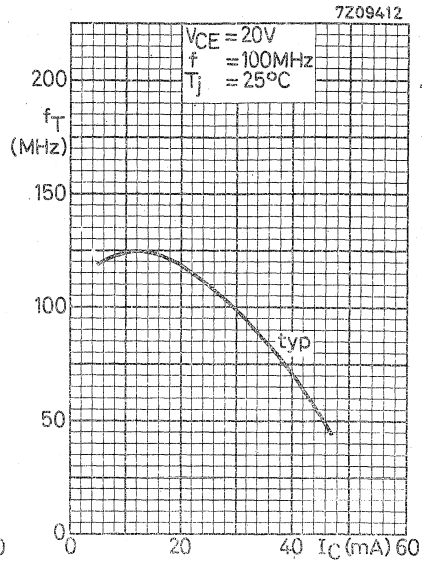
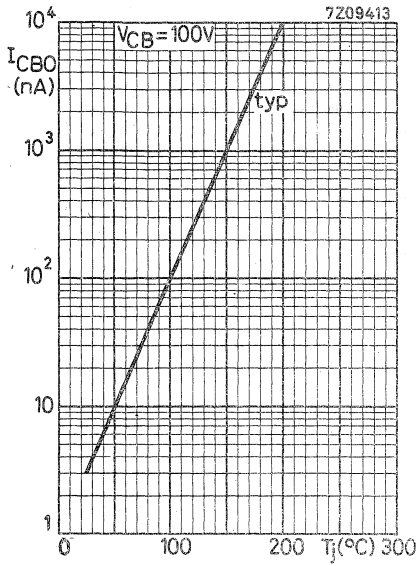

7209416

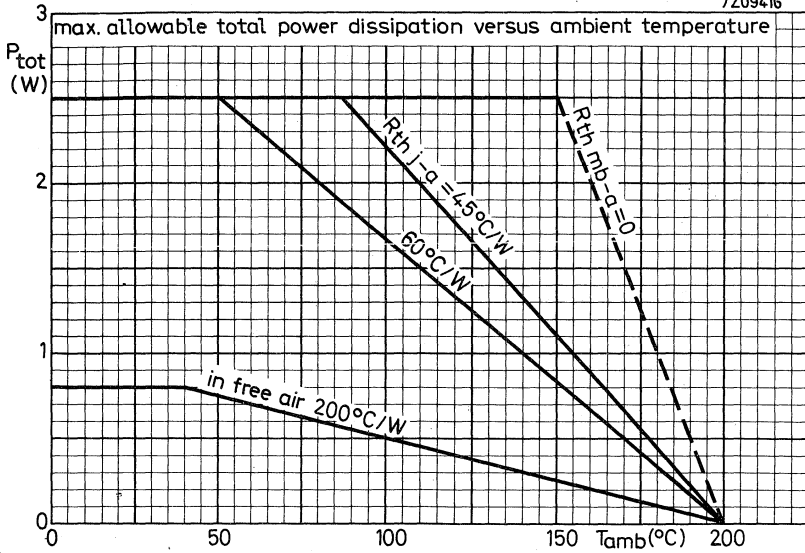

7208756

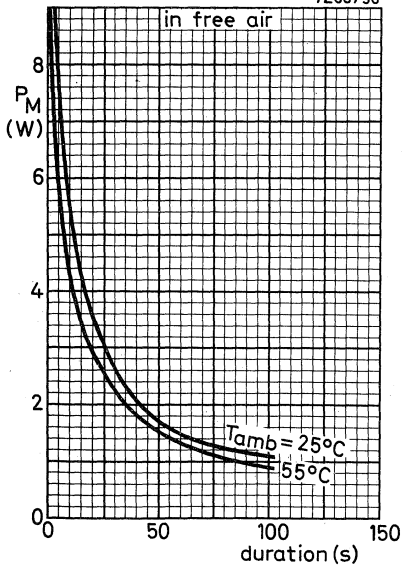

7208757

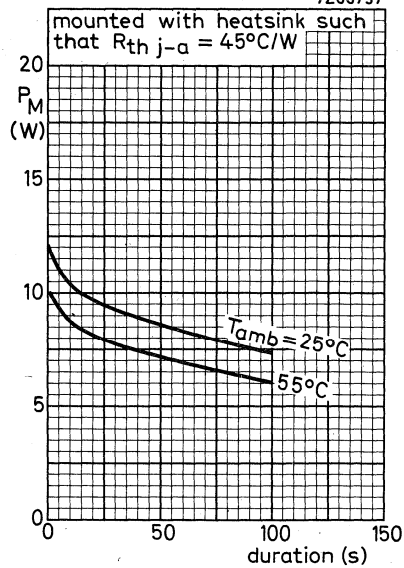

maximum allowable peak power dissipation versus duration

SILICON PLANAR EPITAXIAL TRANSISTOR

N-P-N transistor in a subminiature plastic T-package. It has a low noise over a wide current range, a very high power gain and good intermodulation properties.

It is primarily intended for:

- Wideband aerial amplifiers (40 - 860 MHz)
- Channel and band aerial amplifiers for band I, II, III and IV/V (40 - 860 MHz)
- Television distribution amplifiers
- Low noise wideband vertical amplifier in high speed oscilloscopes

QUICK REFERENCE DATA

| | | | | |
|---|------------|------|-----|-----|
| Collector-base voltage (open emitter; peak value) | V_{CBOM} | max. | 25 | V |
| Collector-emitter voltage (open base) | V_{CEO} | max. | 15 | V |
| Collector current (peak value; $f > 1$ MHz) | I_{CM} | max. | 50 | mA |
| Total power dissipation up to $T_{amb} = 73$ °C | P_{tot} | max. | 190 | mW |
| Junction temperature | T_j | max. | 150 | °C |
| Transition frequency at $f = 500$ MHz | f_T | typ. | 1,6 | GHz |
| $I_C = 25$ mA; $V_{CE} = 5$ V | | | | |
| Feedback capacitance at $f = 1$ MHz | C_{re} | typ. | 0,6 | pF |
| $I_C = 2$ mA; $V_{CE} = 5$ V | | | | |
| Noise figure at $f = 500$ MHz | F | typ. | 4 | dB |
| $I_C = 2$ mA; $V_{CE} = 5$ V | | | | |
| Power gain (not neutralized) | | | | |
| $I_C = 10$ mA; $V_{CE} = 10$ V; $T_{amb} = 25$ °C | G_p | typ. | 23 | 11 |
| Output power at $d_{im} = -30$ dB | | | | |
| VSWR at output < 2 ; $I_C = 10$ mA; $V_{CE} = 10$ V | P_o | typ. | 8 | 8 |
| | | | | mW |

MECHANICAL DATA

SOT-37

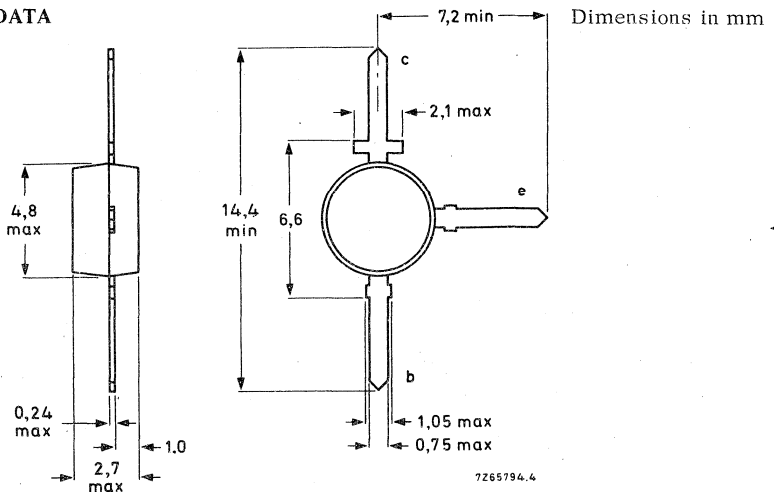

RATINGS Limiting values in accordance with the Absolute Maximum System (IEC 134)

Voltages

| | | | |
|---|------------|------|---------|
| Collector-base voltage (open emitter; peak value) | V_{CBOM} | max. | 25 V |
| Collector-emitter voltage (open base) | V_{CEO} | max. | 15 V 1) |
| Emitter-base voltage (open collector) | V_{EBO} | max. | 2.5 V |

Currents

| | | | |
|---|----------|------|-------|
| Collector current (d. c.) | I_C | max. | 25 mA |
| Collector current (peak value; $f > 1$ MHz) | I_{CM} | max. | 50 mA |

Power dissipation

| | | | |
|---|-----------|------|--------|
| Total power dissipation up to $T_{amb} = 73$ °C | P_{tot} | max. | 190 mW |
|---|-----------|------|--------|

Temperatures

| | | |
|----------------------|-----------|----------------|
| Storage temperature | T_{stg} | -65 to +150 °C |
| Junction temperature | T_j | max. 150 °C |

THERMAL RESISTANCE

From junction to ambient in free air
 mounted on a glass-fibre print *)
 of 40 mm x 25 mm x 1 mm

$$R_{th\ j-a} = 0.4 \text{ °C/mW}$$

*) Requirements for glass-fibre print

(dimensions in mm)

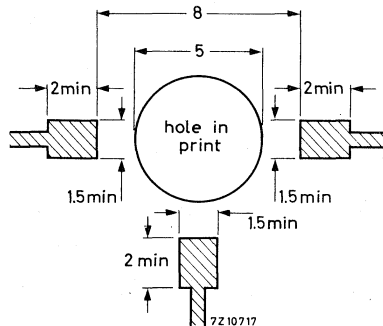

1) At $I_C = 10$ mA

CHARACTERISTICS

$T_j = 25\text{ }^\circ\text{C}$ unless otherwise specified

Collector cut-off current

$I_E = 0; V_{CB} = 10\text{ V}$

$I_{CBO} < 50\text{ nA}$

Knee voltage ¹⁾

$I_C = 20\text{ mA}; I_B = \text{value for which}$

$I_C = 22\text{ mA at } V_{CE} = 1\text{ V}$

$V_{CEK} < 0.75\text{ V}$

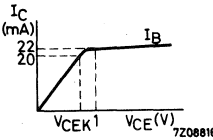

D. C. current gain

$I_C = 2\text{ mA}; V_{CE} = 1\text{ V}$

$h_{FE} > 20$
 $h_{FE} < 150$

$I_C = 25\text{ mA}; V_{CE} = 1\text{ V}^1)$

$h_{FE} > 20$

Transition frequency at $f = 500\text{ MHz}$

$I_C = 2\text{ mA}; V_{CE} = 5\text{ V}$

$f_T \text{ typ. } 1.0\text{ GHz}$

$I_C = 25\text{ mA}; V_{CE} = 5\text{ V}^1)$

$f_T \text{ typ. } 1.6\text{ GHz}$

Collector capacitance at $f = 1\text{ MHz}$

$I_E = I_e = 0; V_{CB} = 10\text{ V}$

$C_c \text{ typ. } 0.7\text{ pF}$

Emitter capacitance at $f = 1\text{ MHz}$

$I_C = I_c = 0; V_{EB} = 0.5\text{ V}$

$C_e \text{ typ. } 1.5\text{ pF}$

Feedback capacitance at $f = 1\text{ MHz}$

$I_C = 2\text{ mA}; V_{CE} = 5\text{ V}; T_{amb} = 25\text{ }^\circ\text{C}$

$C_{re} \text{ typ. } 0.6\text{ pF}$

Noise figure at $f = 500\text{ MHz}$

$I_C = 2\text{ mA}; V_{CE} = 5\text{ V}; R_S = 50\text{ }^\Omega; T_{amb} = 25\text{ }^\circ\text{C}$

$F \text{ typ. } 4.0\text{ dB}$

Power gain (not neutralized)

$I_C = 10\text{ mA}; V_{CE} = 10\text{ V}; T_{amb} = 25\text{ }^\circ\text{C}$

| | | | |
|-------|-----------|-------|--------------|
| | $f = 200$ | 800 | MHz |
| G_p | typ. 23 | .11 | dB |

¹⁾ Measured under pulsed conditions.

CHARACTERISTICS (continued) $T_j = 25\text{ }^\circ\text{C}$ unless otherwise specifiedIntermodulation characteristics1. Output power at $f = 200\text{ MHz}$; $T_{\text{amb}} = 25\text{ }^\circ\text{C}$ $I_C = 10\text{ mA}$; $V_{CE} = 10\text{ V}$; V. S. W. R. at output < 2 $f_p = 202\text{ MHz}$; $f_q = 205\text{ MHz}$; $d_{\text{im}} = -30\text{ dB}$ measured at $f(2q-p) = 208\text{ MHz}$ (Channel 9) P_o typ. 8 mW

Test circuit:

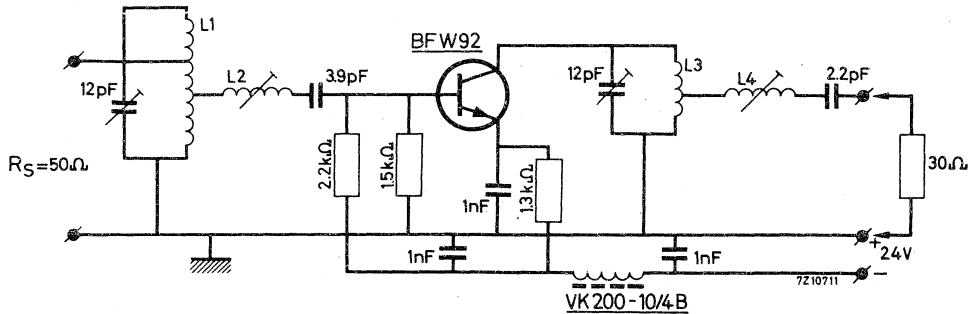

Coil data:

- L1 = 3 turns silver plated Cu wire (1.4 mm); winding pitch 2.7 mm;
int. diam. 8 mm; taps at 0.5 turn and 1.5 turns from earth.
- L2 = 5.5 turns silver plated Cu wire (1.4 mm); winding pitch 2.2 mm;
int. diam. 8 mm.
- L3 = 3 turns silver plated Cu wire (1.4 mm); winding pitch 3.3 mm;
int. diam. 8 mm.
- L4 = 5.5 turns silver plated Cu wire (1.4 mm); winding pitch 2.2 mm;
int. diam. 11 mm.

CHARACTERISTICS (continued)

Basis of adjustment

The intermodulation at an intermodulation distortion of -30 dB is caused by h.f. output current - voltage clipping.

The maximum undistorted output power is realised, if

- a. Current and voltage clipping take place concurrently.

This occurs if

$$R_L = \frac{V_{CE} - V_{CEK}}{I_C},$$

in which V_{CEK} is the high frequency knee voltage.

- b. The h.f. collector current is as small as possible.

This is so if $-C_L = +C_{Oe}$,

in which C_{Oe} is the output capacitance of the transistor at short circuited input.

For maximum output power at an intermodulation distortion of -30 dB, the (experimentally found) values of R_L and C_L are:

$$R_L = 820 \Omega; C_L = -1.0 \text{ pF}$$

Adjustment procedure

1. Remove the transistor and connect a dummy consisting of a 820 Ω resistor in parallel with a 1.0 pF capacitor between the collector and emitter connections of the output circuit.
2. Tune and match the output circuit for zero reflection at 205 MHz (V.S.W.R. = 1). After this adjustment, no further change may be made in the output circuit.
3. Replace the dummy by the transistor. Tune and match the input circuit for maximum power gain and good band pass curve.
The V.S.W.R. of the output will then, in most cases, be ≤ 2 over the whole channel.
Corrections can be made by tuning L2; this will not disturb the band pass curve.

CHARACTERISTICS (continued)

$T_j = 25\text{ }^\circ\text{C}$ unless otherwise specified

Intermodulation characteristics

2. Output power at $f = 800\text{ MHz}$; $T_{\text{amb}} = 25\text{ }^\circ\text{C}$

$I_C = 10\text{ mA}$; $V_{CE} = 10\text{ V}$; V. S. W. R. at output < 2

$f_p = 798\text{ MHz}$; $f_q = 802\text{ MHz}$; $d_{im} = -30\text{ dB}$

measured at $f_{(2q-p)} = 806\text{ MHz}$ (Channel 62)

P_o typ. 8 mW

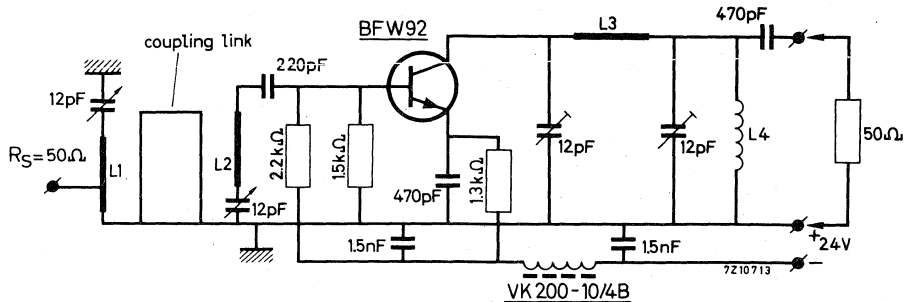

Coil data:

L1 = 24 mm x 6 mm x 0.5 mm silver plated Cu strip.

Tap of the input at 5 mm from earth.

L2 = 15 mm x 6 mm x 0.5 mm silver plated Cu strip.

L3 = 20 mm x 8 mm x 0.5 mm silver plated Cu strip.

L4 = 4 turns enamelled Cu wire (0.5 mm); winding pitch 1.5 mm; int. diam. 4 mm

Coupling link: 42 mm silver plated Cu wire (1 mm).

Basis of adjustment.

At 800 MHz no dummy can be used to adjust for optimum collector load because at these frequencies the impedance transformations of a dummy are too high. A small signal at the mid-channel frequency of 802 MHz is fed to the input and increased until clipping occurs; that is, until the output power no longer increases linearly with the input signal. This clipping can be eliminated by tuning the output circuit, thereby making the output power equal to

$$P_o = \frac{I_C (V_{CE} - V_{CEK})}{2} = 40\text{ mW}$$

The output circuit is adjusted for minimum intermodulation if the input signal is as small as possible at $P_o = 40\text{ mW}$.

After this adjustment has been made no further change may be made in the output circuit.

Adjust the input circuit for maximum power gain and good band pass curve.

The V. S. W. R. of the output is then ≤ 2 over the whole channel.

CHARACTERISTICS (continued)

Intermodulation characteristics

3. Intermodulation distortion

$I_C = 10 \text{ mA}$; $V_{CE} = 6 \text{ V}$; $R_L = 37.5 \Omega$; $T_{amb} = 25^\circ\text{C}$

$V_0 = 100 \text{ mV}$ at $f_p = 183 \text{ MHz}$

$V_0 = 100 \text{ mV}$ at $f_q = 200 \text{ MHz}$
 measured at $f_{(2q-p)} = 217 \text{ MHz}$

d_{im} typ. -45 dB

Test circuit:

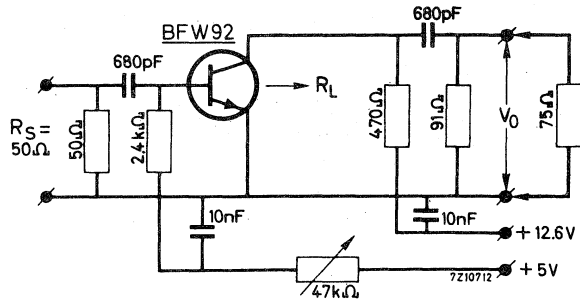

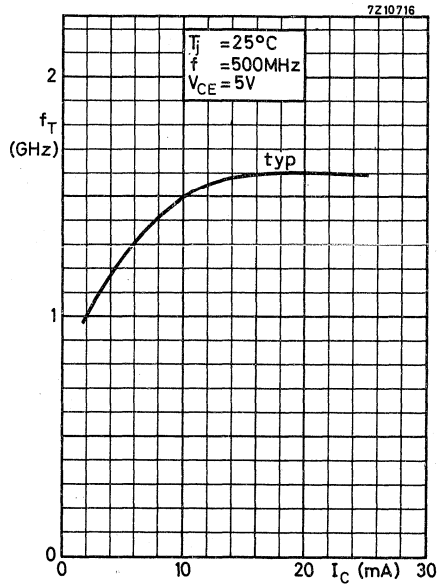

00000
00000
00000
00000
00000
00000

SILICON PLANAR EPITAXIAL TRANSISTOR

N-P-N transistor in a subminiature plastic transfer-moulded T-package.

The device is intended for use in v. h. f. - u. h. f. applications, primarily wideband aerial amplifiers 40 - 800 MHz.

It is intended for mounting on miniature printed-circuit boards.

QUICK REFERENCE DATA

| | | | | |
|--|-----------|------|------|-----|
| Collector-base voltage (open emitter) | V_{CBO} | max. | 18 | V |
| Collector-emitter voltage (open base) | V_{CEO} | max. | 10 | V |
| Collector current (peak value; $f > 1$ MHz) | I_{CM} | max. | 100 | mA |
| Total power dissipation up to $T_{amb} = 73$ °C | P_{tot} | max. | 190 | mW |
| Junction temperature | T_j | max. | 150 | °C |
| Feedback capacitance at $f = 1$ MHz $I_C = 2$ mA; $V_{CE} = 5$ V; $T_{amb} = 25$ °C | C_{re} | typ. | 0,6 | pF |
| Transition frequency at $f = 500$ MHz $I_C = 50$ mA; $V_{CE} = 5$ V | f_T | typ. | 1,7 | GHz |
| Max. unilateral power gain (see page 3) $I_C = 30$ mA; $V_{CE} = 5$ V; $f = 200$ MHz; $T_{amb} = 25$ °C | G_{UM} | typ. | 22 | dB |
| $I_C = 30$ mA; $V_{CE} = 5$ V; $f = 800$ MHz; $T_{amb} = 25$ °C | G_{UM} | typ. | 10,5 | dB |
| Intermodulation distortion at $T_{amb} = 25$ °C $I_C = 30$ mA; $V_{CE} = 5$ V; $R_L = 37,5$ Ω | | | | |
| $V_O = 100$ mV at $f_p = 183$ MHz | | | | |
| $V_O = 100$ mV at $f_q = 200$ MHz | | | | |
| measured at $f(2q - p) = 217$ MHz | d_{im} | typ. | -60 | dB |

MECHANICAL DATA

SOT-37

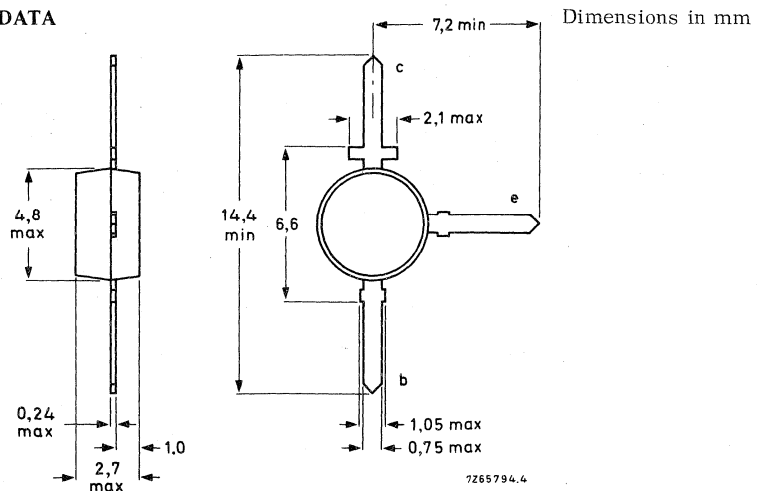

RATINGS Limiting values in accordance with the Absolute Maximum System (IEC134)

Voltages

| | | | | |
|---------------------------------------|-----------|------|-----|---|
| Collector-base voltage (open emitter) | V_{CBO} | max. | 18 | V |
| Collector-emitter voltage (open base) | V_{CEO} | max. | 10 | V |
| Emitter-base voltage (open collector) | V_{EBO} | max. | 2.5 | V |

Currents

| | | | | |
|---|----------|------|-----|----|
| Collector current (d. c.) | I_C | max. | 50 | mA |
| Collector current (peak value; $f > 1$ MHz) | I_{CM} | max. | 100 | mA |

Power dissipation

| | | | | |
|---|-----------|------|-----|----|
| Total power dissipation up to $T_{amb} = 73$ °C | P_{tot} | max. | 190 | mW |
|---|-----------|------|-----|----|

Temperatures

| | | | |
|----------------------|-----------|-------------|--------|
| Storage temperature | T_{stg} | -65 to +150 | °C |
| Junction temperature | T_j | max. | 150 °C |

THERMAL RESISTANCE

From junction to ambient in free air
mounted on a glass-fibre print
of 40 mm x 25 mm x 1 mm

$$R_{th\ j-a} = 0.4 \text{ °C/mW}$$

Requirements for glass-fibre print
(dimensions in mm)

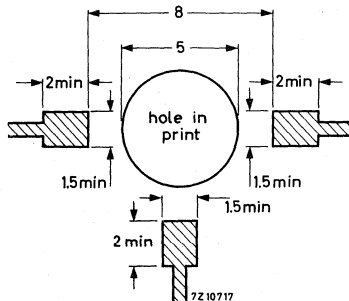

CHARACTERISTICS

$T_j = 25\text{ }^\circ\text{C}$ unless otherwise specified

Collector cut-off current

$I_E = 0; V_{CB} = 10\text{ V}$ $I_{CBO} < 50\text{ nA}$

D. C. current gain ¹⁾

$I_C = 25\text{ mA}; V_{CE} = 5\text{ V}$ $h_{FE} > 25$

$I_C = 50\text{ mA}; V_{CE} = 5\text{ V}$ $h_{FE} > 25$

Transition frequency at $f = 500\text{ MHz}$ ¹⁾

$I_C = 50\text{ mA}; V_{CE} = 5\text{ V}$ f_T typ. 1.7 GHz

Collector capacitance at $f = 1\text{ MHz}$

$I_E = I_e = 0; V_{CB} = 5\text{ V}$ C_c typ. 0.7 pF

Emitter capacitance at $f = 1\text{ MHz}$

$I_C = I_c = 0; V_{EB} = 0.5\text{ V}$ C_e typ. 1.5 pF

Feedback capacitance at $f = 1\text{ MHz}$

$I_C = 2\text{ mA}; V_{CE} = 5\text{ V}; T_{amb} = 25\text{ }^\circ\text{C}$ C_{re} typ. 0.6 pF

Noise figure at $f = 500\text{ MHz}$

$I_C = 2\text{ mA}; V_{CE} = 5\text{ V}; G_S = 20\text{ mA/V}$
 B_S is tuned; $T_{amb} = 25\text{ }^\circ\text{C}$ $F < 5\text{ dB}$

Max. unilateral power gain (s_{re} assumed to be zero)

$$G_{UM} \text{ (in dB)} = 10 \log \frac{|s_{fe}|^2}{(1 - |s_{ie}|^2)(1 - |s_{oe}|^2)}$$

$I_C = 30\text{ mA}; V_{CE} = 5\text{ V}; f = 200\text{ MHz}; T_{amb} = 25\text{ }^\circ\text{C}$ G_{UM} typ. 22 dB

$I_C = 30\text{ mA}; V_{CE} = 5\text{ V}; f = 800\text{ MHz}; T_{amb} = 25\text{ }^\circ\text{C}$ G_{UM} typ. 10.5 dB

¹⁾ Measured under pulse conditions.

CHARACTERISTICS (continued)

Intermodulation distortion at $T_{amb} = 25\text{ }^{\circ}\text{C}$

$I_C = 30\text{ mA}$; $V_{CE} = 5\text{ V}$; $R_L = 37.5\text{ }\Omega$

$V_O = 100\text{ mV}$ at $f_p = 183\text{ MHz}$

$V_O = 100\text{ mV}$ at $f_q = 200\text{ MHz}$

measured at $f(2q - p) = 217\text{ MHz}$

d_{im} typ. -60 dB

Test circuit :

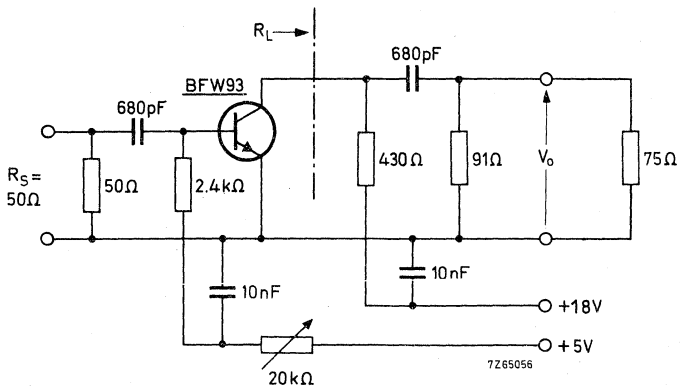

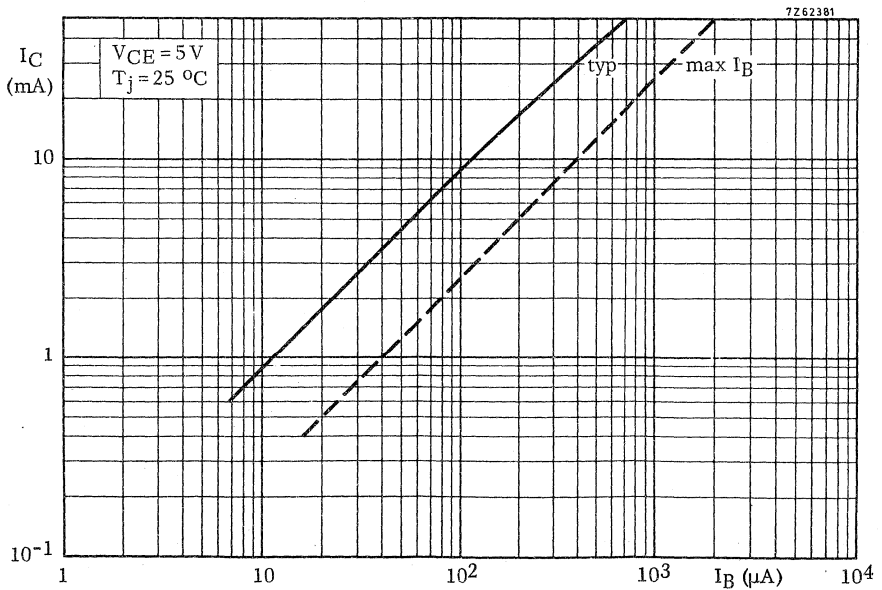
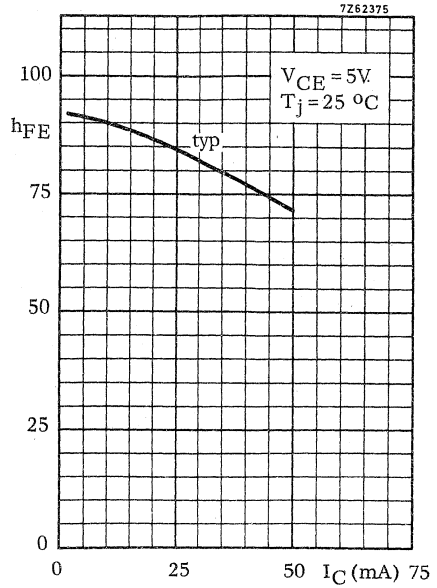
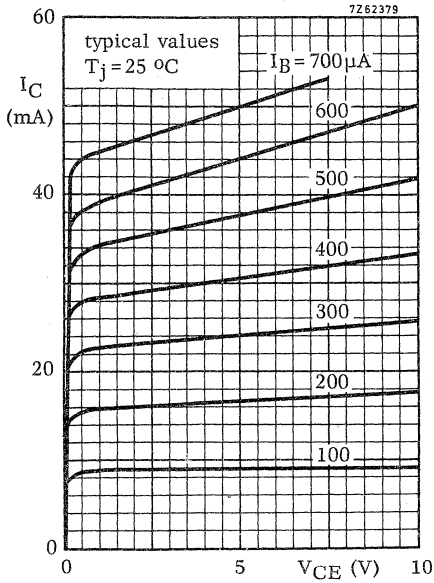

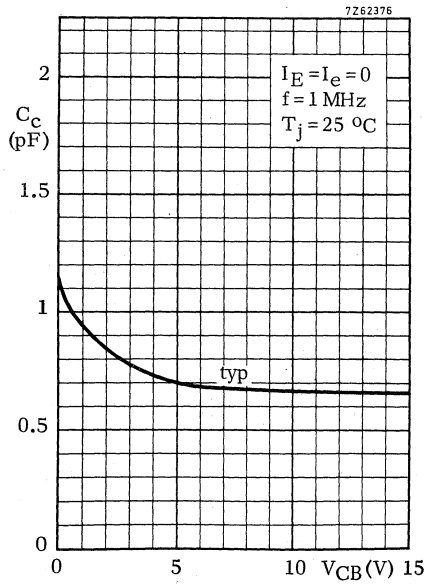
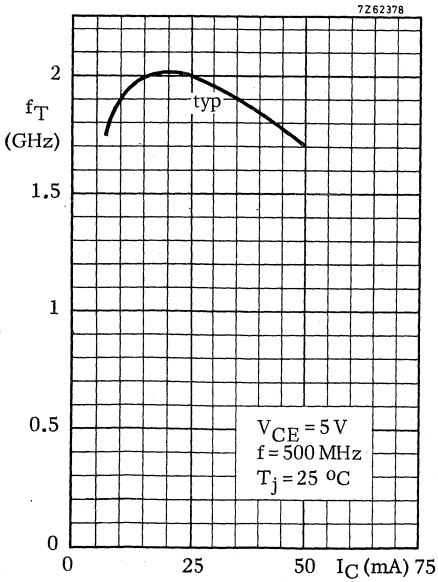
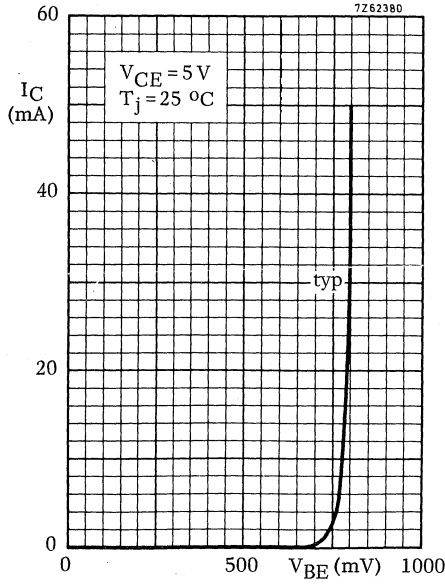

circles of constant noise figure

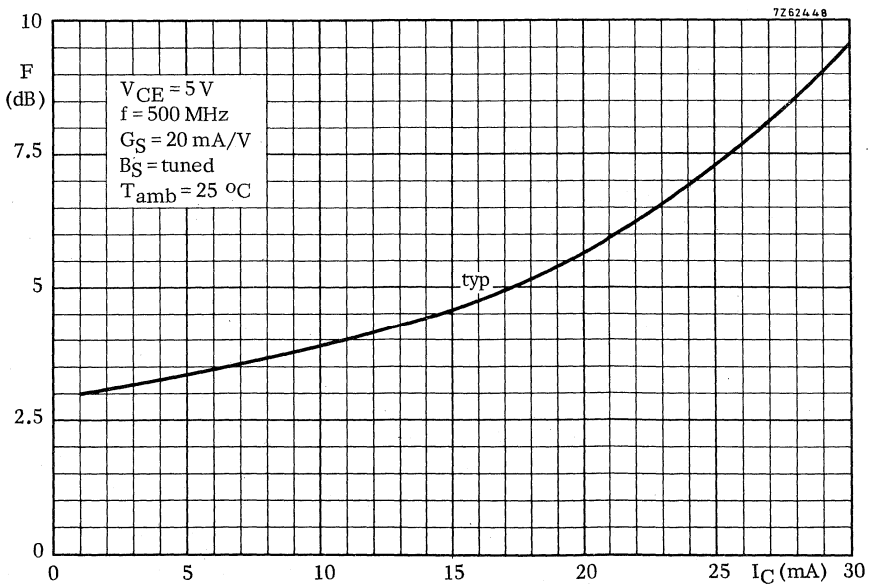
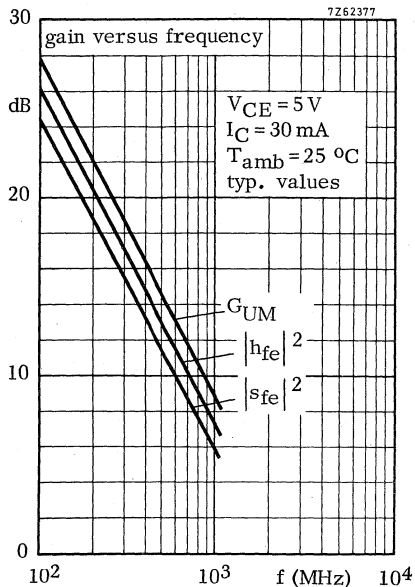
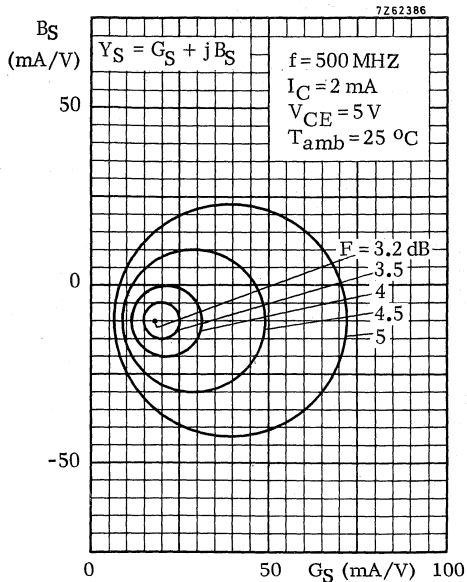

$V_{CE} = 5\text{ V}$
 $I_C = 30\text{ mA}$
 $T_{amb} = 25\text{ }^\circ\text{C}$

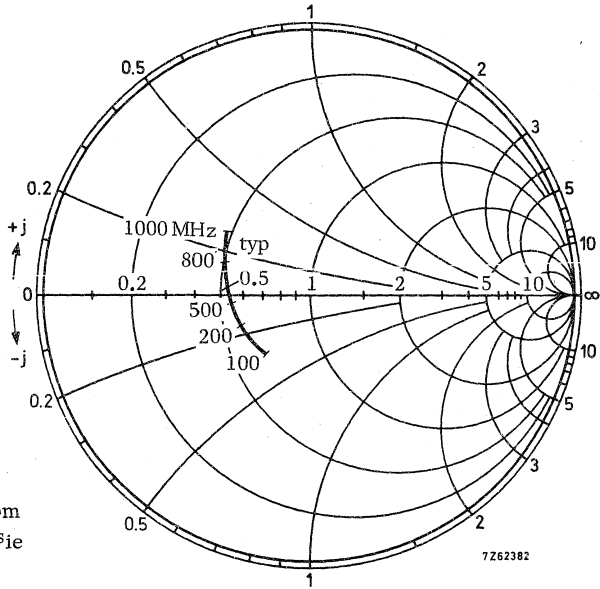

Input impedance derived from
input reflection coefficient s_{ie}
coordinates in ohm x 50

$V_{CE} = 5\text{ V}$
 $I_C = 30\text{ mA}$
 $T_{amb} = 25\text{ }^\circ\text{C}$

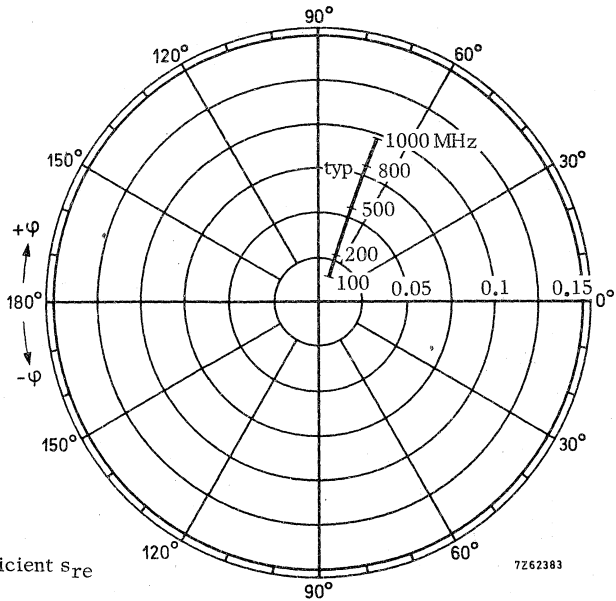

Reverse transmission coefficient s_{re}

$V_{CE} = 5 \text{ V}$
 $I_C = 30 \text{ mA}$
 $T_{amb} = 25 \text{ }^\circ\text{C}$

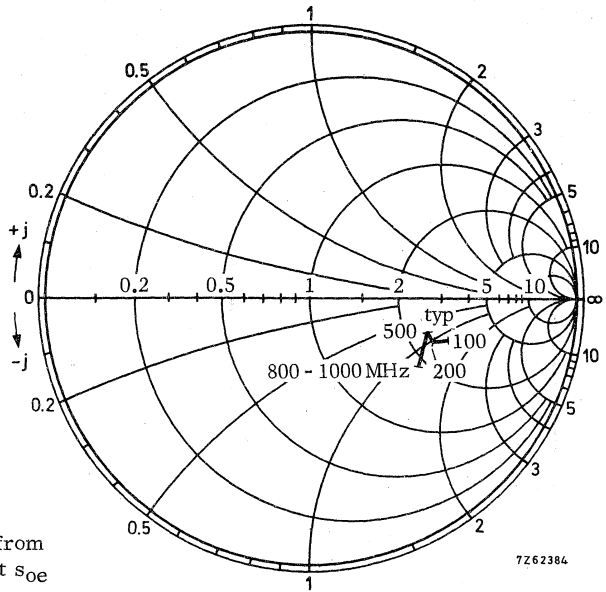

Output impedance derived from output reflection coefficient s_{oe} coordinates in ohm x 50

$V_{CE} = 5 \text{ V}$
 $I_C = 30 \text{ mA}$
 $T_{amb} = 25 \text{ }^\circ\text{C}$

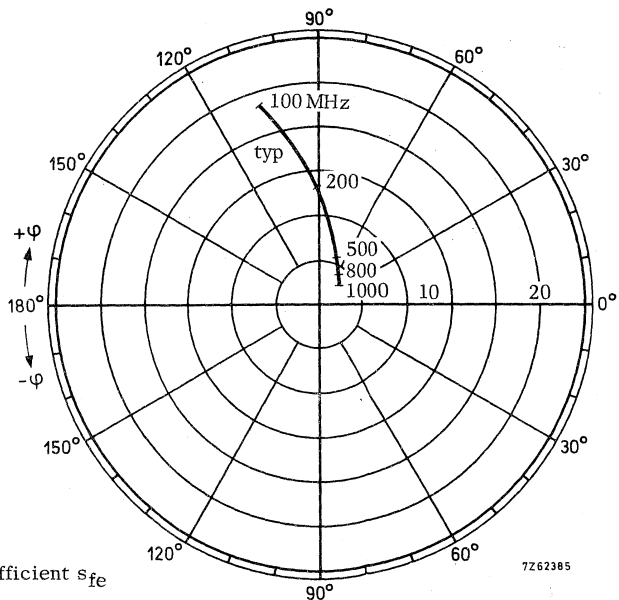

Forward transmission coefficient s_{fe}

SILICON PLANAR EPITAXIAL TRANSISTOR

N-P-N transistor in a TO-72 metal envelope, with insulated electrodes and a shield lead connected to the case.

The transistor has a low noise, a very high power gain and good intermodulation properties.

It is primarily intended for:

- Channel aerial amplifiers for band I, II, III and IV/V (40-860 MHz)
- Wide band aerial amplifiers (40-860 MHz).

| QUICK REFERENCE DATA | | | |
|--|------------|---------------|----------|
| Collector-base voltage (open emitter; peak value) | V_{CBOM} | max. | 30 V |
| Collector-emitter voltage (open base) | V_{CEO} | max. | 15 V |
| Collector current (peak value; $f > 1$ MHz) | I_{CM} | max. | 50 mA |
| Total power dissipation up to $T_{amb} = 25$ °C | P_{tot} | max. | 200 mW |
| Junction temperature | T_j | max. | 200 °C |
| Transition frequency $I_C = 25$ mA; $V_{CE} = 5$ V; $f = 500$ MHz | f_T | typ. | 1.2 GHz |
| Feedback capacitance $I_C = 2$ mA; $V_{CE} = 5$ V; $f = 1$ MHz | C_{re} | typ. | 0.6 pF |
| Noise figure at optimum source impedance $I_C = 2$ mA; $V_{CE} = 5$ V | F | $f = 200$ MHz | typ. 3.3 |
| | | 800 MHz | 7 dB |
| Power gain (not neutralized) $I_C = 8$ mA; $V_{CE} = 10$ V | G_p | $f = 200$ MHz | typ. 22 |
| | | 800 MHz | 7 dB |
| Output power $d_{im} = -30$ dB; V.S.W.R. at output < 2 $I_C = 8$ mA; $V_{CE} = 10$ V | P_o | typ. | 6 mW |

MECHANICAL DATA

Dimensions in mm

TO-72
insulated electrodes

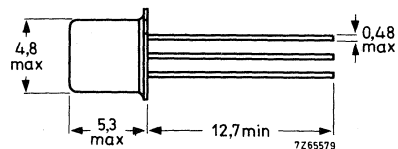
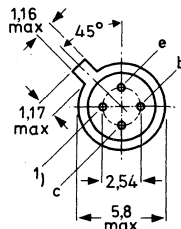

1) = shield lead (connected to case)

Accessories available: 56246, 56263

RATINGS Limiting values in accordance with the Absolute Maximum System (IEC 134)

Voltages

| | | | |
|--|------------|------|--------------------|
| Collector-base voltage (open emitter; peak value) | V_{CBOM} | max. | 30 V |
| Collector-emitter voltage (peak value) $R_{BE} \leq 50 \Omega$ | V_{CERM} | max. | 30 V ¹⁾ |
| Collector-emitter voltage (open base) | V_{CEO} | max. | 15 V ¹⁾ |
| Emitter-base voltage (open collector) | V_{EBO} | max. | 2.5 V |

Currents

| | | | |
|---|----------|------|-------|
| Collector current (d.c.) | I_C | max. | 25 mA |
| Collector current (peak value; $f > 1$ MHz) | I_{CM} | max. | 50 mA |

Power dissipation

| | | | |
|---|-----------|------|--------|
| Total power dissipation up to $T_{amb} = 25 \text{ }^\circ\text{C}$ | P_{tot} | max. | 200 mW |
|---|-----------|------|--------|

Temperatures

| | | | |
|----------------------|-----------|-------------|----------------------|
| Storage temperature | T_{stg} | -65 to +200 | $^\circ\text{C}$ |
| Junction temperature | T_j | max. | 200 $^\circ\text{C}$ |

THERMAL RESISTANCE

| | | | |
|--------------------------------------|--------------|---|---------------------------------|
| From junction to ambient in free air | $R_{th j-a}$ | = | 0.88 $^\circ\text{C}/\text{mW}$ |
| From junction to case | $R_{th j-c}$ | = | 0.58 $^\circ\text{C}/\text{mW}$ |

¹⁾ $I_C = 10$ mA.

CHARACTERISTICS

$T_j = 25\text{ }^\circ\text{C}$ unless otherwise specified

Collector cut-off current

$$I_E = 0; V_{CB} = 15\text{ V}$$

$$I_{CBO} < 10\text{ nA}$$

Knee voltage

$$I_C = 20\text{ mA}; I_B = \text{value for which}$$

$$I_C = 22\text{ mA at } V_{CE} = 1\text{ V}$$

$$V_{CEK} < 0.75\text{ V}$$

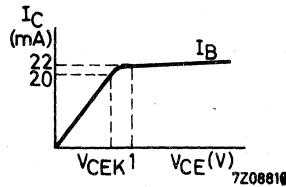

D.C. current gain

$$I_C = 2\text{ mA}; V_{CE} = 1\text{ V}$$

$$h_{FE} \quad 20\text{ to }150$$

$$I_C = 25\text{ mA}; V_{CE} = 1\text{ V}$$

$$h_{FE} \quad 20\text{ to }125$$

Transition frequency ¹⁾

$$I_C = 2\text{ mA}; V_{CE} = 5\text{ V}; f = 500\text{ MHz}$$

$$f_T \quad \text{typ. } 1.0\text{ GHz}$$

$$I_C = 25\text{ mA}; V_{CE} = 5\text{ V}; f = 500\text{ MHz}$$

$$f_T \quad \text{typ. } 1.2\text{ GHz}$$

Collector capacitance at $f = 1\text{ MHz}$ ²⁾

$$I_E = I_e = 0; V_{CB} = 10\text{ V}$$

$$C_c < 1.7\text{ pF}$$

Feedback capacitance at $f = 1\text{ MHz}$ ¹⁾

$$I_C = 2\text{ mA}; V_{CE} = 5\text{ V}$$

$$C_{re} \quad \text{typ. } 0.6\text{ pF}$$

Noise figure ¹⁾

$$I_C = 2\text{ mA}; V_{CE} = 5\text{ V}$$

$$f = 200\text{ MHz}; \text{ optimum source impedance}$$

$$F < 4\text{ dB}$$

$$f = 500\text{ MHz}; R_S = 50\text{ } \Omega$$

$$F < 6.5\text{ dB}$$

$$f = 800\text{ MHz}; \text{ optimum source impedance}$$

$$F \quad \text{typ. } 7.0\text{ dB}$$

Power gain (not neutralized) ¹⁾

$$I_C = 8\text{ mA}; V_{CE} = 10\text{ V}; T_{amb} = 25\text{ }^\circ\text{C}$$

| | | f = 200 | 800 | MHz |
|-------|------|---------|-----|-----|
| G_p | > | 19 | - | dB |
| | typ. | 22 | 7 | dB |

¹⁾ Shield lead grounded.

²⁾ Shield lead not connected.

CHARACTERISTICS (continued)

$T_j = 25\text{ }^\circ\text{C}$ unless otherwise specified

Intermodulation characteristics 1)

1. Output power at $f = 200\text{ MHz}$; $T_{\text{amb}} = 25\text{ }^\circ\text{C}$

$I_C = 8\text{ mA}$; $V_{CE} = 10\text{ V}$; V.S.W.R. at output < 2
 $f_p = 202\text{ MHz}$; $f_q = 205\text{ MHz}$; $d_{\text{im}} = -30\text{ dB}$
 measured at $f(2q-p) = 208\text{ MHz}$ (Channel 9)

P_o typ. 6 mW

Test circuit:

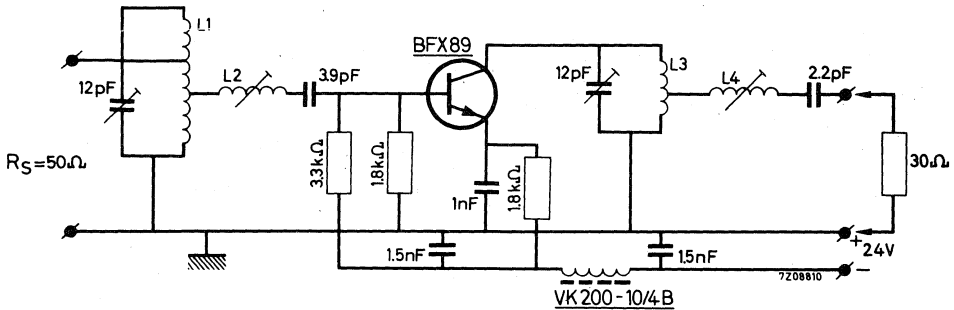

Coil data:

- L1 = 3 turns silver plated Cu wire (1.4 mm); winding pitch 2.7 mm;
int. diam. 8 mm; taps at 0.5 turn and 1.5 turns from earth.
- L2 = 5.5 turns silver plated Cu wire (1.4 mm); winding pitch 2.2 mm;
int. diam. 8 mm.
- L3 = 3 turns silver plated Cu wire (1.4 mm) winding pitch 3.3 mm;
int. diam. 8 mm.
- L4 = 5.5 turns silver plated Cu wire (1.4 mm) winding pitch 2.2 mm;
int. diam. 11 mm.

1) Shield lead grounded.

CHARACTERISTICS (continued)

Basis of adjustment

The intermodulation at an intermodulation distortion of -30 dB is caused by h.f. output current - voltage clipping.

The maximum undistorted output power is realised, if

- a. Current and voltage clipping take place concurrently.

This occurs if

$$R_L = \frac{V_{CE} - V_{CEK}}{I_C},$$

in which V_{CEK} is the high frequency knee voltage.

- b. The h.f. collector current is as small as possible.

This is so if $-C_L = +C_{Oe}$,

in which C_{Oe} is the output capacitance of the transistor at short circuited input.

For maximum output power at an intermodulation distortion of -30 dB, the (experimentally found) values of R_L and C_L are:

$R_L = 1 \text{ k}\Omega$; $C_L = -1.8 \text{ pF}$

Adjustment procedure

1. Remove the transistor and connect a dummy consisting of a $1 \text{ k}\Omega$ resistor in parallel with a 1.8 pF capacitor between the collector and emitter connections of the output circuit.
2. Tune and match the output circuit for zero reflection at 205 MHz (V.S.W.R. = 1). After this adjustment, no further change may be made in the output circuit.
3. Replace the dummy by the transistor. Tune and match the input circuit for maximum power gain and good band pass curve.
The V.S.W.R. of the output will then, in most cases, be ≤ 2 over the whole channel.
Corrections can be made by tuning L_2 ; this will not disturb the band pass curve.

CHARACTERISTICS (continued)

$T_j = 25\text{ }^\circ\text{C}$ unless otherwise specified

Intermodulation characteristics ¹⁾

2. Output power at $f = 800\text{ MHz}$; $T_{\text{amb}} = 25\text{ }^\circ\text{C}$

$I_C = 8\text{ mA}$; $V_{CE} = 10\text{ V}$; V.S.W.R. at output < 2

$f_p = 798\text{ MHz}$; $f_q = 802\text{ MHz}$; $d_{\text{im}} = -30\text{ dB}$

measured at $f(2q-p) = 806\text{ MHz}$ (Channel 62)

P_o typ. 6 mW

Test circuit:

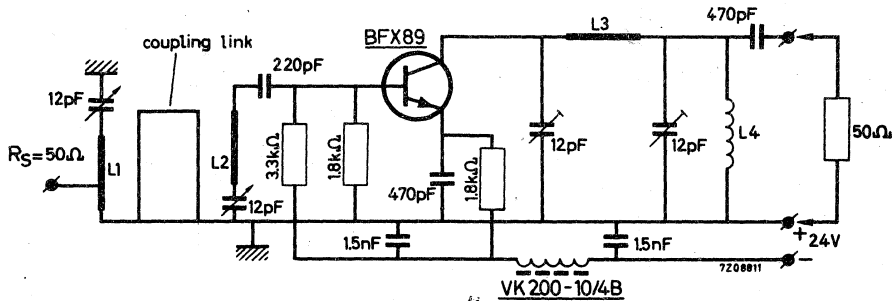

Coil data:

L1 = 24 mm x 6 mm x 0.5 mm silver plated Cu strip.

Tap of the input at 5 mm from earth.

L2 = 15 mm x 6 mm x 0.5 mm silver plated Cu strip.

L3 = 20 mm x 8 mm x 0.5 mm silver plated Cu strip.

L4 = 4 turns enamelled Cu wire (0.5 mm); winding pitch 1.5 mm;
int. diam. 4 mm.

Coupling link: 42 mm silver plated Cu wire (1 mm).

Basis of adjustment

At 800 MHz no dummy can be used to adjust for optimum collector load because at these frequencies the impedance transformations of a dummy are too high. A small signal at the mid-channel frequency of 802 MHz is fed to the input and increased until clipping occurs; that is, until the output power no longer increases linearly with the input signal. This clipping can be eliminated by tuning the output circuit, thereby making the output power equal to

$$P_o = \frac{I_C (V_{CE} - V_{CEK})}{2} = 35\text{ mW}$$

The output circuit is adjusted for minimum intermodulation if the input signal is as small as possible at $P_o = 35\text{ mW}$.

After this adjustment has been made no further change may be made in the output circuit.

Adjust the input circuit for maximum power gain and good band pass curve.

The V.S.W.R. of the output is then ≤ 2 over the whole channel.

¹⁾ Shield lead grounded

CHARACTERISTICS (continued)

$T_j = 25\text{ }^\circ\text{C}$ unless otherwise specified

Intermodulation characteristics ¹⁾

3. Intermodulation distortion

$I_C = 8\text{ mA}$; $V_{CE} = 6\text{ V}$; $R_L = 37.5\ \Omega$; $T_{amb} = 25\text{ }^\circ\text{C}$

$V_o = 100\text{ mV}$ at $f_p = 183\text{ MHz}$

$V_o = 100\text{ mV}$ at $f_q = 200\text{ MHz}$

measured at $f(2q-p) = 217\text{ MHz}$

d_{im} typ. -40 dB

Test circuit:

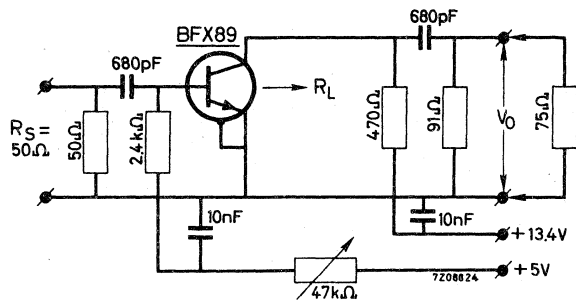

1) Shield lead grounded.

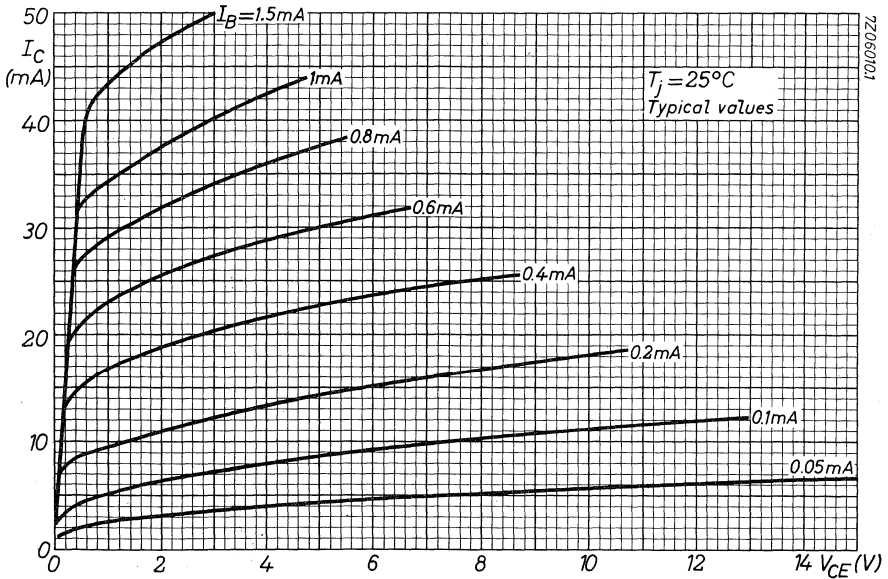
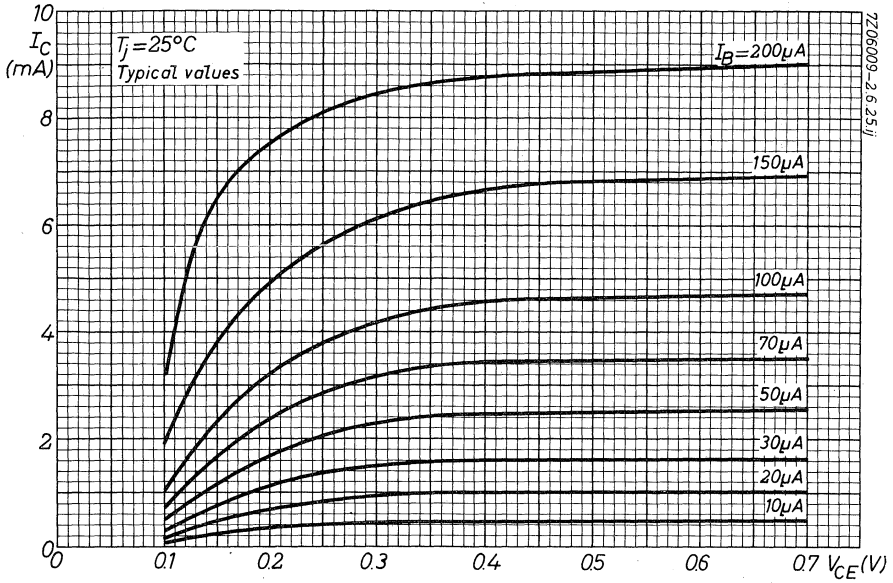

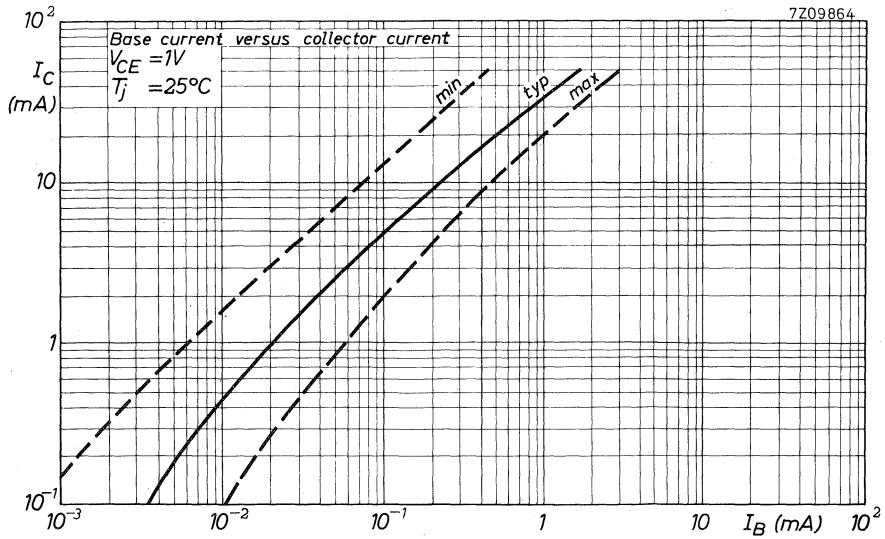
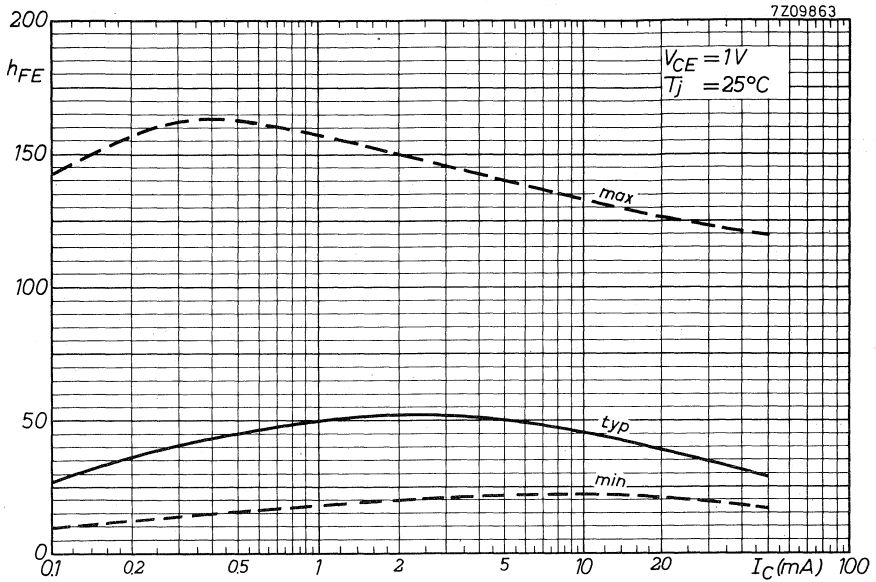

7Z08813

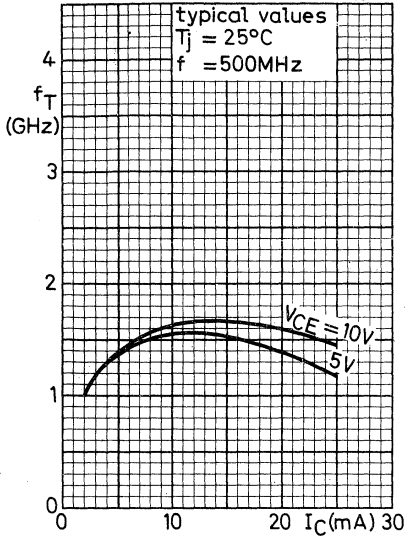

7Z08812

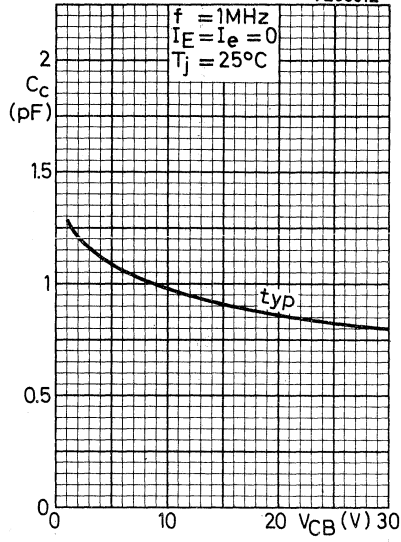

7Z08857

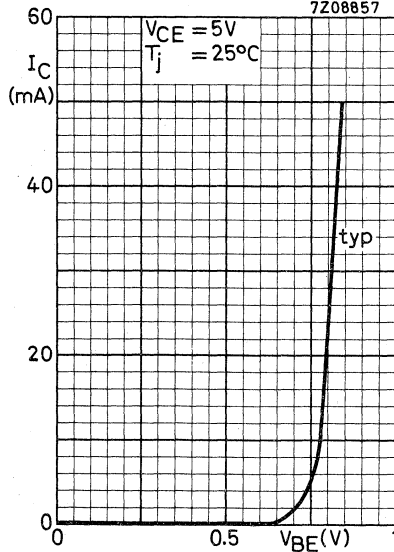

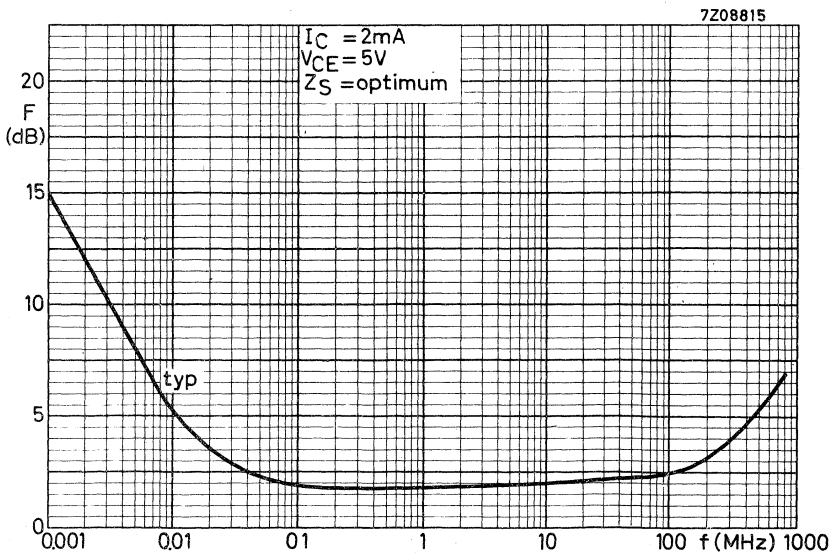
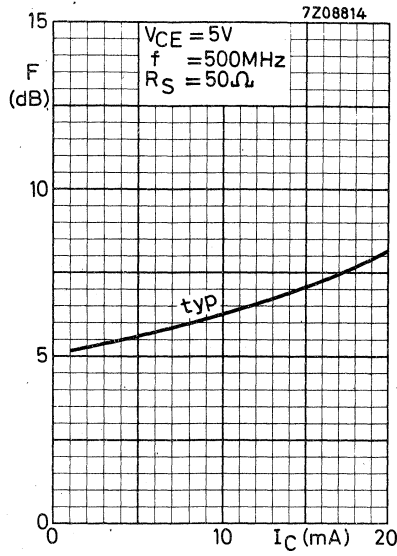

SILICON EPITAXIAL PLANAR TRANSISTORS

N-P-N transistors in a TO-39 metal envelope with the collector connected to the case. These transistors are intended for general purpose industrial applications.

| QUICK REFERENCE DATA | | | | | | |
|--|-------------|------|-------|-------|-------|--------------------|
| | | | BFY50 | BFY51 | BFY52 | |
| Collector-base voltage (open emitter) | V_{CBO} | max. | 80 | 60 | 40 | V |
| Collector-emitter voltage (open base) | V_{CEO} | max. | 35 | 30 | 20 | V |
| Collector current (peak value) | I_{CM} | max. | 1 | 1 | 1 | A |
| Total dissipation up to $T_{mb} = 50\text{ }^{\circ}\text{C}$ | P_{tot} | max. | 5 | 5 | 5 | W |
| Junction temperature | T_j | max. | 200 | 200 | 200 | $^{\circ}\text{C}$ |
| D.C. current gain at $T_j = 25\text{ }^{\circ}\text{C}$ | | | | | | |
| $I_C = 150\text{ mA}; V_{CE} = 10\text{ V}$ | h_{FE} | typ. | 112 | 123 | 142 | |
| Transition frequency | | | | | | |
| $I_C = 50\text{ mA}; V_{CE} = 10\text{ V}$ | f_T | typ. | 140 | 160 | 185 | MHz |
| Saturation voltage | | | | | | |
| $I_C = 500\text{ mA}; I_B = 50\text{ mA}$ | V_{CEsat} | < | 0.7 | 1.0 | 1.0 | V |

MECHANICAL DATA

TO-39
Collector
connected
to case

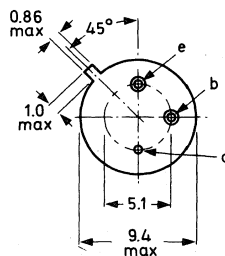

Dimensions in mm

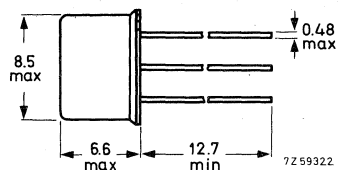

max. lead diameter is guaranteed only for 12.7 mm.
Accessories supplied on request: 56218, 56245.

RATINGS Limiting values in accordance with the Absolute Maximum System (IEC 134)

| <u>Voltages</u> | | | | BFY50 | BFY51 | BFY52 | |
|--|-----------|------|----|-------|-------|-------|--|
| Collector-base voltage (open emitter) | V_{CBO} | max. | 80 | 60 | 40 | V | |
| Collector-emitter voltage (open base) | V_{CEO} | max. | 35 | 30 | 20 | V | |
| Emitter-base voltage (open collector) | V_{EBO} | max. | 6 | 6 | 6 | V | |

Currents

| | | | | | |
|-----------------------------------|-----------|------|--|-----|---|
| Collector current (d. c.) | I_C | max. | | 1 | A |
| Collector current (peak value) | I_{CM} | max. | | 1 | A |
| Emitter current (d. c.) | $-I_E$ | max. | | 1 | A |
| Emitter current (peak value) | $-I_{EM}$ | max. | | 1 | A |
| Reverse base current (peak value) | $-I_{BM}$ | max. | | 0.1 | A |

Power dissipation (See also page 8)

| | | | | | |
|--|-----------|------|--|---|---|
| Total power dissipation up to $T_{mb} = 50\text{ }^{\circ}\text{C}$ | P_{tot} | max. | | 5 | W |
|--|-----------|------|--|---|---|

Temperatures

| | | | | | |
|----------------------|-----------|------|--|-------------|--------------------|
| Storage temperature | T_{stg} | | | -65 to +200 | $^{\circ}\text{C}$ |
| Junction temperature | T_j | max. | | 200 | $^{\circ}\text{C}$ |

THERMAL RESISTANCE

| | | | | | |
|---|----------------|---|--|-----|-----------------------------|
| From junction to ambient in free air | $R_{th\ j-a}$ | = | | 220 | $^{\circ}\text{C}/\text{W}$ |
| From junction to case | $R_{th\ j-c}$ | = | | 35 | $^{\circ}\text{C}/\text{W}$ |
| From junction to mounting base | $R_{th\ j-mb}$ | = | | 30 | $^{\circ}\text{C}/\text{W}$ |

CHARACTERISTICS

$T_j = 25\text{ }^\circ\text{C}$ unless otherwise specified

| <u>Collector cut-off current</u> | | BFY50 | BFY51 | BFY52 | | |
|--|-------------|-------|-------|-------|-------------------|---------------|
| $I_E = 0; V_{CB} = 60\text{ V}$ | I_{CBO} | typ. | 2 | | nA | |
| | | < | 50 | | nA | |
| $I_E = 0; V_{CB} = 40\text{ V}$ | I_{CBO} | typ. | | 2 | nA | |
| | | < | | 50 | nA | |
| $I_E = 0; V_{CB} = 30\text{ V}$ | I_{CBO} | typ. | | | 2 nA | |
| | | < | | | 50 nA | |
| $I_E = 0; V_{CB} = 60\text{ V}; T_j = 100\text{ }^\circ\text{C}$ | I_{CBO} | typ. | 100 | | nA | |
| | | < | 2.5 | | μA | |
| $I_E = 0; V_{CB} = 40\text{ V}; T_j = 100\text{ }^\circ\text{C}$ | I_{CBO} | typ. | | 100 | nA | |
| | | < | | 2.5 | μA | |
| $I_E = 0; V_{CB} = 30\text{ V}; T_j = 100\text{ }^\circ\text{C}$ | I_{CBO} | typ. | | | 100 nA | |
| | | < | | | 2.5 μA | |
| <u>Emitter cut-off current</u> | | | | | | |
| $I_C = 0; V_{EB} = 5\text{ V}$ | I_{EBO} | typ. | 2 | 2 | 2 | nA |
| | | < | 50 | 50 | 50 | nA |
| $I_C = 0; V_{EB} = 5\text{ V}; T_j = 100\text{ }^\circ\text{C}$ | I_{EBO} | typ. | 0.1 | 0.1 | 0.1 | μA |
| | | < | 2.5 | 2.5 | 2.5 | μA |
| <u>Saturation voltages</u> | | | | | | |
| $I_C = 10\text{ mA}; I_B = 1.0\text{ mA}$ | V_{CEsat} | typ. | 0.06 | 0.06 | 0.06 | V |
| | | < | 0.10 | 0.15 | 0.15 | V |
| | V_{BEsat} | typ. | 0.69 | 0.69 | 0.69 | V |
| | | < | 1.2 | 1.2 | 1.2 | V |
| $I_C = 150\text{ mA}; I_B = 15\text{ mA}$ | V_{CEsat} | typ. | 0.15 | 0.15 | 0.15 | V |
| | | < | 0.20 | 0.35 | 0.35 | V |
| | V_{BEsat} | typ. | 0.92 | 0.92 | 0.92 | V |
| | | < | 1.3 | 1.3 | 1.3 | V |
| $I_C = 500\text{ mA}; I_B = 50\text{ mA}$ ¹⁾ | V_{CEsat} | typ. | 0.35 | 0.35 | 0.35 | V |
| | | < | 0.70 | 1.00 | 1.00 | V |
| | V_{BEsat} | typ. | 1.15 | 1.15 | 1.15 | V |
| | | < | 1.5 | 1.5 | 1.5 | V |
| $I_C = 1\text{ A}; I_B = 100\text{ mA}$ ¹⁾ | V_{CEsat} | typ. | 0.66 | 0.66 | 0.66 | V |
| | | < | 1.00 | 1.60 | 1.60 | V |
| | V_{BEsat} | typ. | 1.40 | 1.40 | 1.40 | V |
| | | < | 2.0 | 2.0 | 2.0 | V |

¹⁾ Measured under pulsed conditions to avoid excessive dissipation.

CHARACTERISTICS (continued)

$T_j = 25\text{ }^\circ\text{C}$ unless otherwise specified

D.C. current gain

$I_C = 10\text{ mA}; V_{CE} = 10\text{ V}$

| | BFY50 | BFY51 | BFY52 |
|----------|-------|-------|-------|
| h_{FE} | > 20 | 30 | 30 |
| typ. | 80 | 85 | 90 |

$I_C = 150\text{ mA}; V_{CE} = 10\text{ V}^1)$

| | | | |
|----------|------|-----|-----|
| h_{FE} | > 30 | 40 | 60 |
| typ. | 112 | 123 | 142 |

$I_C = 500\text{ mA}; V_{CE} = 10\text{ V}^1)$

| | | | |
|----------|------|----|----|
| h_{FE} | > 20 | 25 | 30 |
| typ. | 70 | 79 | 90 |

$I_C = 1\text{ A}; V_{CE} = 10\text{ V}^1)$

| | | | |
|----------|------|----|----|
| h_{FE} | > 15 | 15 | 15 |
| typ. | 35 | 40 | 50 |

Switching times (See also page 5)

$I_C = 150\text{ mA}; +I_B = -I_{BM} = 15\text{ mA}$

delay time

| | | | | |
|-------|---------|----|----|----|
| t_d | typ. 15 | 15 | 15 | ns |
|-------|---------|----|----|----|

rise time

| | | | | |
|-------|---------|----|----|----|
| t_r | typ. 40 | 40 | 40 | ns |
|-------|---------|----|----|----|

storage time

| | | | | |
|-------|----------|-----|-----|----|
| t_s | typ. 300 | 300 | 300 | ns |
|-------|----------|-----|-----|----|

fall time

| | | | | |
|-------|---------|----|----|----|
| t_f | typ. 60 | 60 | 60 | ns |
|-------|---------|----|----|----|

Collector capacitance at $f = 1\text{ MHz}$

$I_E = I_e = 0; V_{CB} = 10\text{ V}$

| | | | | |
|-------|------|----|----|----|
| C_c | < 12 | 12 | 12 | pF |
|-------|------|----|----|----|

Transition frequency at $f = 35\text{ MHz}$

$I_C = 50\text{ mA}; V_{CE} = 10\text{ V}$

| | | | | |
|-------|------|-----|-----|-----|
| f_T | > 60 | 50 | 50 | MHz |
| typ. | 140 | 160 | 185 | MHz |

h parameters at $f = 1\text{ kHz}$

$I_C = 10\text{ mA}; V_{CE} = 5\text{ V}$

Input impedance

| | | | | |
|----------|-------|-----|-----|----------|
| h_{ie} | < 750 | 750 | 750 | Ω |
|----------|-------|-----|-----|----------|

Reverse voltage transfer ratio

| | | | | |
|----------|-------|-----|-----|-----------|
| h_{re} | < 5.0 | 5.0 | 5.0 | 10^{-4} |
|----------|-------|-----|-----|-----------|

Small signal current gain

| | | | |
|----------|------|-----|-----|
| h_{fe} | > 15 | 45 | 45 |
| typ. | 90 | 100 | 110 |

Output admittance

| | | | | |
|----------|------|----|----|------------------|
| h_{oe} | < 80 | 80 | 80 | $\mu\Omega^{-1}$ |
|----------|------|----|----|------------------|

$I_C = 1\text{ mA}; V_{CE} = 5\text{ V}$

Small signal current gain

| | | | |
|----------|------|----|----|
| h_{fe} | > 10 | 30 | 30 |
| typ. | 60 | 65 | 70 |

¹⁾ Measured under pulsed conditions to avoid excessive dissipation.

MEASUREMENT OF SWITCHING TIMES

Fig.1 : Circuit diagram

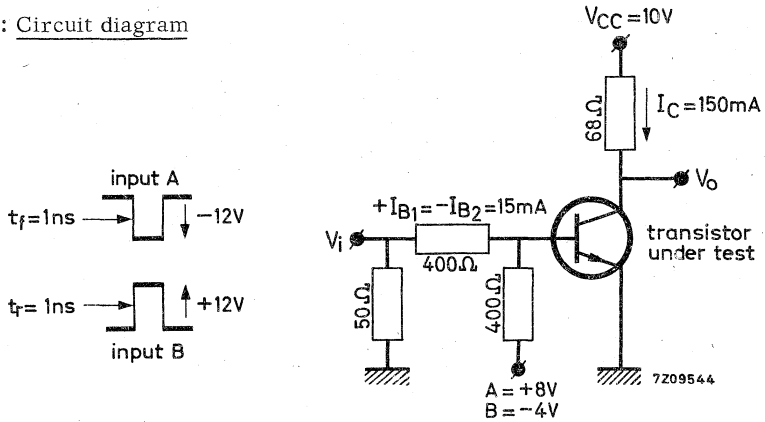
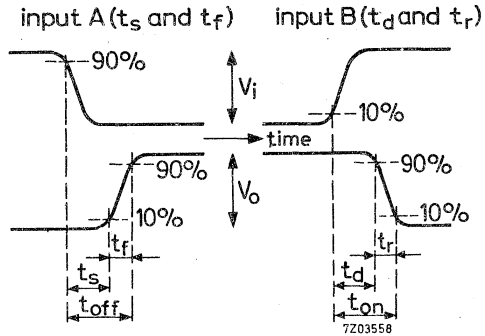

Fig.2 : Waveforms



Equipment Pulse generator: rise time $t_r = 1 \text{ ns}$
 pulse duration $t_p = 1 \mu\text{s}$
 Double beam or dual trace oscilloscope: rise time $t_r < 5 \text{ ns}$

OPERATING NOTES (Dissipation and heatsink considerations)

1. Steady-state conditions

The max. allowable steady-state dissipation P_s is given by the relationship

$$P_{s \text{ max.}} = \frac{T_{j \text{ max.}} - T_{\text{amb}}}{R_{\text{th j-a}}}$$

where $T_{j \text{ max.}}$ is the maximum permissible operating junction temperature,
 T_{amb} is the ambient temperature,

$R_{\text{th j-a}}$ is the total thermal resistance between junction and ambient.

2. Pulse conditions (rectangular pulses)

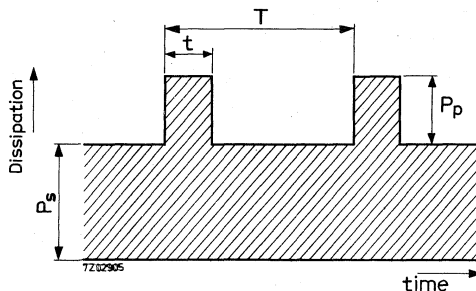

The maximum allowable pulse power P_p is given by the formula

$$P_p = \frac{(T_{j \text{ max.}} - T_{\text{amb}}) - (P_s \cdot R_{\text{th j-a}})}{Z_{\text{th}} + \delta \cdot R_{\text{th mb-a}}}$$

where Z_{th} is the thermal impedance of the device between junction and mounting base and is a function of the pulse duration t and duty cycle δ (see page 9),

δ is the duty cycle and is equal to the pulse duration t divided by the periodic time T ,

$R_{\text{th mb-a}}$ is the total thermal resistance between mounting base and ambient.

Example

The following example shows how to calculate the maximum permissible peak dissipation of a BFY50 mounted in free air at a temperature not exceeding 65 °C. The steady-state dissipation under the bottomed condition is 350 mW, the pulse width is 1 ms and the duty cycle is 0.2.

The thermal impedance $Z_{\text{th}} = 13 \text{ }^\circ\text{C/W}$ (from page 9)

OPERATING NOTES (continued)

$$P_{pmax} = \frac{(200-65) - (0.35 \times 220)}{13 + 0.2 (220-30)}$$

$$= \frac{135 - 77}{13 + 38} = 1.14 \text{ W}$$

The peak pulse dissipation of 1.14 W is therefore allowed provided that the voltage and current ratings of the device are not exceeded.

3. Pulse conditions (other than rectangular)

For sinusoidal and irregular shaped waveforms, the power pulse is converted to an equivalent rectangular pulse of the same average and peak values, and treated as in the previous section.

Example

The following example illustrates how to find the maximum permissible peak dissipation of a BFY52 operating in a class "B" circuit at 1 kHz. The device is mounted on a heatsink of thermal resistance equal to 50 °C/W and at an ambient temperature not exceeding 100 °C. Assuming that the waveform is sinusoidal for half period and zero for the other half,

$$\text{Average of sinewave over half cycle} = \frac{2 P_p}{\pi}$$

Therefore equivalent rectangular pulse width of same amplitude and average value,

$$t = \frac{2}{\omega} = \frac{2}{2 \pi \times 10^3} = 0.318 \text{ ms}$$

$$\text{Duty cycle } \delta = \frac{2/\omega}{2\pi/\omega} = \frac{1}{\pi}$$

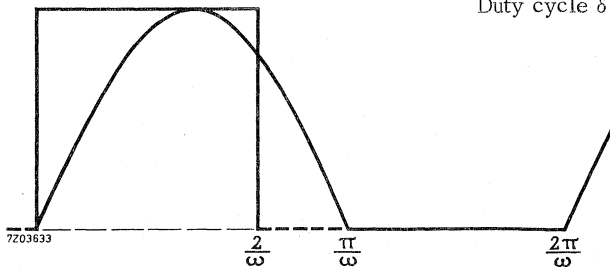

From page 9: $Z_{th 0} = 6.0 \text{ °C/W}$ $R_{th j-mb} = 30 \text{ °C/W}$

$$Z_{th} (\text{at } \delta = 0.318) = 6.0 + 0.318 (30-6.0) = 13.6 \text{ °C/W}$$

$$P_{pmax} = \frac{(200-100) - 0}{13.6 + 0.318 \times 50} = 3.39 \text{ W}$$

A peak power of 3.39 W is therefore permissible provided that the voltage and current ratings of the device are not exceeded.

BFY50 to 52

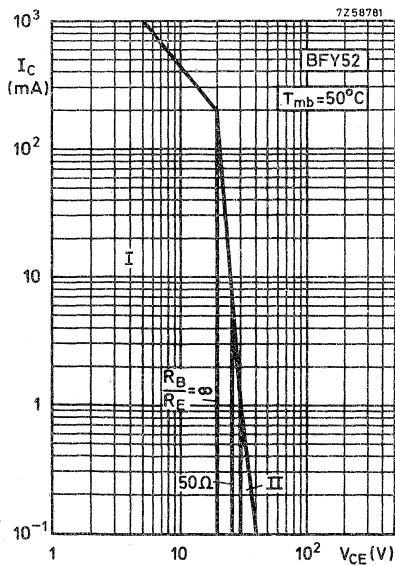
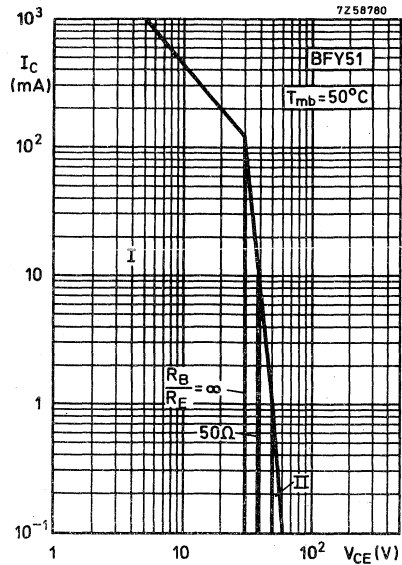
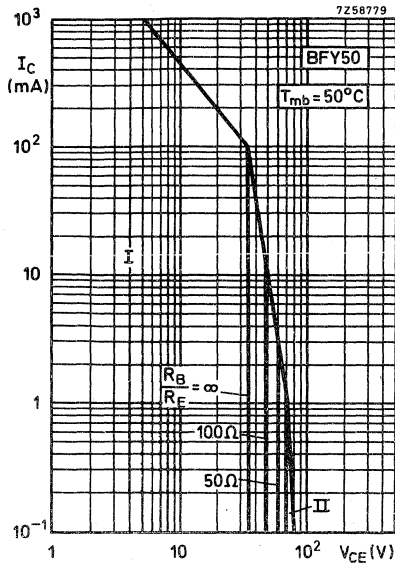

Safe Operating Area with the transistor forward biased

- I. Region of permissible d.c. operation
- II. Additional area for d.c. operation when $R_B / R_E < 10\ \Omega$

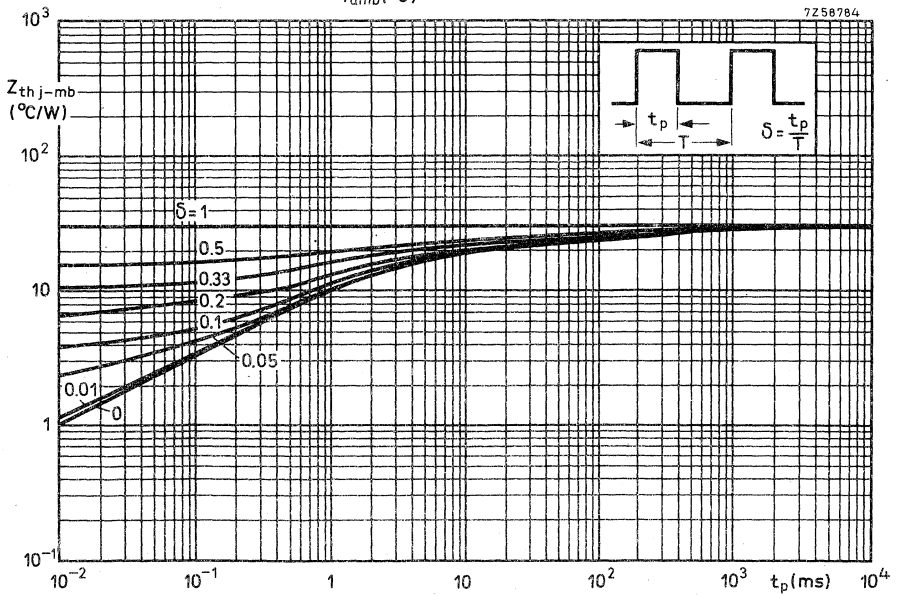
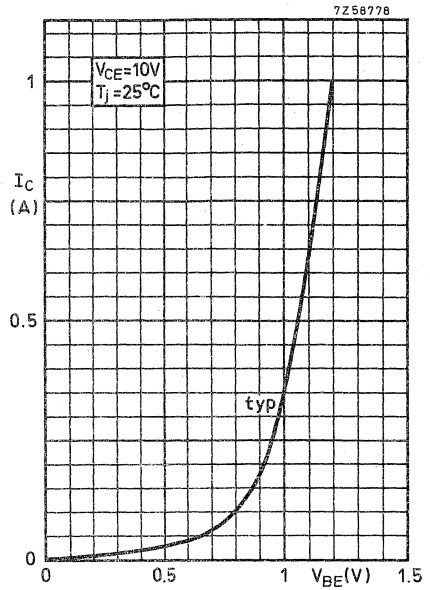
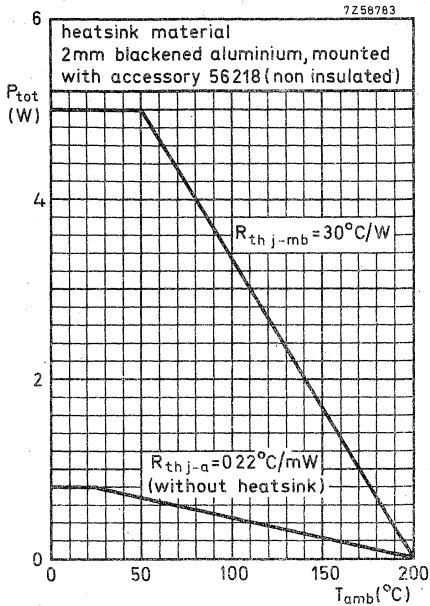

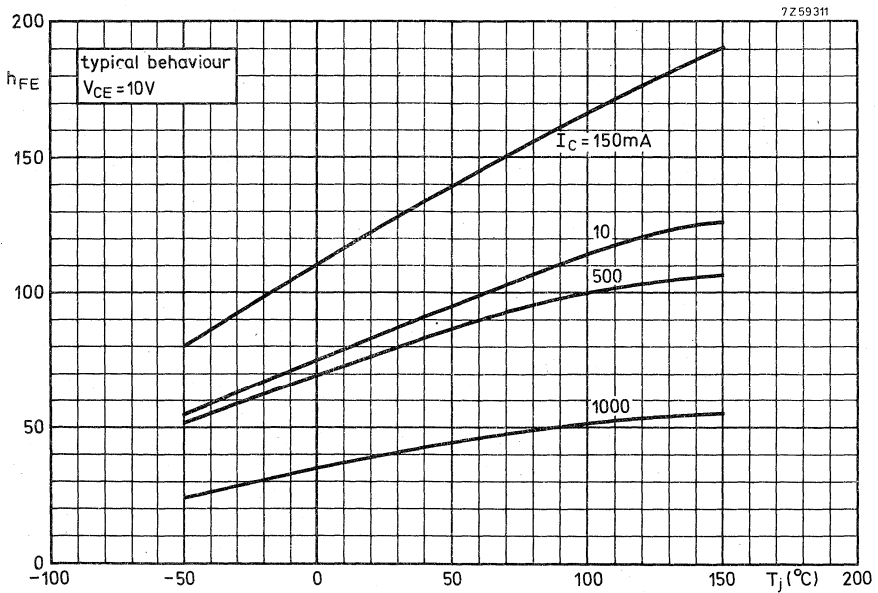
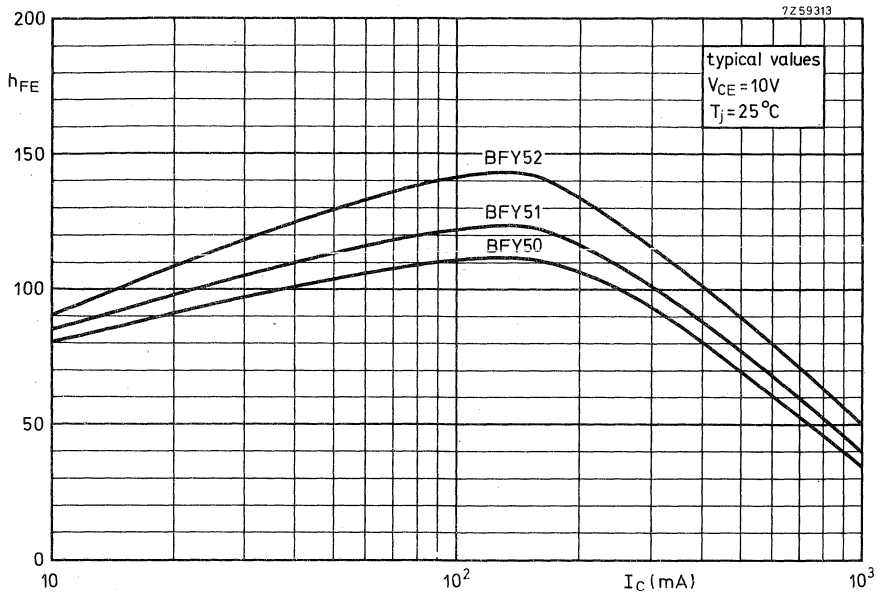

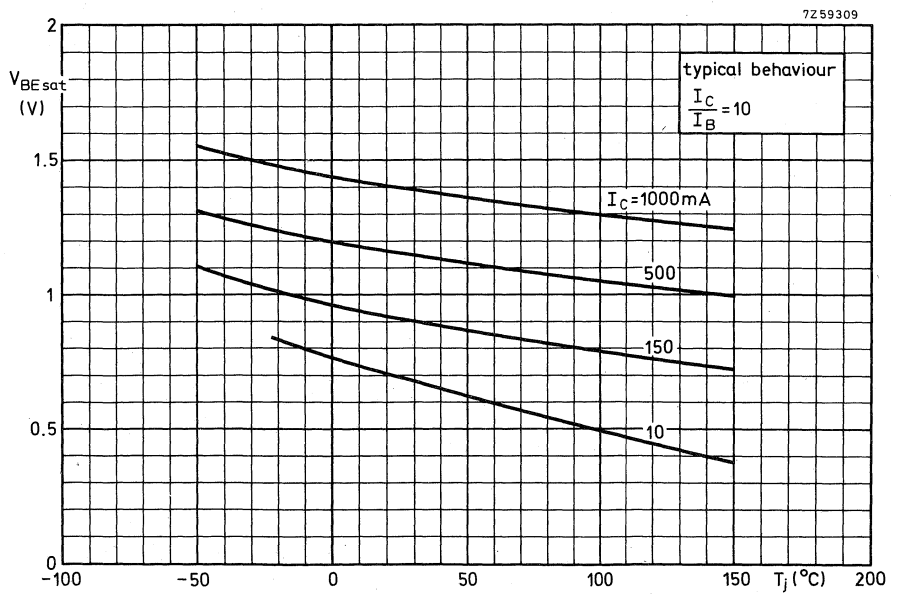
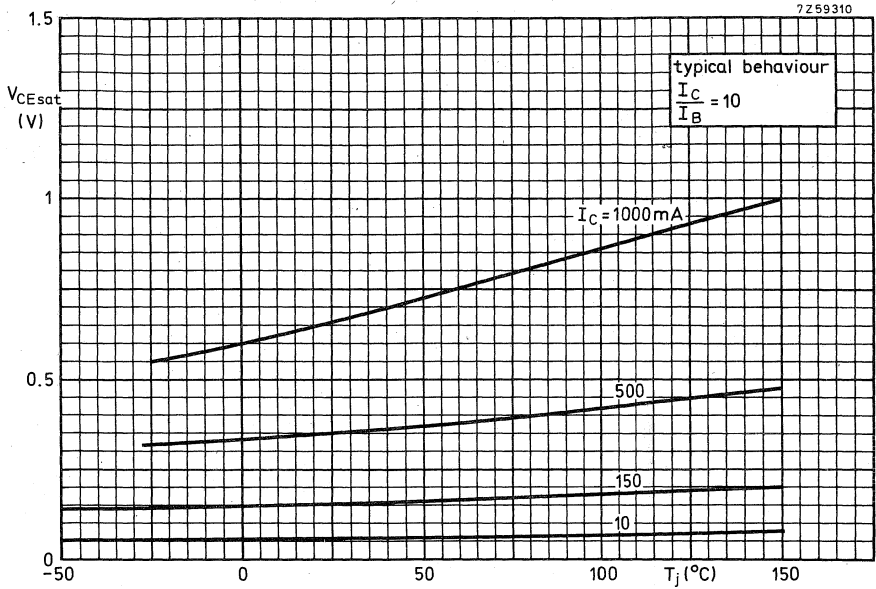

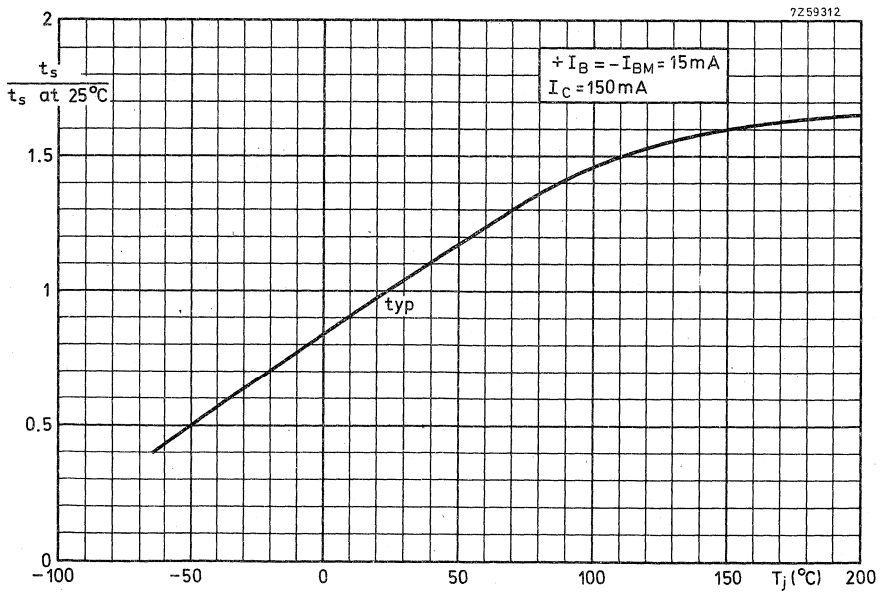
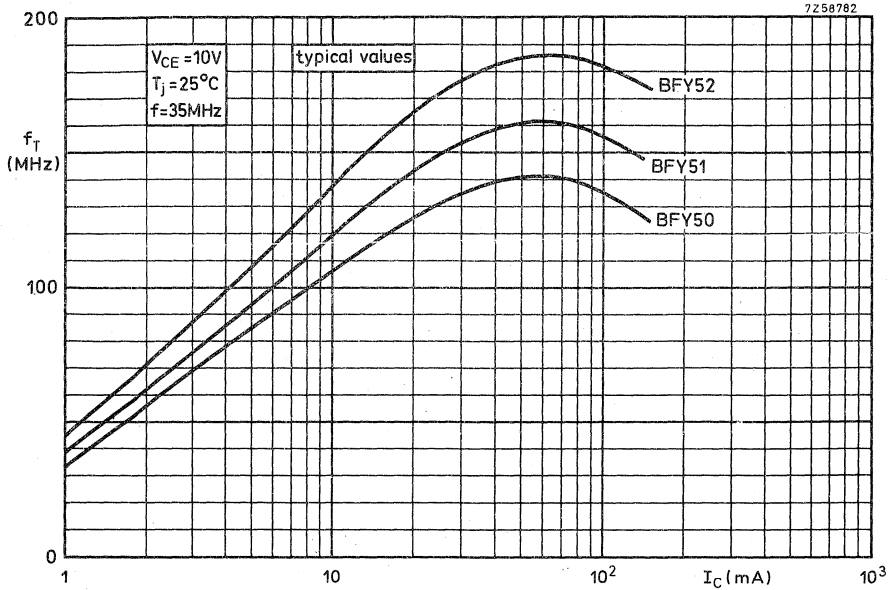

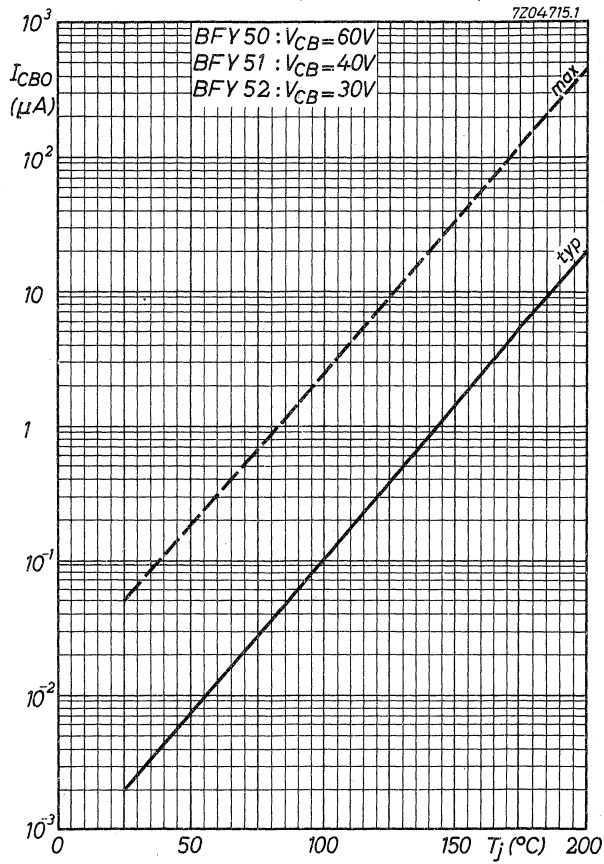

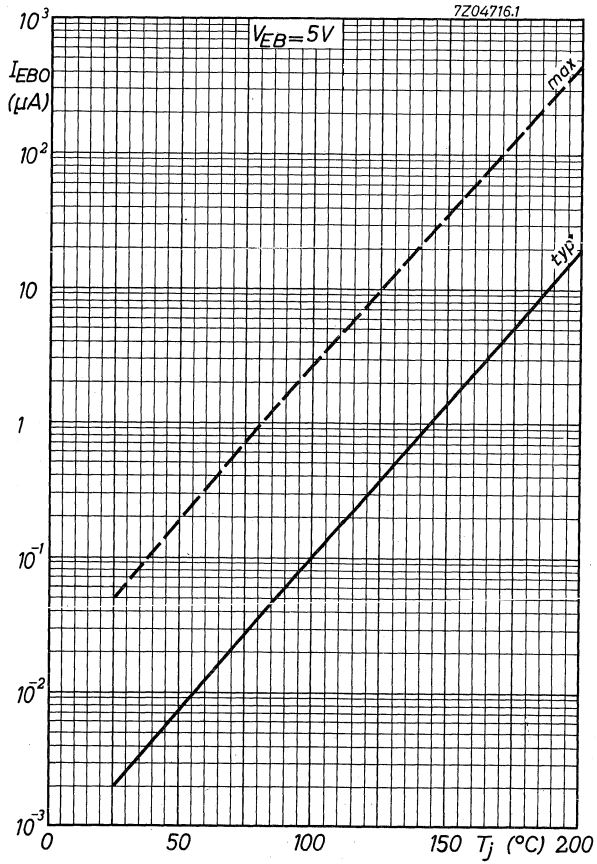

SILICON PLANAR EPITAXIAL TRANSISTOR

N-P-N transistor in TO-39 metal case with the collector connected to the case. It is primarily intended for use in high frequency and very high frequency oscillators and amplifiers as well as for output stages of servo amplifiers.

| QUICK REFERENCE DATA | | |
|--|-------------|---------------------------|
| Collector-base voltage (open emitter) | V_{CBO} | max. 80 V |
| Collector-emitter voltage (open base) | V_{CEO} | max. 35 V |
| Collector current (d. c.) | I_C | max. 1 A |
| Total power dissipation up to $T_{amb} = 25\text{ }^\circ\text{C}$ | P_{tot} | max. 800 mW |
| Junction temperature | T_j | max. 200 $^\circ\text{C}$ |
| D. C. current gain at $T_j = 25\text{ }^\circ\text{C}$ | | |
| $I_C = 150\text{ mA}; V_{CE} = 10\text{ V}$ | h_{FE} | > 40 |
| Transition frequency | | |
| $I_C = 50\text{ mA}; V_{CE} = 10\text{ V}$ | f_T | > 60 MHz |
| Collector-emitter saturation voltage | | |
| $I_C = 1\text{ A}; I_B = 100\text{ mA}$ | V_{CEsat} | < 1 V |

MECHANICAL DATA

Dimensions in mm

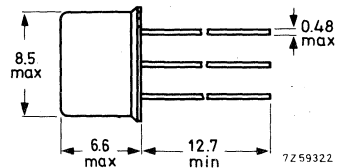
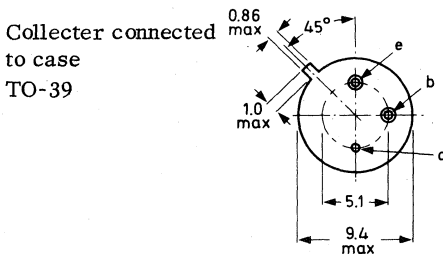

max. lead diameter is guaranteed only for 12.7 mm

Accessories available: 56218, 56245.

RATINGS (Limiting values) ¹⁾

Voltages

| | | | |
|---------------------------------------|-----------|------|------|
| Collector-base voltage (open emitter) | V_{CBO} | max. | 80 V |
| Collector-emitter voltage (open base) | V_{CEO} | max. | 35 V |
| Emitter-base voltage (open collector) | V_{EBO} | max. | 7 V |

Currents

| | | | |
|--------------------------------|-----------|------|-----|
| Collector current (d.c.) | I_C | max. | 1 A |
| Collector current (peak value) | I_{CM} | max. | 1 A |
| Emitter current (d.c.) | $-I_E$ | max. | 1 A |
| Emitter current (peak value) | $-I_{EM}$ | max. | 1 A |

Power dissipation (See also page 4)

| | | | |
|---|-----------|------|-------|
| Total power dissipation up to $T_{amb} = 40\text{ }^{\circ}\text{C}$ | P_{tot} | max. | 4 W |
| Total power dissipation without cooling fin up to $T_{amb} = 25\text{ }^{\circ}\text{C}$ | P_{tot} | max. | 0.8 W |

Temperatures

| | | | |
|----------------------|-----------|-------------|------------------------|
| Storage temperature | T_{stg} | -65 to +200 | $^{\circ}\text{C}$ |
| Junction temperature | T_j | max. | 200 $^{\circ}\text{C}$ |

THERMAL RESISTANCE

| | | | |
|--------------------------------------|---------------|---|------------------------------------|
| From junction to ambient in free air | $R_{th\ j-a}$ | = | 0.22 $^{\circ}\text{C}/\text{mW}$ |
| From junction to case | $R_{th\ j-c}$ | = | 0.035 $^{\circ}\text{C}/\text{mW}$ |

¹⁾ Limiting values according to the Absolute Maximum System as defined in IEC publication 134.

CHARACTERISTICS

$T_j = 25\text{ }^\circ\text{C}$ unless otherwise specified

Collector cut-off current

| | | | |
|--|-----------|---|------------------|
| $I_E = 0; V_{CB} = 60\text{ V}$ | I_{CBO} | < | 10 nA |
| $I_E = 0; V_{CB} = 60\text{ V}; T_j = 150\text{ }^\circ\text{C}$ | I_{CBO} | < | 10 μA |

Emitter cut-off current

| | | | |
|--------------------------------|-----------|---|-------|
| $I_C = 0; V_{EB} = 5\text{ V}$ | I_{EBO} | < | 10 nA |
|--------------------------------|-----------|---|-------|

Saturation voltages

| | | | |
|---|-------------|---|-------|
| $I_C = 150\text{ mA}; I_B = 15\text{ mA}$ | V_{CEsat} | < | 0.2 V |
| $I_C = 1\text{ A}; I_B = 100\text{ mA}$ ¹⁾²⁾ | V_{CEsat} | < | 1.0 V |
| | V_{BEsat} | < | 1.6 V |

Sustaining voltage

| | | | |
|---|----------------------|---|------|
| $I_C = 30\text{ mA}; I_B = 0$ ²⁾ | $V_{CEO\text{sust}}$ | > | 35 V |
|---|----------------------|---|------|

D.C. current gain ²⁾

| | | | |
|---|----------|---|-----------|
| $I_C = 10\text{ mA}; V_{CE} = 10\text{ V}$ | h_{FE} | > | 30 |
| $I_C = 150\text{ mA}; V_{CE} = 10\text{ V}$ | h_{FE} | | 40 to 120 |
| $I_C = 1\text{ A}; V_{CE} = 10\text{ V}$ | h_{FE} | > | 15 |

Feedback time constant

| | | | |
|--|-----------------|---|--------|
| $I_C = 10\text{ mA}; V_{CB} = 10\text{ V}; f = 4\text{ MHz}$ | $r_b \cdot C_c$ | < | 800 ps |
|--|-----------------|---|--------|

Collector capacitance at $f = 500\text{ kHz}$

| | | | |
|---------------------------------------|-------|---|-------|
| $I_E = I_e = 0; V_{CB} = 10\text{ V}$ | C_c | < | 12 pF |
|---------------------------------------|-------|---|-------|

Emitter capacitance at $f = 500\text{ kHz}$

| | | | |
|--|-------|---|-------|
| $I_C = I_c = 0; V_{EB} = 0.5\text{ V}$ | C_e | < | 80 pF |
|--|-------|---|-------|

Transition frequency

| | | | |
|--|-------|---|--------|
| $I_C = 50\text{ mA}; V_{CE} = 10\text{ V}$ | f_T | > | 60 MHz |
|--|-------|---|--------|

¹⁾ Measured with a lead length of 1 cm.

²⁾ Measured under pulsed conditions to avoid excessive dissipation.
Pulse duration = 300 μs ; duty cycle $\delta < 0.01$

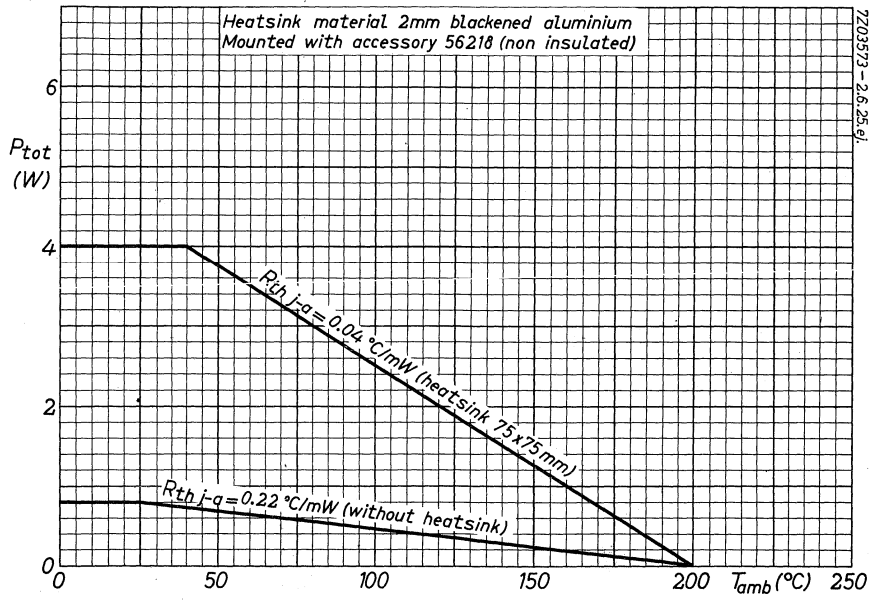

7203588-2,6,25,ee.

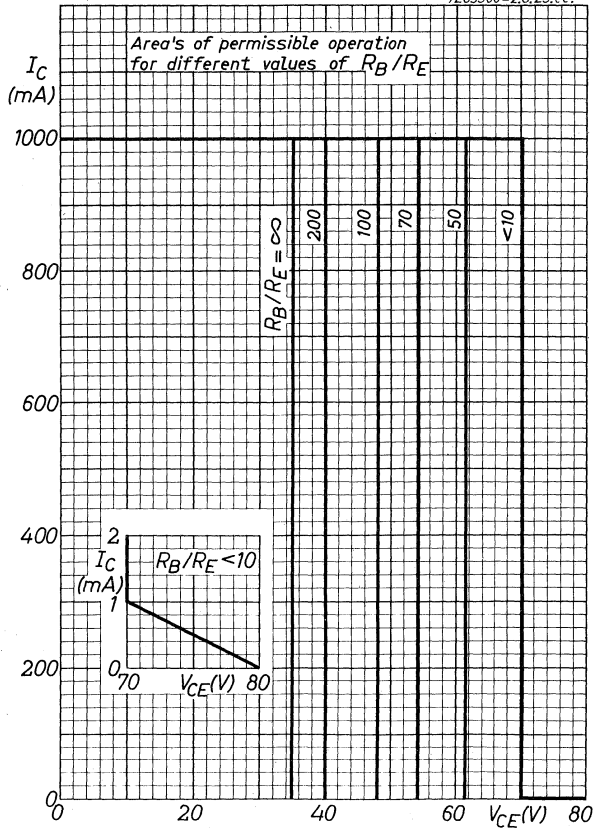

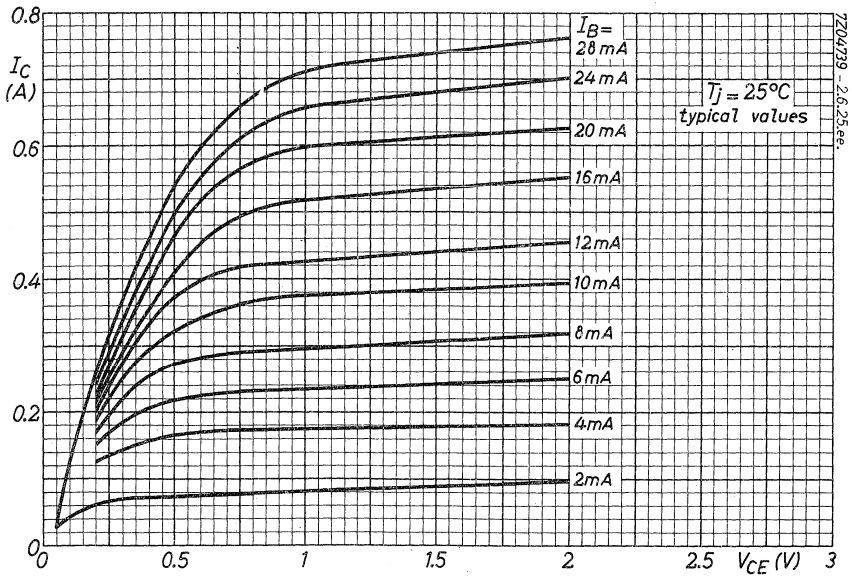
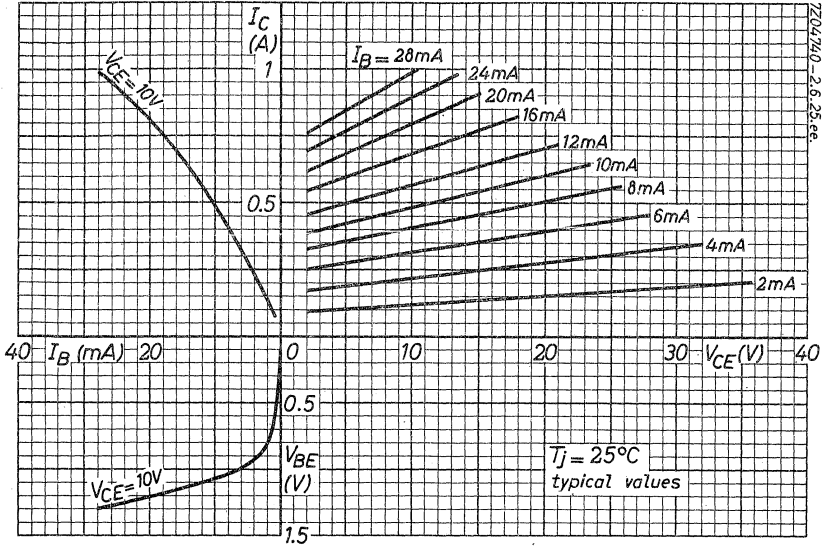

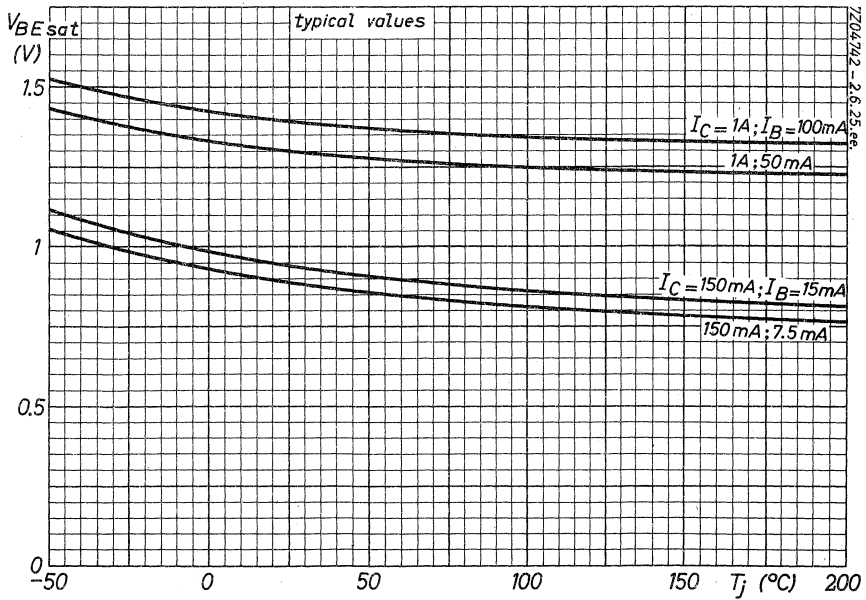
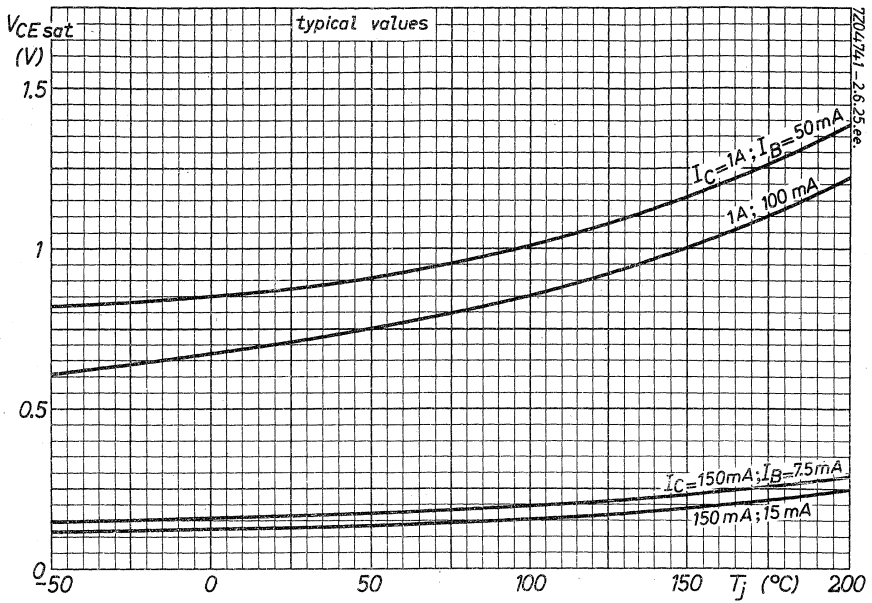

BFY55

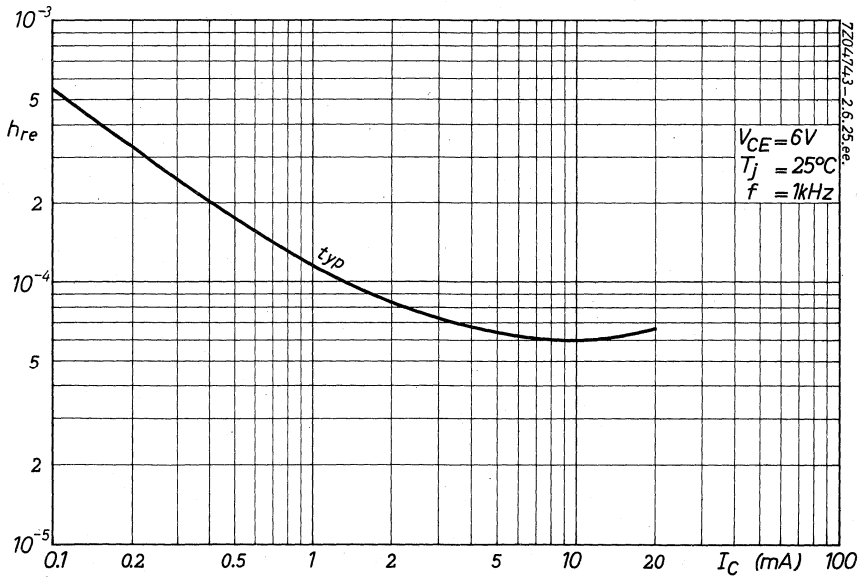
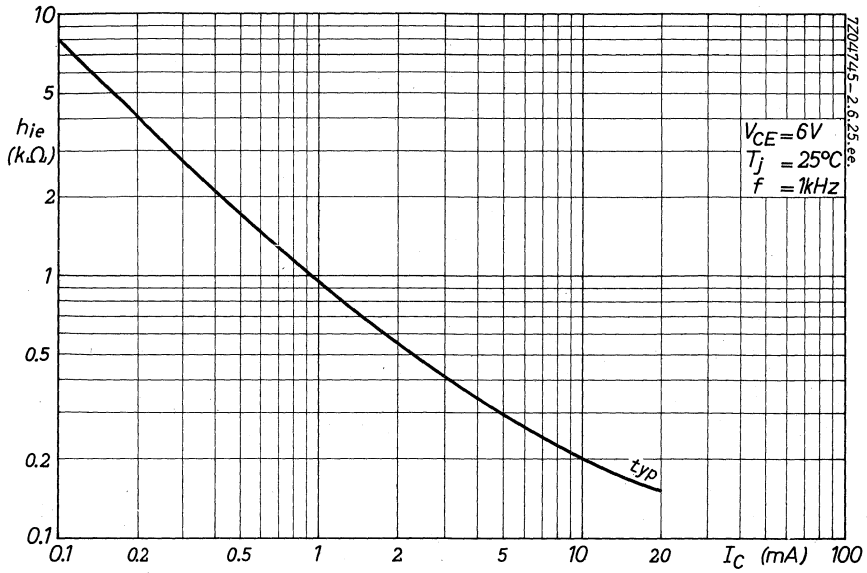

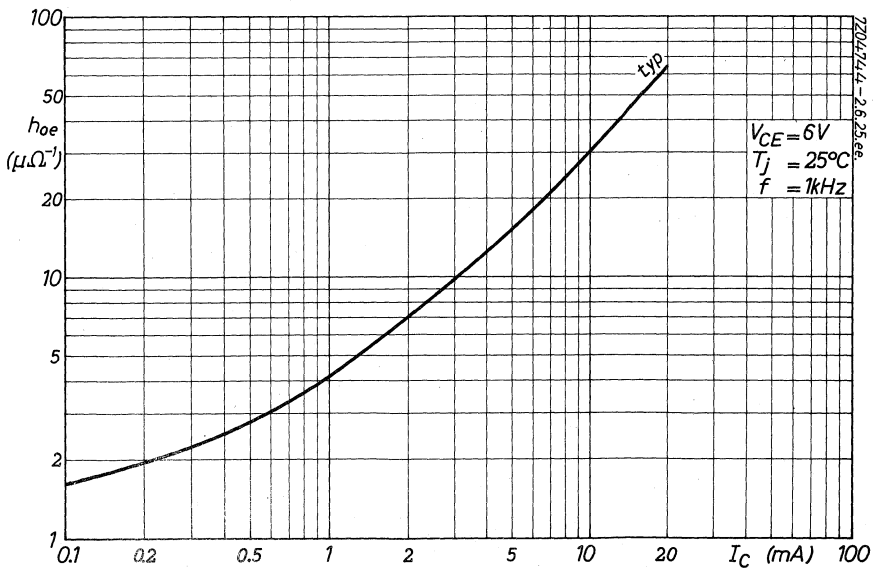
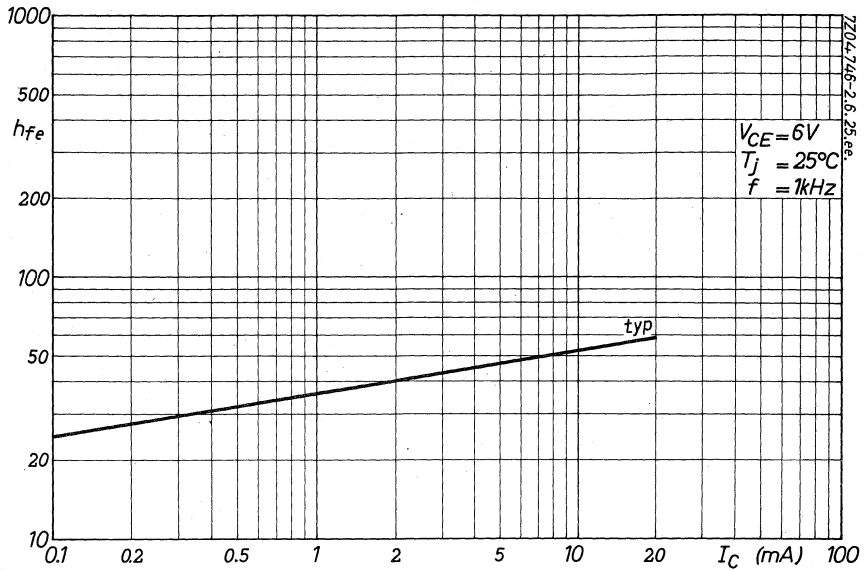

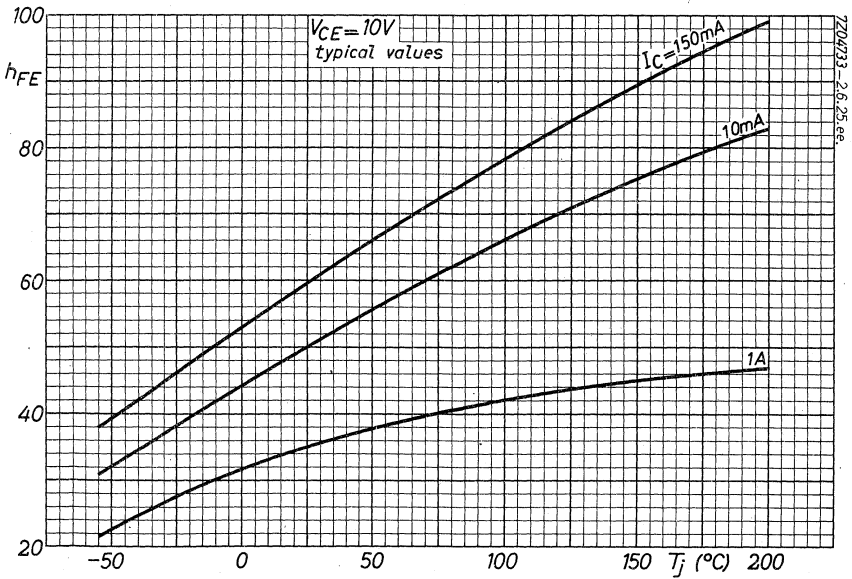
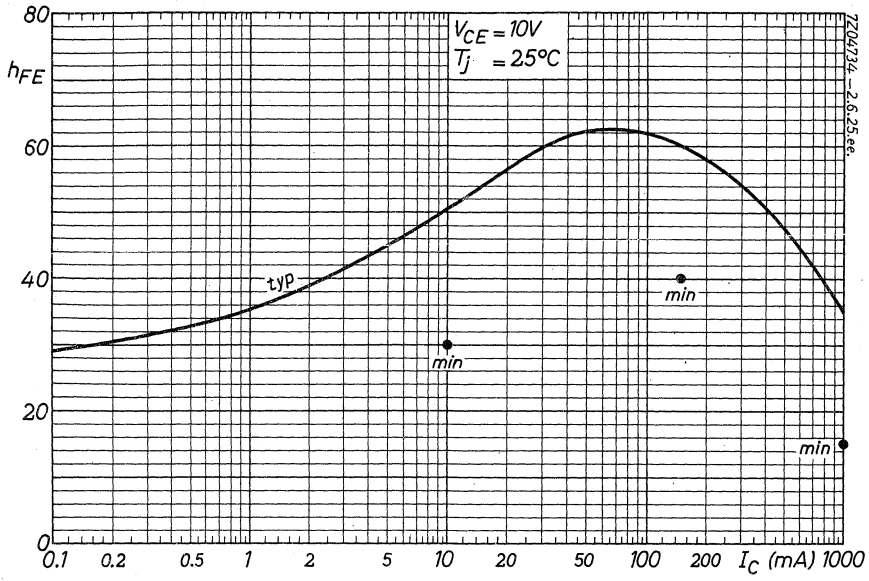

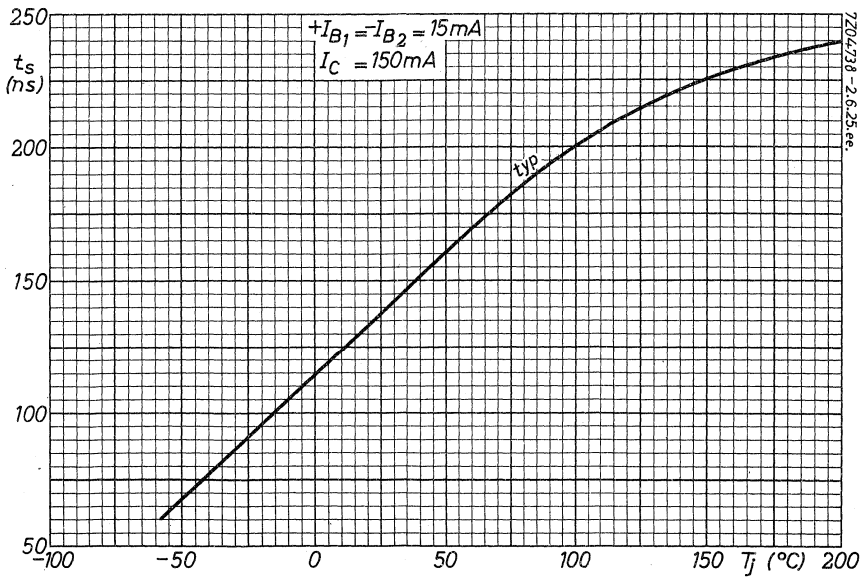
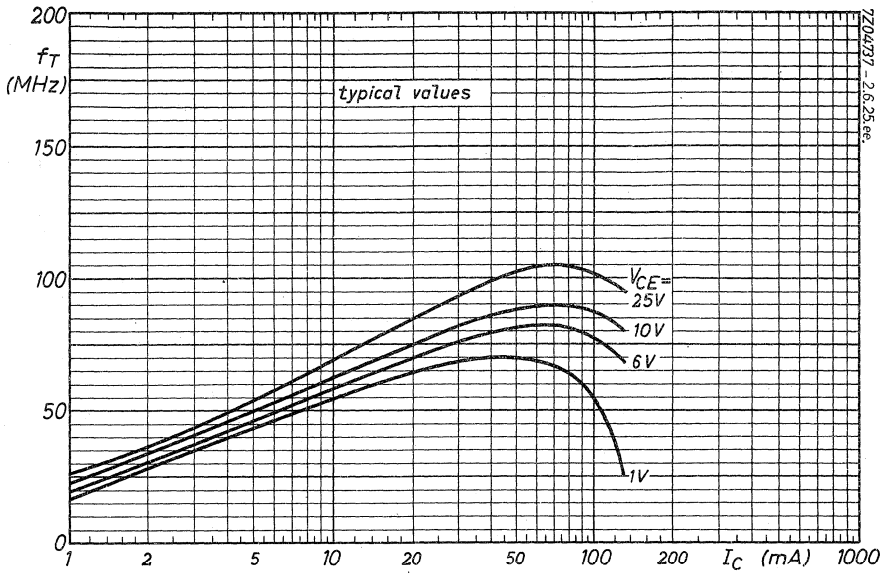

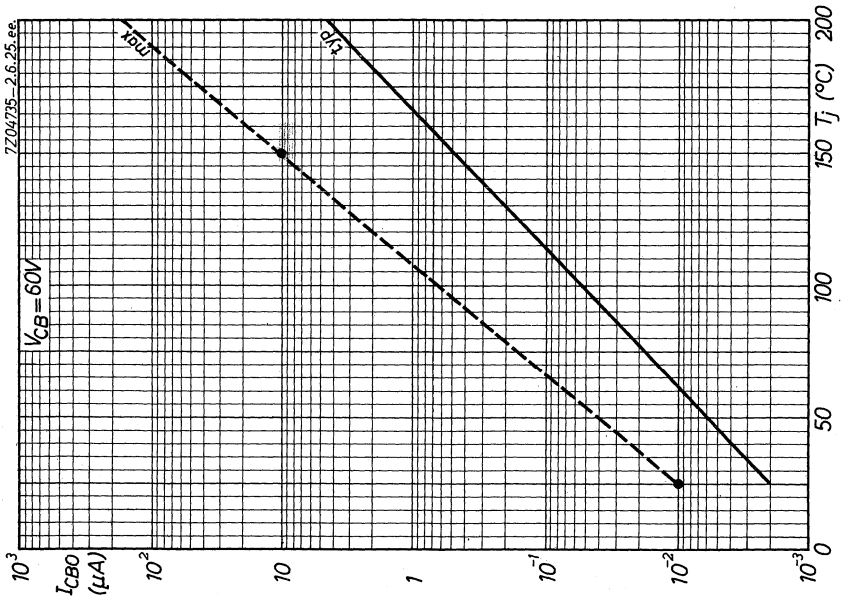
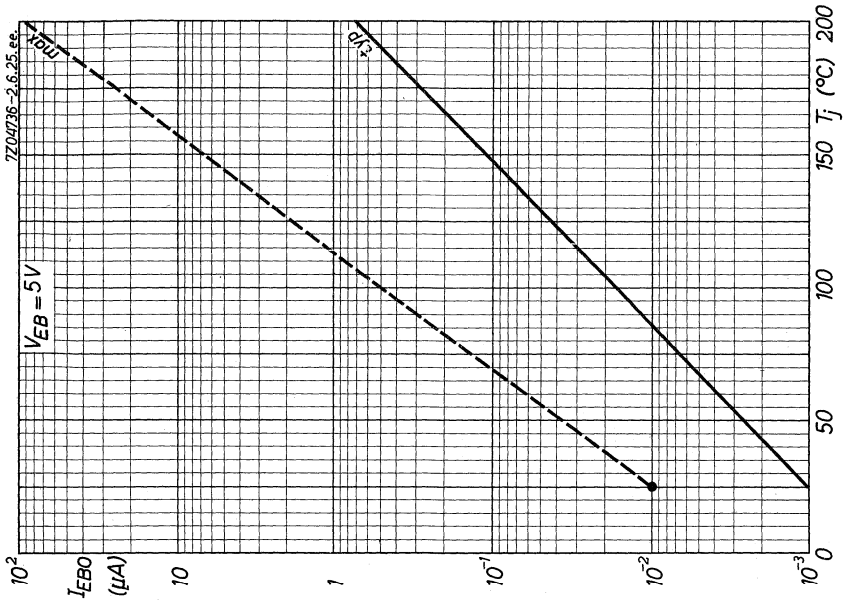

SILICON PLANAR EPITAXIAL TRANSISTOR

N-P-N transistor in a TO-72 metal envelope with insulated electrodes and a shield lead connected to the case.

The transistor has very low noise over a wide current range, a very high power gain and excellent intermodulation properties.

It is primarily intended for:

- Channel- and band aerial amplifiers for band I, II, III and IV/V (40-860 MHz)
- Wide band aerial amplifiers (40-860 MHz)
- Television distribution amplifiers
- Low noise wide band vertical amplifier in high speed oscilloscopes

It is also suitable for military- and industrial applications, such as:

- R.F. amplifiers and mixers for communication equipment
- Microwave telephony link systems, wide band i.f. amplifiers
- Large bandwidth radar i.f. amplifiers

QUICK REFERENCE DATA

| | | | |
|---|------------|---------------------------|-------------------|
| Collector-base voltage (open emitter; peak value) | V_{CBOM} | max. | 30 V |
| Collector-emitter voltage (open base) | V_{CEO} | max. | 15 V |
| Collector current (peak value; $f > 1$ MHz) | I_{CM} | max. | 50 mA |
| Total power dissipation up to $T_{amb} = 25$ °C | P_{tot} | max. | 200 mW |
| Junction temperature | T_j | max. | 200 °C |
| Transition frequency $I_C = 25$ mA; $V_{CE} = 5$ V; $f = 500$ MHz | f_T | typ. | 1.4 GHz |
| Feedback capacitance at $f = 1$ MHz $I_C = 2$ mA; $V_{CE} = 5$ V | C_{re} | typ. | 0.6 pF |
| Noise figure at optimum source impedance $I_C = 2$ mA; $V_{CE} = 5$ V | F | $f = 200$ MHz typ. 2.5 | 800 MHz 5.5 dB |
| Power gain (not neutralized) $I_C = 14$ mA; $V_{CE} = 10$ V | G_p | typ. 23 | 8 dB |
| Output power $d_{im} = -30$ dB; V.S.W.R. at output < 2 $I_C = 14$ mA; $V_{CE} = 10$ V | P_o | typ. 12 | 12 mW |

MECHANICAL DATA see page 2.

MECHANICAL DATA

Dimensions in mm

TO-72

insulated electrodes

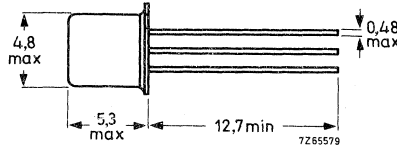
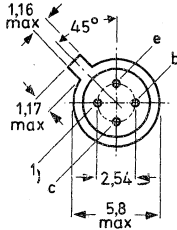

1) = shield lead (connected to case)

Accessories available: 56246; 56263

RATINGS (Limiting values) ¹⁾

Voltages

| | | | |
|--|------------|------|--------------------|
| Collector-base voltage (open emitter; peak value) | V_{CBOM} | max. | 30 V |
| Collector-emitter voltage (peak value) $R_{BE} \leq 50 \Omega$ | V_{CERM} | max. | 30 V ²⁾ |
| Collector-emitter voltage (open base) | V_{CEO} | max. | 15 V ²⁾ |
| Emitter-base voltage (open collector) | V_{EBO} | max. | 2.5 V |

Currents

| | | | |
|---|----------|------|-------|
| Collector current (d.c.) | I_C | max. | 25 mA |
| Collector current (peak value; $f > 1$ MHz) | I_{CM} | max. | 50 mA |

Power dissipation

| | | | |
|--|-----------|------|--------|
| Total power dissipation up to $T_{amb} = 25^\circ C$ | P_{tot} | max. | 200 mW |
|--|-----------|------|--------|

Temperatures

| | | | |
|----------------------|-----------|-------------|----------------|
| Storage temperature | T_{stg} | -65 to +200 | $^\circ C$ |
| Junction temperature | T_j | max. | 200 $^\circ C$ |

THERMAL RESISTANCE

| | | | |
|--------------------------------------|--------------|---|--------------------|
| From junction to ambient in free air | $R_{th j-a}$ | = | 0.88 $^\circ C/mW$ |
| From junction to case | $R_{th j-c}$ | = | 0.58 $^\circ C/mW$ |

1) Limiting values according to the Absolute Maximum System as defined in IEC publication 134.

2) $I_C = 10$ mA

CHARACTERISTICS

$T_j = 25\text{ }^\circ\text{C}$ unless otherwise specified

Collector cut-off current

$I_E = 0; V_{CB} = 15\text{ V}$

$I_{CBO} < 10\text{ nA}$

Knee voltage

$I_C = 20\text{ mA}; I_B = \text{value for which}$
 $I_C = 22\text{ mA at } V_{CE} = 1\text{ V}$

$V_{CEK} < 0.75\text{ V}$

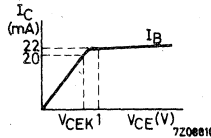

D.C. current gain

$I_C = 2\text{ mA}; V_{CE} = 1\text{ V}$

$h_{FE} \quad 25\text{ to }150$

$I_C = 25\text{ mA}; V_{CE} = 1\text{ V}$

$h_{FE} \quad 20\text{ to }125$

Transition frequency 1)

$I_C = 2\text{ mA}; V_{CE} = 5\text{ V}; f = 500\text{ MHz}$

$f_T > 1.0\text{ GHz}$
 typ. 1.1 GHz

$I_C = 25\text{ mA}; V_{CE} = 5\text{ V}; f = 500\text{ MHz}$

$f_T > 1.3\text{ GHz}$
 typ. 1.4 GHz

Collector capacitance at $f = 1\text{ MHz}$ 2)

$I_E = I_e = 0; V_{CB} = 10\text{ V}$

$C_C < 1.5\text{ pF}$

Feedback capacitance at $f = 1\text{ MHz}$ 1)

$I_C = 2\text{ mA}; V_{CE} = 5\text{ V}$

C_{re} typ. 0.6 pF
 $< 0.8\text{ pF}$

Noise figure 1)

$I_C = 2\text{ mA}; V_{CE} = 5\text{ V}$

$f = 100\text{ kHz}; \text{ optimum source resistance}$

$F < 4\text{ dB}$

$f = 200\text{ MHz}; \text{ optimum source impedance}$

$F < 3.5\text{ dB}$

$f = 500\text{ MHz}; R_S = 50\text{ }\Omega$

$F < 5\text{ dB}$

$f = 800\text{ MHz}; \text{ optimum source impedance}$

F typ. 5.5 dB

Power gain (not neutralized) 1)

$I_C = 14\text{ mA}; V_{CE} = 10\text{ V}; T_{amb} = 25\text{ }^\circ\text{C}$

| | | $f = 200$ | 800 | MHz |
|-------|------|-----------|-------|-----|
| G_p | $>$ | 21 | | dB |
| | typ. | 23 | 8 | dB |

1) Shield lead grounded.

2) Shield lead not connected.

BFY90

CHARACTERISTICS (continued)

$T_j = 25\text{ }^\circ\text{C}$ unless otherwise specified

Intermodulation characteristics ¹⁾

1. Output power at $f = 200\text{ MHz}$; $T_{amb} = 25\text{ }^\circ\text{C}$

$I_C = 14\text{ mA}$; $V_{CE} = 10\text{ V}$; V.S.W.R. at output < 2

$f_p = 202\text{ MHz}$; $f_q = 205\text{ MHz}$; $d_{im} = -30\text{ dB}$
measured at $f(2q-p) = 208\text{ MHz}$ (Channel 9)

$P_o > 10\text{ mW}$
typ. 12 mW

Test circuit:

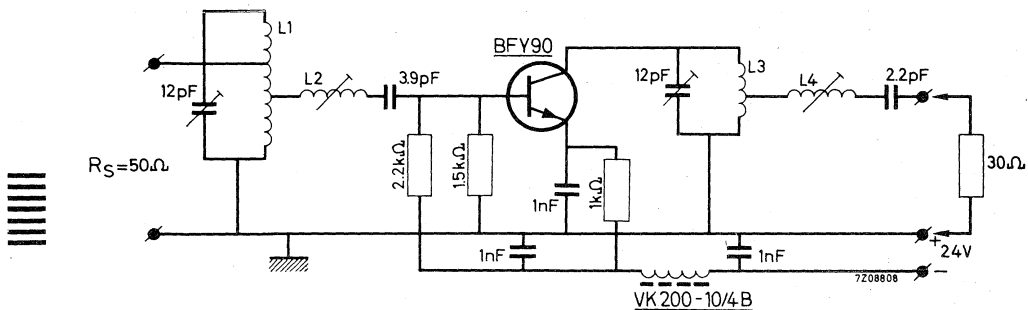

Coil data:

- L1 = 3 turns silver plated Cu wire (1.4 mm); winding pitch 2.7 mm; int. diam. 8 mm; taps at 0.5 turn and 1.5 turns from earth.
- L2 = 5.5 turns silver plated Cu wire (1.4 mm); winding pitch 2.2 mm; int. diam. 8 mm.
- L3 = 3 turns silver plated Cu wire (1.4 mm); winding pitch 3.3 mm; int. diam. 8 mm.
- L4 = 5.5 turns silver plated Cu wire (1.4 mm); winding pitch 2.2 mm; int. diam. 11 mm.

¹⁾ Shield lead grounded

CHARACTERISTICS (continued)

Basis of adjustment

The intermodulation at an intermodulation distortion of -30 dB is caused by h.f. output current - voltage clipping.

The maximum undistorted output power is realised, if

- a. Current and voltage clipping take place concurrently.

This occurs if

$$R_L = \frac{V_{CE} - V_{CEK}}{I_C},$$

in which V_{CEK} is the high frequency knee voltage.

- b. The h.f. collector current is as small as possible.

This is so if $-C_L = +C_{oe}$,

in which C_{oe} is the output capacitance of the transistor at short circuited input.

For maximum output power at an intermodulation distortion of -30 dB, the (experimentally found) values of R_L and C_L are:

$$R_L = 560 \Omega; C_L = -1.8 \text{ pF}$$

Adjustment procedure

1. Remove the transistor and connect a dummy consisting of a 560 Ω resistor in parallel with a 1.8 pF capacitor between the collector and emitter connections of the output circuit.
2. Tune and match the output circuit for zero reflection at 205 MHz (V.S.W.R. = 1). After this adjustment, no further change may be made in the output circuit.
3. Replace the dummy by the transistor. Tune and match the input circuit for maximum power gain and good band pass curve.
The V.S.W.R. of the output will then, in most cases, be ≤ 2 over the whole channel.
Corrections can be made by tuning L2; this will not disturb the band pass curve.

CHARACTERISTICS (continued)

$T_j = 25\text{ }^\circ\text{C}$ unless otherwise specified

Intermodulation characteristics ¹⁾

2. Output power at $f = 800\text{ MHz}$; $T_{amb} = 25\text{ }^\circ\text{C}$

$I_C = 14\text{ mA}$; $V_{CE} = 10\text{ V}$; V.S.W.R. at output < 2

$f_p = 798\text{ MHz}$; $f_q = 802\text{ MHz}$; $d_{im} = -30\text{ dB}$
 measured at $f(2q-p) = 806\text{ MHz}$ (Channel 62)

P_o typ. 12 mW

Test circuit:

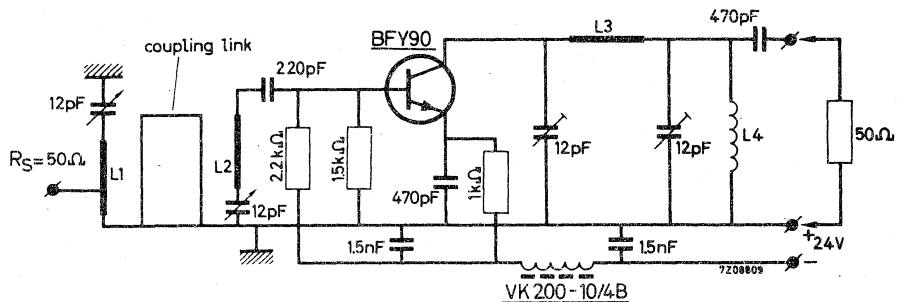

Coil data:

L1 = 24 mm x 6 mm x 0.5 mm silver plated Cu strip.

Tap of the input at 5 mm from earth.

L2 = 15 mm x 6 mm x 0.5 mm silver plated Cu strip.

L3 = 20 mm x 8 mm x 0.5 mm silver plated Cu strip.

L4 = 4 turns enamelled Cu wire (0.5 mm); winding pitch 1.5 mm; int. diam. 4 mm

Coupling link: 42 mm silver plated Cu wire (1 mm).

Basis of adjustment.

At 800 MHz no dummy can be used to adjust for optimum collector load because at these frequencies the impedance transformations of a dummy are too high. A small signal at the mid-channel frequency of 802 MHz is fed to the input and increased until clipping occurs; that is, until the output power no longer increases linearly with the input signal. This clipping can be eliminated by tuning the output circuit, thereby making the output power equal to

$$P_o = \frac{I_C (V_{CE} - V_{CEK})}{2} = 60\text{ mW}$$

The output circuit is adjusted for minimum intermodulation if the input signal is as small as possible at $P_o = 60\text{ mW}$.

After this adjustment has been made no further change may be made in the output circuit.

Adjust the input circuit for maximum power gain and good band pass curve.

The V.S.W.R. of the output is then ≤ 2 over the whole channel.

¹⁾ Shield lead grounded

CHARACTERISTICS (continued)

$T_j = 25\text{ }^\circ\text{C}$ unless otherwise specified

Intermodulation characteristics ¹⁾

3. Intermodulation distortion

$I_C = 14\text{ mA}$; $V_{CE} = 6\text{ V}$; $R_L = 37.5\text{ }\Omega$; $T_{amb} = 25\text{ }^\circ\text{C}$

$V_o = 100\text{ mV}$ at $f_p = 183\text{ MHz}$

$V_o = 100\text{ mV}$ at $f_q = 200\text{ MHz}$
measured at $f(2q-p) = 217\text{ MHz}$

d_{im} typ. -50 dB

Test circuit:

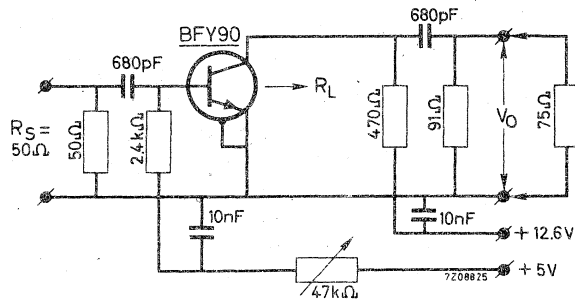

y parameters at $f = 500\text{ MHz}$ (common emitter) ¹⁾

$I_C = 2\text{ mA}$; $V_{CE} = 5\text{ V}$

Input conductance

g_{ie} typ. $16\text{ m}\Omega^{-1}$

Input capacitance

C_{ie} typ. 3.75 pF

Feedback admittance

$|y_{re}|$ typ. $1.55\text{ m}\Omega^{-1}$

Phase angle of feedback admittance

φ_{re} typ. 258°

Transfer admittance

$|y_{fe}|$ typ. $45\text{ m}\Omega^{-1}$

Phase angle of transfer admittance

φ_{fe} typ. 285°

Output conductance

g_{oe} typ. $0.19\text{ m}\Omega^{-1}$

Output capacitance

C_{oe} typ. 1.9 pF

Maximum unilateralised power gain

$$G_{UM} = \frac{|y_{fe}|^2}{4g_{ie}g_{oe}}$$

$I_C = 2\text{ mA}$; $V_{CE} = 5\text{ V}$; $f = 500\text{ MHz}$

G_{UM} typ. 22 dB

¹⁾ Shield lead grounded

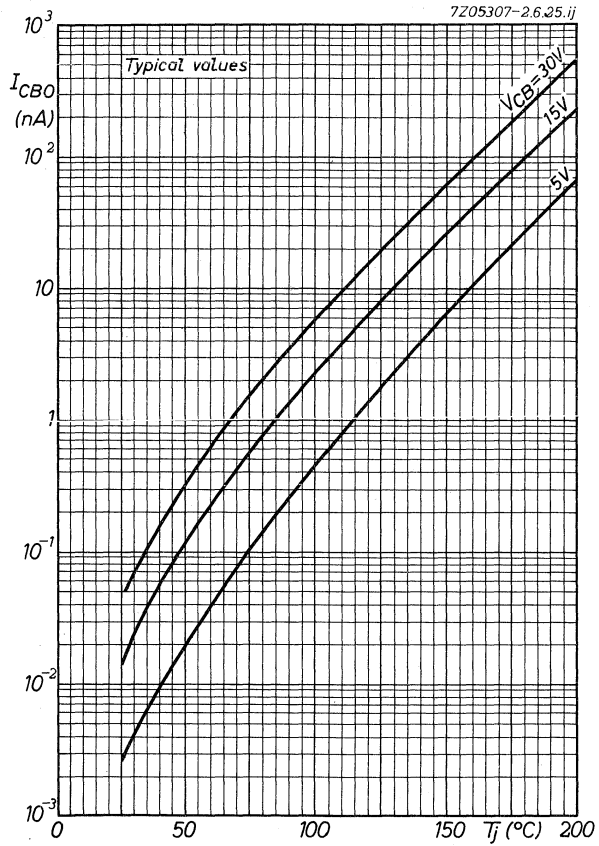

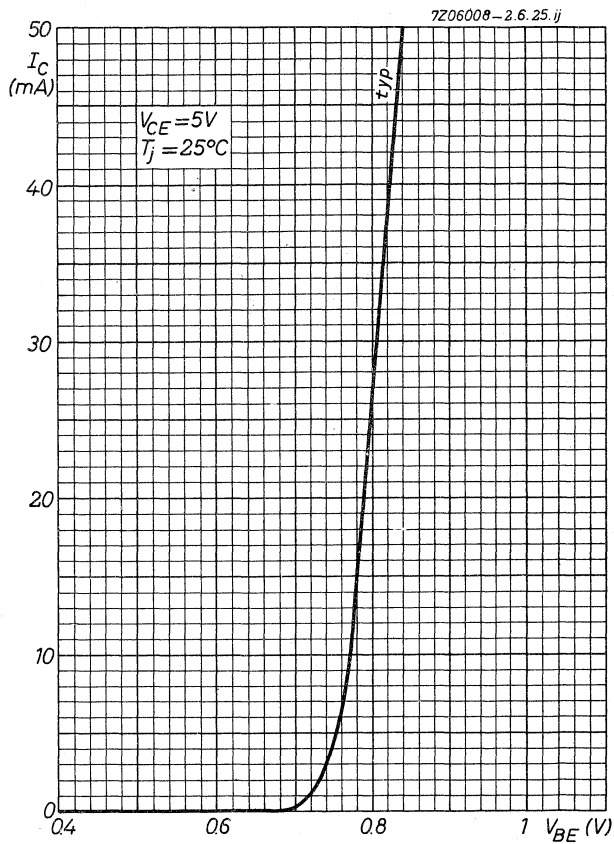

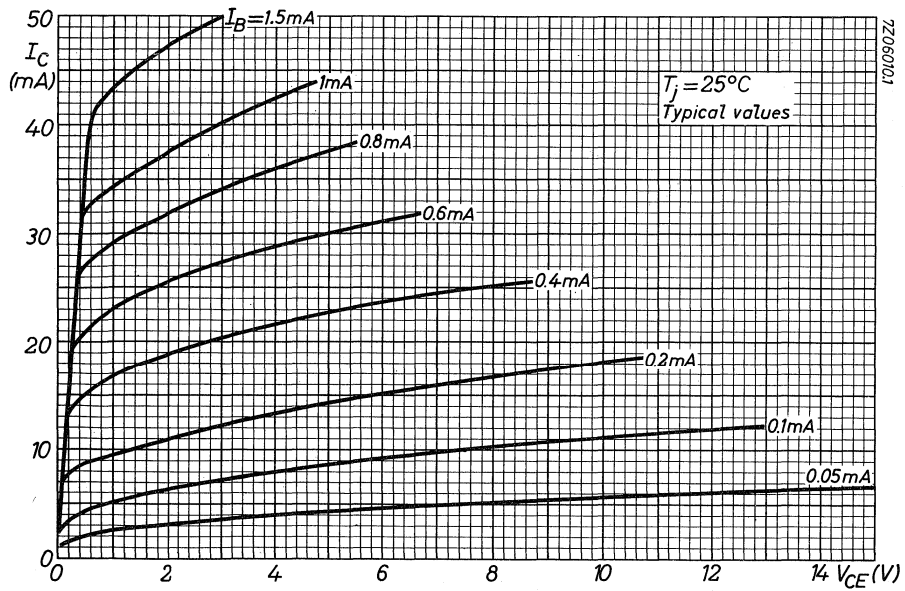
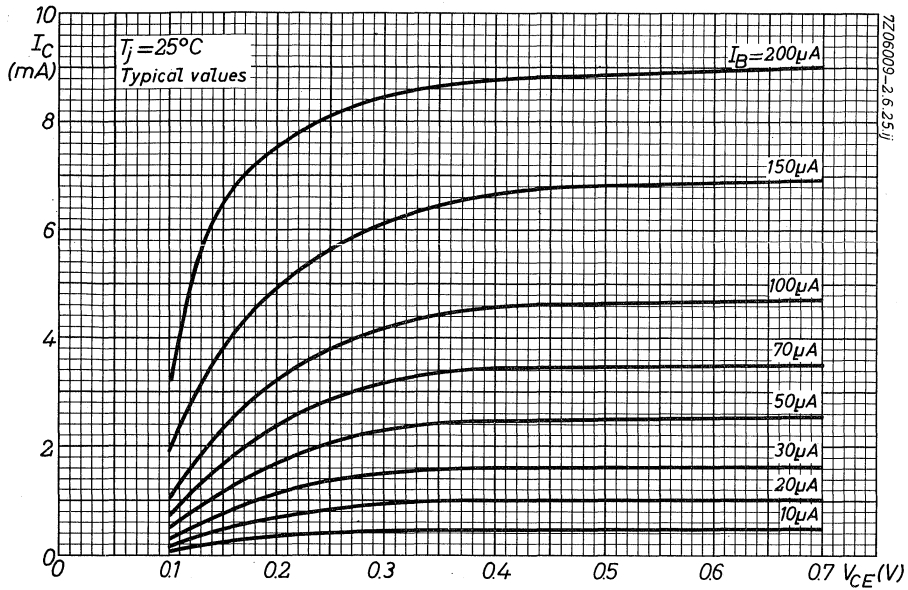

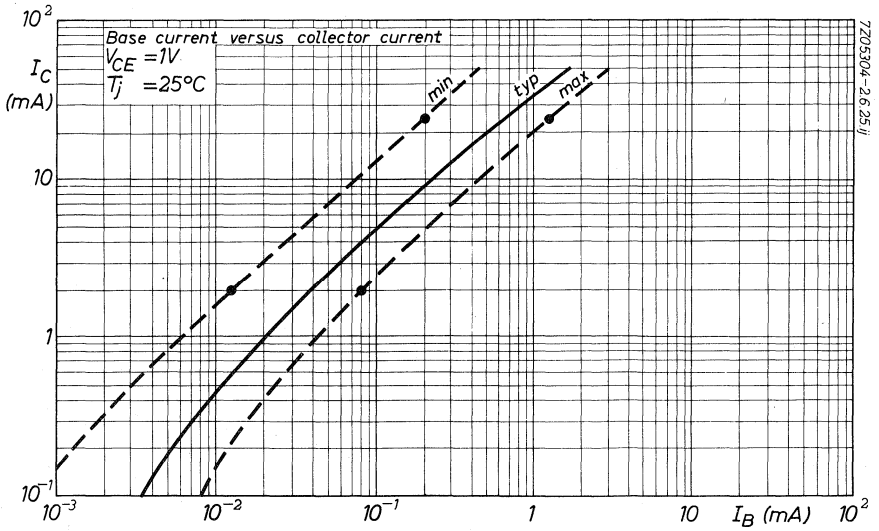
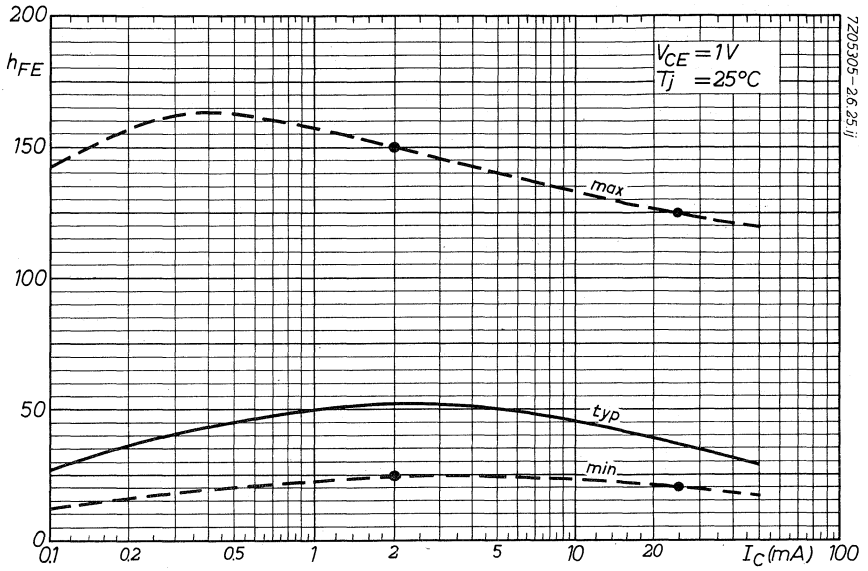

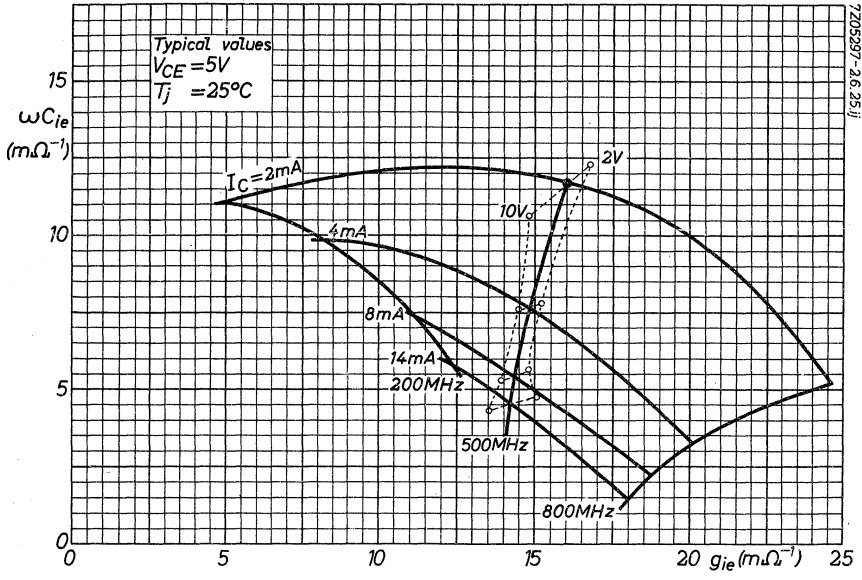

7205297-26,25j

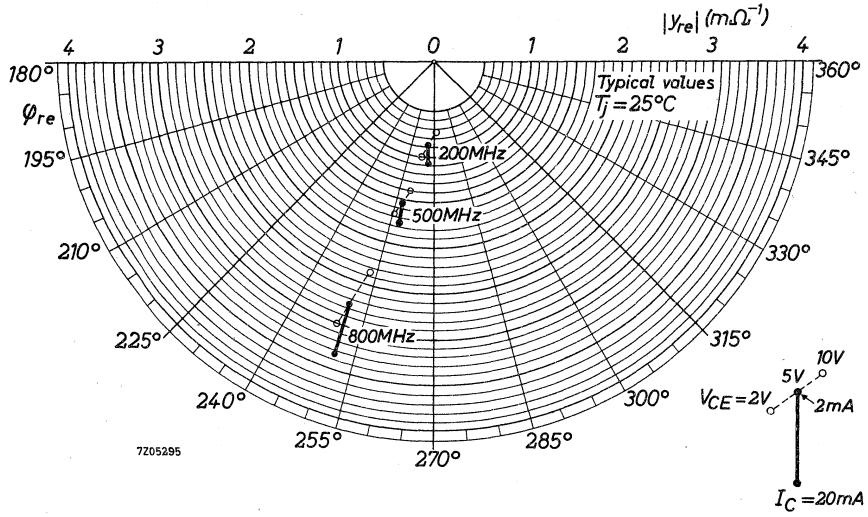

7205295

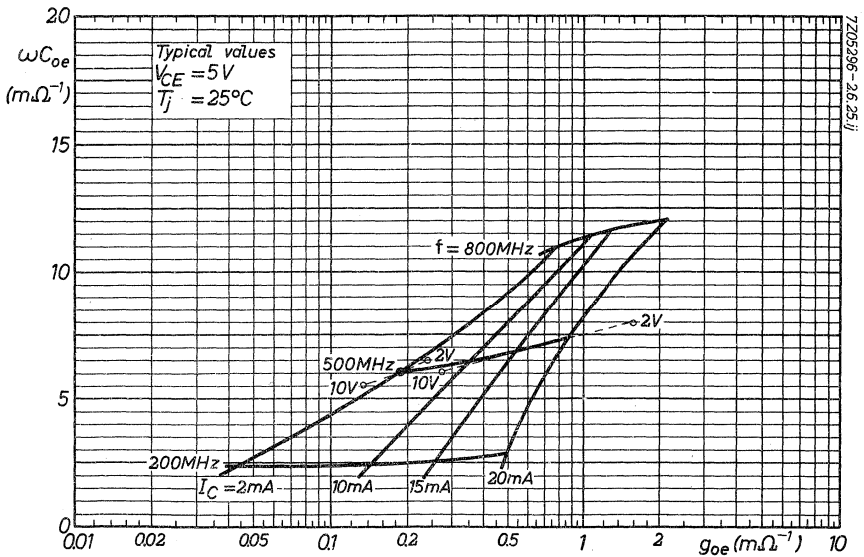
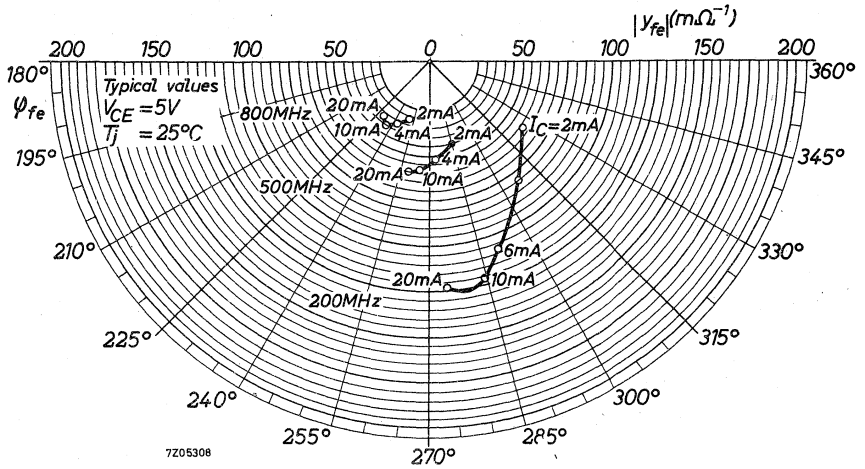

7Z08806.1

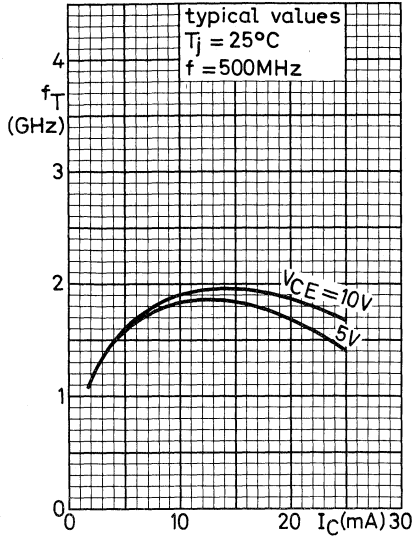

7Z08807.1

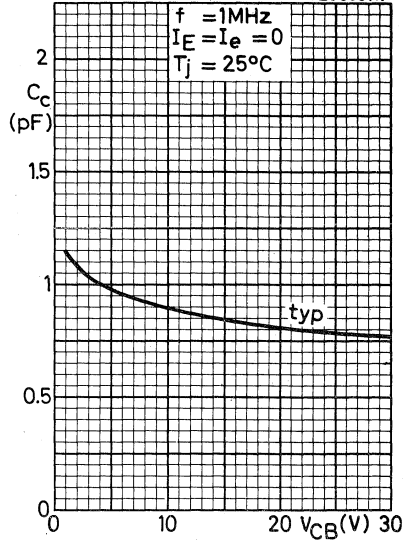

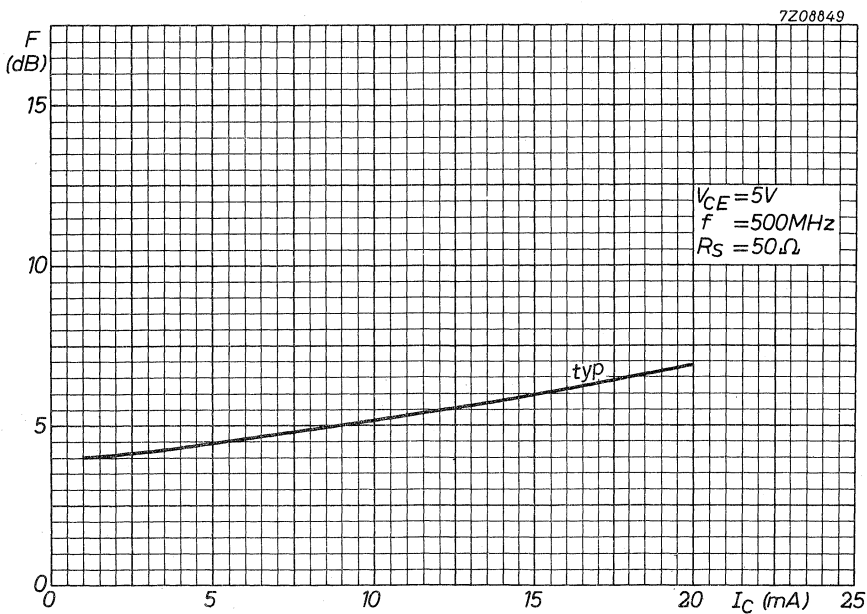
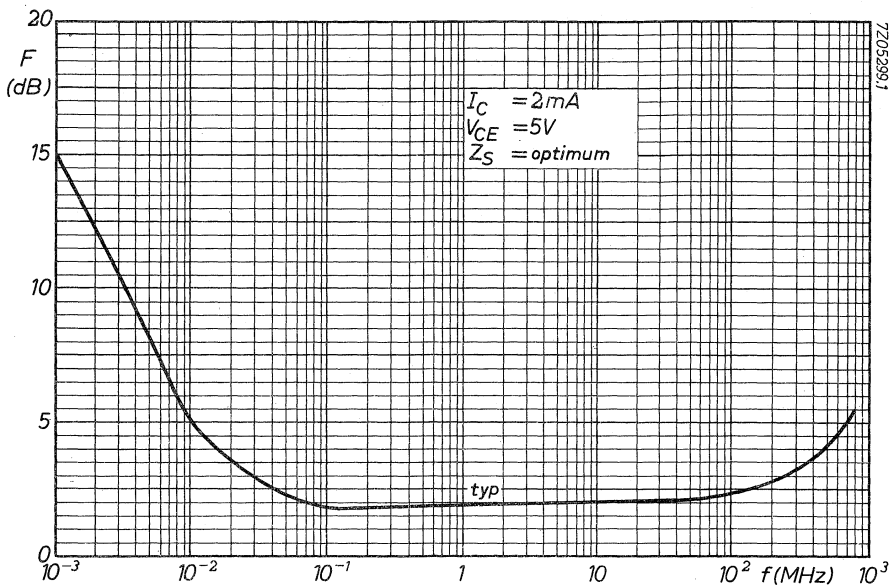

APPLICATION INFORMATION

Performance of channel - and band amplifiers ¹⁾

| Frequency range | Channel 9 202-209 | | | Channel 55 742-750 | Band II 87.5-108 | Band III 174-230 | MHz |
|---|----------------------|-------|-------|--------------------------|------------------------|------------------------|----------|
| Transistor used in final stage | BFW16 | BFW16 | BFY90 | BFW16 | BFW16 | BFW16 | |
| driver stage | BFW16 | BFY90 | BF183 | BFW16 | | BFW16 | |
| second stage | | | | BFY90 | | | |
| first stage | BFY90 | BF200 | BF200 | BFY90 | BFY90 | BFY90 | |
| <u>Output power at</u> | | | | | | | |
| $d_{im} = -30$ dB | 150 ²⁾ | 60 | 10 | 80 | | | mW |
| $d_{im} = -50$ dB | | | | | 25 | | mW |
| $d_{im} = -60$ dB | | | | | | 10 | mW |
| <u>Power gain</u> | 44 | 48 | 49 | 30 | 42.5 | 39 | dB |
| <u>Noise figure</u> | 6.3 | 5.7 | 5.5 | 7 | 6.0-6.5 | 6.2-6.7 | dB |
| <u>V.S.W.R.</u> over the whole channel or band | | | | | | | |
| for the input | < 2 | < 2 | < 2 | < 2 | < 2 | < 2 | |
| for the output | < 2 | < 2 | < 2 | < 2 | < 2 | < 2 | |
| <u>Load impedance</u> | 30 | 30 | 30 | 50 | 30 | 30 | Ω |
| <u>Source impedance</u> | 60 | 60 | 60 | 50 | 60 | 60 | Ω |

1) Application information bulletins with detailed informations of all these amplifiers and a study of intermodulation are available on request.

2) $V_O = 2.2$ V over $R_L = 30 \Omega$ or
 $V_O = 3$ V over $R_L = 60 \Omega$.

SILICON PLANAR EPITAXIAL TRANSISTOR

N-P-N transistor in TO-72 metal envelope with insulated electrodes and a shield lead connected to the case. The 2N918 is primarily intended for low power amplifiers and oscillators in the v.h.f. and u.h.f. ranges for industrial service.

QUICK REFERENCE DATA

| | | | |
|--|-----------|------|----------------------|
| Collector-base voltage (open emitter) | V_{CBO} | max. | 30 V |
| Collector-emitter voltage (open base) | V_{CEO} | max. | 15 V |
| Collector current (d. c.) | I_C | max. | 50 mA |
| Total power dissipation up to $T_{amb} = 25^\circ\text{C}$ | P_{tot} | max. | 200 mW |
| Junction temperature | T_j | max. | 200 $^\circ\text{C}$ |
| Transition frequency $I_C = 6\text{ mA}; V_{CE} = 10\text{ V}$ | f_T | > | 900 MHz |
| Maximum unilaterised power gain $I_C = 6\text{ mA}; V_{CE} = 12\text{ V}; f = 200\text{ MHz}$ | G_{UM} | typ. | 36 dB |
| Noise figure at $f = 60\text{ MHz}$ $I_C = 1\text{ mA}; V_{CE} = 6\text{ V}; R_S = 400\ \Omega$ | F | < | 6 dB |

MECHANICAL DATA

Dimensions in mm

TO-72

Insulated electrodes

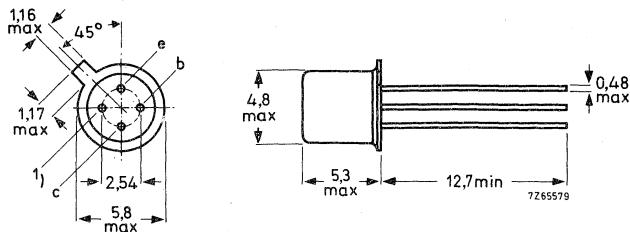

1) = shield lead (connected to case)

Accessories available: 56246, 56263

RATINGS Limiting values in accordance with the Absolute Maximum System (IEC134)

Voltages

| | | | |
|---|-----------|------|------|
| Collector-base voltage (open emitter) | V_{CBO} | max. | 30 V |
| Collector-emitter voltage (open base) $I_C = 3 \text{ mA}$ | V_{CEO} | max. | 15 V |
| Emitter-base voltage (open collector) | V_{EBO} | max. | 3 V |

Currents

| | | | |
|---------------------------|-------|------|-------|
| Collector current (d. c.) | I_C | max. | 50 mA |
|---------------------------|-------|------|-------|

Power dissipation

| | | | |
|---|-----------|------|--------|
| Total power dissipation up to $T_{amb} = 25 \text{ }^\circ\text{C}$ | P_{tot} | max. | 200 mW |
|---|-----------|------|--------|

Temperatures

| | | | |
|----------------------|-----------|-------------|----------------------|
| Storage temperature | T_{stg} | -65 to +200 | $^\circ\text{C}$ |
| Junction temperature | T_j | max. | 200 $^\circ\text{C}$ |

THERMAL RESISTANCE

| | | | |
|--------------------------------------|----------------------|---|---------------------------------|
| From junction to ambient in free air | $R_{th \text{ j-a}}$ | = | 0.88 $^\circ\text{C}/\text{mW}$ |
| From junction to case | $R_{th \text{ j-c}}$ | = | 0.58 $^\circ\text{C}/\text{mW}$ |

CHARACTERISTICS $T_j = 25\text{ }^\circ\text{C}$ unless otherwise specified

All measurements taken with ungrounded shield lead

Collector cut-off current

| | | |
|--|-----------|-------------------|
| $I_E = 0; V_{CB} = 15\text{ V}$ | I_{CBO} | < 10 nA |
| $I_E = 0; V_{CB} = 15\text{ V}; T_j = 150\text{ }^\circ\text{C}$ | I_{CBO} | < 1 μA |

Saturation voltages

| | | |
|---|-------------|---------|
| $I_C = 10\text{ mA}; I_B = 1\text{ mA}$ | V_{CEsat} | < 0.4 V |
| | V_{BEsat} | < 1 V |

D. C. current gain

| | | |
|--|----------|------|
| $I_C = 3\text{ mA}; V_{CE} = 1\text{ V}$ | h_{FE} | > 20 |
|--|----------|------|

Collector capacitance at $f = 140\text{ kHz}$

| | | |
|---------------------------------------|-------|----------|
| $I_E = I_e = 0; V_{CB} = 10\text{ V}$ | C_c | < 1.7 pF |
| $I_E = I_e = 0; V_{CB} = 0$ | C_c | < 3.0 pF |

Emitter capacitance at $f = 140\text{ kHz}$

| | | |
|--|-------|----------|
| $I_C = I_c = 0; V_{EB} = 0.5\text{ V}$ | C_e | < 2.0 pF |
|--|-------|----------|

Transition frequency

| | | |
|--|-------|-----------|
| $I_C = 6\text{ mA}; V_{CE} = 10\text{ V}^1)$ | f_T | > 900 MHz |
|--|-------|-----------|

Noise figure at $f = 60\text{ MHz}$

| | | |
|---|---|--------|
| $I_C = 1\text{ mA}; V_{CE} = 6\text{ V}; R_S = 400\ \Omega$ | F | < 6 dB |
|---|---|--------|

Oscillator power output at $f = 500\text{ MHz}$

| | | |
|--|-------|---------|
| $-I_E = 8\text{ mA}; V_{CB} = 15\text{ V}$ | P_o | > 30 mW |
|--|-------|---------|

Maximum unilateralised power gain

| | | |
|---|----------|------------|
| $G_{UM} = \frac{ y_{fe} ^2}{4g_{ie}g_{oe}}$ | G_{UM} | typ. 36 dB |
| $I_C = 6\text{ mA}; V_{CE} = 12\text{ V}; f = 200\text{ MHz}$ | | |

1) JEDEC registration: $I_C = 4\text{ mA}; V_{CE} = 10\text{ V}; f_T > 600\text{ MHz}$.

CHARACTERISTICS (continued)

$T_j = 25\text{ }^\circ\text{C}$

Available power gain at $f = 200\text{ MHz}$

$I_C = 6\text{ mA}$

$G_p > 15\text{ dB}$

Basic circuit for measuring the available neutralised power gain

Grounded shield lead

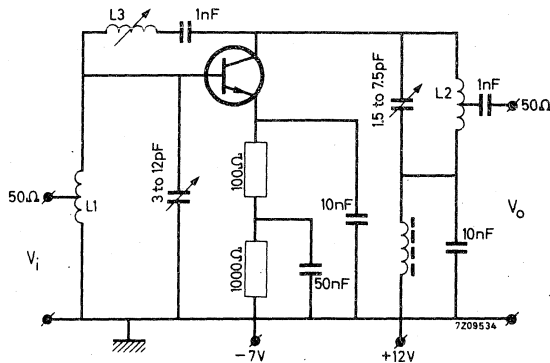

L1 = 3.5 turns tinned Cu wire, 1.3 mm
d = 8 mm; length = 11 mm

Tap at ≈ 2 turns from earth side

L2 = 8 turns tinned Cu wire, 1.3 mm
d = 3 mm; length = 22 mm

Tap at 1 turn from earth side

L3 = 0.4 to 0.65 μH

SILICON PLANAR TRANSISTOR

N-P-N double diffused transistor in a TO-39 metal envelope with the collector connected to the case. The 2N1613 is intended for use in a wide variety of applications, such as d.c. and high frequency amplifiers and switching applications.

QUICK REFERENCE DATA

| | | |
|---|-----------|---------------------------|
| Collector-base voltage (open emitter) | V_{CBO} | max. 75 V |
| Collector-emitter voltage ($R_{BE} < 10 \Omega$) | V_{CER} | max. 50 V |
| Collector current (peak value) | I_{CM} | max. 1 A |
| Total power dissipation up to $T_{amb} = 25 \text{ }^\circ\text{C}$ | P_{tot} | max. 0.8 W |
| Junction temperature | T_j | max. 200 $^\circ\text{C}$ |
| D.C. current gain | | |
| $I_C = 0.1 \text{ mA}; V_{CE} = 10 \text{ V}$ | h_{FE} | > 20 |
| $I_C = 10 \text{ mA}; V_{CE} = 10 \text{ V}$ | h_{FE} | > 35 |
| $I_C = 150 \text{ mA}; V_{CE} = 10 \text{ V}$ | h_{FE} | 40 to 120 |
| Transition frequency | | |
| $I_C = 50 \text{ mA}; V_{CE} = 10 \text{ V}$ | f_T | > 60 MHz |

MECHANICAL DATA

Dimensions in mm

Collector connected to case

TO-39

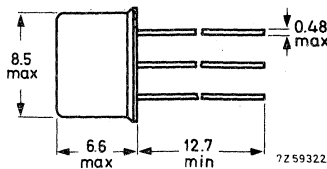
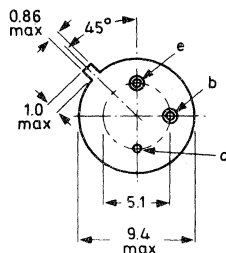

max. lead diameter is guaranteed only for 12.7 mm

Accessories available: 56218, 56245

RATINGS (Limiting values) ¹⁾Voltages

| | | | |
|--|-----------|------|------|
| Collector-base voltage (open emitter) | V_{CBO} | max. | 75 V |
| Collector-emitter voltage ($R_{BE} < 10 \Omega$) | V_{CER} | max. | 50 V |
| Emitter-base voltage (open collector) | V_{EBO} | max. | 7 V |

Current

| | | | |
|--------------------------------|----------|------|-----|
| Collector current (peak value) | I_{CM} | max. | 1 A |
|--------------------------------|----------|------|-----|

Power dissipation

| | | | |
|---|-----------|------|-------|
| Total power dissipation up to $T_{amb} = 25 \text{ }^\circ\text{C}$ | P_{tot} | max. | 0.8 W |
| up to $T_{case} = 100 \text{ }^\circ\text{C}$ | P_{tot} | max. | 1.7 W |
| up to $T_{case} = 25 \text{ }^\circ\text{C}$ | P_{tot} | max. | 3.0 W |

Temperatures

| | | | |
|----------------------|-----------|-------------|----------------------|
| Storage temperature | T_{stg} | -65 to +200 | $^\circ\text{C}$ |
| Junction temperature | T_j | max. | 200 $^\circ\text{C}$ |

THERMAL RESISTANCE

| | | | |
|--------------------------------------|--------------|---|------------------------|
| From junction to ambient in free air | $R_{th j-a}$ | = | 220 $^\circ\text{C/W}$ |
| From junction to case | $R_{th j-c}$ | = | 58 $^\circ\text{C/W}$ |

¹⁾ Limiting values according to the Absolute Maximum System as defined in IEC publication 134.

CHARACTERISTICS $T_{amb} = 25\text{ }^{\circ}\text{C}$ unless otherwise specifiedCollector cut-off current

| | | | |
|--|-----------|---|------------------|
| $I_E = 0; V_{CB} = 60\text{ V}$ | I_{CBO} | < | 10 nA |
| $I_E = 0; V_{CB} = 60\text{ V}; T_{amb} = 150\text{ }^{\circ}\text{C}$ | I_{CBO} | < | 10 μA |

Emitter cut-off current

| | | | |
|--------------------------------|-----------|---|-------|
| $I_C = 0; V_{EB} = 5\text{ V}$ | I_{EBO} | < | 10 nA |
|--------------------------------|-----------|---|-------|

Collector-emitter sustaining voltage

| | | | |
|--|---------------|---|--------------------|
| $I_C = 100\text{ mA}; R_{BE} < 10\text{ }\Omega$ | $V_{CERsust}$ | > | 50 V ¹⁾ |
|--|---------------|---|--------------------|

Saturation voltages

| | | | |
|---|-------------|---|---------------------|
| $I_C = 150\text{ mA}; I_B = 15\text{ mA}$ | V_{CEsat} | < | 1.5 V ¹⁾ |
| | V_{BEsat} | < | 1.3 V ¹⁾ |

D.C. current gain

| | | | |
|---|----------|---|-------------------------|
| $I_C = 0.1\text{ mA}; V_{CE} = 10\text{ V}$ | h_{FE} | > | 20 |
| $I_C = 10\text{ mA}; V_{CE} = 10\text{ V}$ | h_{FE} | > | 35 ¹⁾ |
| $I_C = 150\text{ mA}; V_{CE} = 10\text{ V}$ | h_{FE} | | 40 to 120 ¹⁾ |
| $I_C = 500\text{ mA}; V_{CE} = 10\text{ V}$ | h_{FE} | > | 20 ¹⁾ |
| $I_C = 10\text{ mA}; V_{CE} = 10\text{ V}; T_{amb} = -55\text{ }^{\circ}\text{C}$ | h_{FE} | > | 20 |

h parameters at $f = 1\text{ kHz}$ $-I_E = 1\text{ mA}; V_{CB} = 5\text{ V}$

| | | |
|--------------------------|----------|-----------------------------|
| Input impedance | h_{ib} | 24 to 34 Ω |
| Reverse voltage transfer | h_{rb} | < 3 10^{-4} |
| Output admittance | h_{ob} | 0.1 to 0.5 $\mu\Omega^{-1}$ |

 $-I_E = 5\text{ mA}; V_{CB} = 10\text{ V}$

| | | |
|--------------------------|----------|-----------------------------|
| Input impedance | h_{ib} | 4 to 8 Ω |
| Reverse voltage transfer | h_{rb} | < 3 10^{-4} |
| Output admittance | h_{ob} | 0.1 to 1.0 $\mu\Omega^{-1}$ |

Small signal current gain

| | | |
|---|----------|-----------|
| $I_C = 1\text{ mA}; V_{CE} = 5\text{ V}$ | h_{fe} | 30 to 100 |
| $I_C = 5\text{ mA}; V_{CE} = 10\text{ V}$ | h_{fe} | 35 to 150 |

¹⁾ Measured under pulse conditions to avoid excessive dissipation.Pulse duration $t < 300\text{ }\mu\text{s}$, duty cycle $\delta < 0.01$

CHARACTERISTICS (continued) $T_{amb} = 25\text{ }^{\circ}\text{C}$ unless otherwise specifiedTransition frequency $I_C = 50\text{ mA}; V_{CE} = 10\text{ V}$ $f_T > 60\text{ MHz}$ Collector capacitance at $f = 1\text{ MHz}$ $I_E = I_e = 0; V_{CB} = 10\text{ V}$ $C_C < 25\text{ pF}$ Emitter capacitance at $f = 1\text{ MHz}$ $I_C = I_c = 0; V_{EB} = 0.5\text{ V}$ $C_e < 80\text{ pF}$ Noise figure at $f = 1\text{ kHz}$ $I_C = 0.3\text{ mA}; V_{CE} = 10\text{ V}$
 $R_S = 510\text{ }\Omega; \text{Bandwidth: } 200\text{ Hz}$ $F < 12\text{ dB}$ 

SILICON PLANAR TRANSISTOR

N-P-N double diffused transistor in a TO-39 metal envelope with the collector connected to the case. The 2N1711 is intended for use in a wide variety of applications, such as d.c. and high frequency amplifiers and switching applications.

| QUICK REFERENCE DATA | | | |
|--|-----------|------|----------------|
| Collector-base voltage (open emitter) | V_{CBO} | max. | 75 V |
| Collector-emitter voltage ($R_{BE} < 10 \Omega$) | V_{CER} | max. | 50 V |
| Collector current (peak value) | I_{CM} | max. | 1 A |
| Total power dissipation up to $T_{amb} = 25^\circ C$ | P_{tot} | max. | 0.8 W |
| Junction temperature | T_j | max. | 200 $^\circ C$ |
| D.C. current gain | | | |
| $I_C = 0.1 \text{ mA}; V_{CE} = 10 \text{ V}$ | h_{FE} | > | 35 |
| $I_C = 10 \text{ mA}; V_{CE} = 10 \text{ V}$ | h_{FE} | > | 75 |
| $I_C = 150 \text{ mA}; V_{CE} = 10 \text{ V}$ | h_{FE} | | 100 to 300 |
| Transition frequency | | | |
| $I_C = 50 \text{ mA}; V_{CE} = 10 \text{ V}$ | f_T | > | 70 MHz |

MECHANICAL DATA

Dimensions in mm

Collector connected to case

TO-39

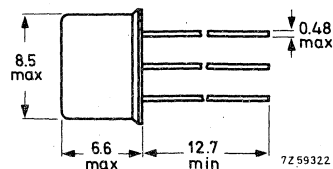
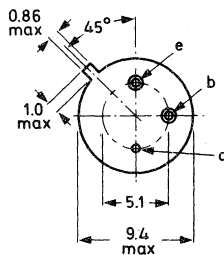

max. lead diameter is guaranteed only for 12.7 mm

Accessories available: 56218, 56245

RATINGS (Limiting values) ¹⁾Voltages

| | | | |
|--|-----------|------|------|
| Collector-base voltage (open emitter) | V_{CBO} | max. | 75 V |
| Collector-emitter voltage ($R_{BE} < 10 \Omega$) | V_{CER} | max. | 50 V |
| Emitter-base voltage (open collector) | V_{EBO} | max. | 7 V |

Current

| | | | |
|--------------------------------|----------|------|-----|
| Collector current (peak value) | I_{CM} | max. | 1 A |
|--------------------------------|----------|------|-----|

Power dissipation

| | | | |
|--|-----------|------|-------|
| Total power dissipation up to $T_{amb} = 25^\circ C$ | P_{tot} | max. | 0.8 W |
| up to $T_{case} = 100^\circ C$ | P_{tot} | max. | 1.7 W |
| up to $T_{case} = 25^\circ C$ | P_{tot} | max. | 3.0 W |

Temperatures

| | | | |
|----------------------|-----------|-------------|------------|
| Storage temperature | T_{stg} | -65 to +200 | $^\circ C$ |
| Junction temperature | T_j | max. 200 | $^\circ C$ |

THERMAL RESISTANCE

| | | | |
|--------------------------------------|--------------|---|------------------|
| From junction to ambient in free air | $R_{th j-a}$ | = | 220 $^\circ C/W$ |
| From junction to case | $R_{th j-c}$ | = | 58 $^\circ C/W$ |

¹⁾ Limiting values according to the Absolute Maximum System as defined in IEC publication 134.

CHARACTERISTICS $T_{amb} = 25\text{ }^{\circ}\text{C}$ unless otherwise specifiedCollector cut-off current $I_E = 0; V_{CB} = 60\text{ V}$ ICBO < 10 nA $I_E = 0; V_{CB} = 60\text{ V}; T_{amb} = 150\text{ }^{\circ}\text{C}$ ICBO < 10 μA Emitter cut-off current $I_C = 0; V_{EB} = 5\text{ V}$ IEBO < 5 nACollector-emitter sustaining voltage $I_C = 100\text{ mA}; R_{BE} < 10\text{ }\Omega$ VCEsust > 50 V¹⁾Saturation voltages $I_C = 150\text{ mA}; I_B = 15\text{ mA}$ VCEsat < 1.5 V¹⁾VBEsat < 1.3 V¹⁾D.C. current gain $I_C = 10\text{ }\mu\text{A}; V_{CE} = 10\text{ V}$ hFE > 20 $I_C = 0.1\text{ mA}; V_{CE} = 10\text{ V}$ hFE > 35 $I_C = 10\text{ mA}; V_{CE} = 10\text{ V}$ hFE > 75¹⁾ $I_C = 150\text{ mA}; V_{CE} = 10\text{ V}$ hFE 100 to 300¹⁾ $I_C = 500\text{ mA}; V_{CE} = 10\text{ V}$ hFE > 40¹⁾ $I_C = 10\text{ mA}; V_{CE} = 10\text{ V}; T_{amb} = -55\text{ }^{\circ}\text{C}$ hFE > 35h parameters at f = 1 kHz $-I_E = 1\text{ mA}; V_{CB} = 5\text{ V}$ Input impedance h_{ib} 24 to 34 Ω Reverse voltage transfer h_{rb} < 5 10^{-4} Output admittance h_{ob} 0.1 to 0.5 $\mu\Omega^{-1}$ $-I_E = 5\text{ mA}; V_{CB} = 10\text{ V}$ Input impedance h_{ib} 4 to 8 Ω Reverse voltage transfer h_{rb} < 5 10^{-4} Output admittance h_{ob} 0.1 to 1.0 $\mu\Omega^{-1}$ Small signal current gain $I_C = 1\text{ mA}; V_{CE} = 5\text{ V}$ h_{fe} 50 to 200 $I_C = 5\text{ mA}; V_{CE} = 10\text{ V}$ h_{fe} 70 to 300¹⁾ Measured under pulse conditions to avoid excessive dissipation.Pulse duration $t < 300\text{ }\mu\text{s}$, duty cycle $\delta < 0.01$

CHARACTERISTICS (continued) $T_{\text{amb}} = 25\text{ }^{\circ}\text{C}$ unless otherwise specifiedTransition frequency

$$I_C = 50\text{ mA}; V_{CE} = 10\text{ V}$$

$$f_T > 70\text{ MHz}$$

Collector capacitance at $f = 1\text{ MHz}$

$$I_E = I_e = 0; V_{CB} = 10\text{ V}$$

$$C_c < 25\text{ pF}$$

Emitter capacitance at $f = 1\text{ MHz}$

$$I_C = I_c = 0; V_{EB} = 0.5\text{ V}$$

$$C_e < 80\text{ pF}$$

Noise figure at $f = 1\text{ kHz}$

$$I_C = 0.3\text{ mA}; V_{CE} = 10\text{ V}$$
$$R_S = 510\text{ }\Omega; \text{Bandwidth: } 200\text{ Hz}$$

$$F < 8\text{ dB}$$



SILICON TRANSISTOR

High voltage n-p-n transistor in a TO-39 metal envelope with the collector connected to the case.
 It is intended for use in high performance amplifier, oscillator and switching applications.

| QUICK REFERENCE DATA | | |
|--|-----------|---------------------------|
| Collector-base voltage (open emitter) | V_{CBO} | max. 120 V |
| Collector-emitter voltage ($R_{BE} \leq 10 \Omega$) | V_{CER} | max. 100 V |
| Collector current (d.c.) | I_C | max. 500 mA |
| Total power dissipation up to $T_{case} = 25 \text{ }^\circ\text{C}$ | P_{tot} | max. 3.0 W |
| Junction temperature | T_j | max. 200 $^\circ\text{C}$ |
| D.C. current gain | | |
| $I_C = 0.1 \text{ mA}; V_{CE} = 10 \text{ V}$ | h_{FE} | > 20 |
| $I_C = 10 \text{ mA}; V_{CE} = 10 \text{ V}; T = -55 \text{ }^\circ\text{C}$ | h_{FE} | > 20 |
| $I_C = 10 \text{ mA}; V_{CE} = 10 \text{ V}$ | h_{FE} | > 35 |
| $I_C = 150 \text{ mA}; V_{CE} = 10 \text{ V}$ | h_{FE} | 40 to 120 |

MECHANICAL DATA

Dimensions in mm

Collector connected to case

TO-39

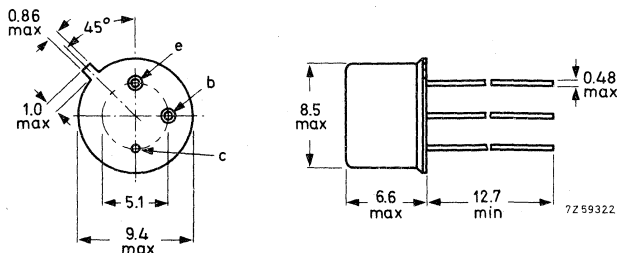

Accessories supplied on request: 56218; 56245

CHARACTERISTICS

$T_{amb} = 25\text{ }^{\circ}\text{C}$ unless otherwise specified

Collector cut-off current

| | | |
|--|-----------|--------------------|
| $I_E = 0; V_{CB} = 90\text{ V}$ | I_{CBO} | < 10 nA |
| $I_E = 0; V_{CB} = 90\text{ V}; T_{amb} = 150\text{ }^{\circ}\text{C}$ | I_{CBO} | < 15 μA |

Emitter cut-off current

| | | |
|--------------------------------|-----------|---------|
| $I_C = 0; V_{EB} = 5\text{ V}$ | I_{EBO} | < 10 nA |
|--------------------------------|-----------|---------|

Collector-emitter sustaining voltage ¹⁾

| | | |
|---|-----------------------|---------|
| $I_C = 100\text{ mA}; R_{BE} \geq 10\text{ }\Omega$ | $V_{CER\text{ sust}}$ | > 100 V |
| $I_C = 30\text{ mA}; I_B = 0$ | $V_{CEO\text{ sust}}$ | > 80 V |

Saturation voltages ¹⁾

| | | |
|---|---------------------|---------|
| $I_C = 150\text{ mA}; I_B = 15\text{ mA}$ | $V_{CE\text{ sat}}$ | < 5.0 V |
| | $V_{BE\text{ sat}}$ | < 1.3 V |
| $I_C = 50\text{ mA}; I_B = 5\text{ mA}$ | $V_{CE\text{ sat}}$ | < 1.2 V |
| | $V_{BE\text{ sat}}$ | < 0.9 V |

Breakdown voltages

| | | |
|---|-----------------------|---------|
| $I_E = 0; I_C = 100\text{ }\mu\text{A}$ | $V_{(BR)\text{ CBO}}$ | > 120 V |
| $I_C = 0; I_E = 100\text{ }\mu\text{A}$ | $V_{(BR)\text{ EBO}}$ | > 7.0 V |

D.C. current gain

| | | |
|---|----------|-----------|
| $I_C = 0.1\text{ mA}; V_{CE} = 10\text{ V}$ | h_{FE} | > 20 |
| $I_C = 10\text{ mA}; V_{CE} = 10\text{ V}; T = -55\text{ }^{\circ}\text{C}$ | h_{FE} | > 20 |
| $I_C = 10\text{ mA}; V_{CE} = 10\text{ V} 1)$ | h_{FE} | > 35 |
| $I_C = 150\text{ mA}; V_{CE} = 10\text{ V} 1)$ | h_{FE} | 40 to 120 |

¹⁾ Measured under pulsed conditions to avoid excessive dissipation.
Pulse duration $t \leq 300\text{ }\mu\text{s}$, duty cycle $\delta < 0.02$

CHARACTERISTICS (continued)

$T_{amb} = 25\text{ }^{\circ}\text{C}$ unless otherwise specified

h parameters at $f = 1\text{ kHz}$ (common base)

$I_C = 1\text{ mA}; V_{CE} = 5\text{ V}$

Input impedance

h_{ib} 20 to 30 Ω

Reverse voltage transfer ratio

h_{rb} 1.25 10^{-4}

Output conductance

h_{ob} 0.5 $\mu\Omega^{-1}$

$I_C = 5\text{ mA}; V_{CE} = 10\text{ V}$

Input impedance

h_{ib} 4 to 8 Ω

Reverse voltage transfer ratio

h_{rb} 1.50 10^{-4}

Output conductance

h_{ob} 0.5 $\mu\Omega^{-1}$

Small signal current gain (common emitter)

$I_C = 1\text{ mA}; V_{CE} = 5\text{ V}; f = 1\text{ kHz}$

h_{fe} 30 to 100

$I_C = 5\text{ mA}; V_{CE} = 10\text{ V}; f = 1\text{ kHz}$

h_{fe} > 45

$I_C = 50\text{ mA}; V_{CE} = 10\text{ V}; f = 20\text{ MHz}$

h_{fe} > 2.5

Collector capacitance

$I_E = I_e = 0; V_{CB} = 10\text{ V}$

C_c $< 15\text{ pF}$

Emitter capacitance

$I_C = I_c = 0; V_{EB} = 0.5\text{ V}$

C_e $< 85\text{ pF}$

SILICON PLANAR EPITAXIAL TRANSISTOR

N-P-N transistor in a TO-39 metal envelope with the collector connected to the case. It is primarily intended for use in high frequency and very high frequency oscillators and amplifiers as well as for output stages of servo amplifiers.

RATINGS (Limiting values)

Voltages

| | | | |
|---------------------------------------|-----------|------|------|
| Collector-base voltage (open emitter) | V_{CBO} | max. | 80 V |
| Collector-emitter voltage (open base) | V_{CEO} | max. | 35 V |
| Emitter-base voltage (open collector) | V_{EBO} | max. | 7 V |

Current

| | | | |
|--|-------|------|-----|
| Collector current (d.c. or average over any 20 ms period) | I_C | max. | 1 A |
|--|-------|------|-----|

Power dissipation

| | | | |
|--|-----------|------|-------|
| Total power dissipation up to $T_{amb} = 25\text{ }^\circ\text{C}$ | P_{tot} | max. | 0.8 W |
| up to $T_{case} = 100\text{ }^\circ\text{C}$ | P_{tot} | max. | 2.8 W |
| up to $T_{case} = 25\text{ }^\circ\text{C}$ | P_{tot} | max. | 5.0 W |

Temperatures

| | | | |
|----------------------|-----------|-------------|----------------------|
| Storage temperature | T_{stg} | -65 to +200 | $^\circ\text{C}$ |
| Junction temperature | T_j | max. | 200 $^\circ\text{C}$ |

THERMAL RESISTANCE

| | | | |
|--------------------------------------|---------------|---|----------------------------------|
| From junction to ambient in free air | $R_{th\ j-a}$ | = | 0.22 $^\circ\text{C}/\text{mW}$ |
| From junction to case | $R_{th\ j-c}$ | = | 0.035 $^\circ\text{C}/\text{mW}$ |

MECHANICAL DATA

Collector connected
to case
TO-39

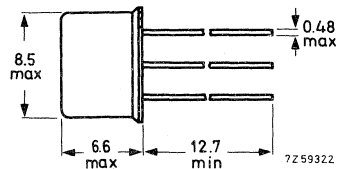
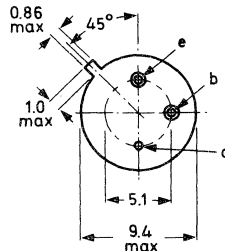

Dimensions in mm

max. lead diameter is guaranteed only for 12.7 mm

Accessories available: 56218, 56245.

$T_{amb} = 25\text{ }^{\circ}\text{C}$ unless otherwise specified

CHARACTERISTICS

Collector cut-off current

| | | | |
|--|-----------|---|------------------|
| $I_E = 0; V_{CB} = 60\text{ V}$ | I_{CBO} | < | 10 nA |
| $I_E = 0; V_{CB} = 60\text{ V}; T_{amb} = 150\text{ }^{\circ}\text{C}$ | I_{CBO} | < | 10 μA |

Emitter cut-off current

| | | | |
|--------------------------------|-----------|---|-------|
| $I_C = 0; V_{EB} = 5\text{ V}$ | I_{EBO} | < | 10 nA |
|--------------------------------|-----------|---|-------|

Sustaining voltage

| | | | |
|--|---------------|---|------|
| $I_C = 30\text{ mA}; I_B = 0\text{ }^2)$ | $V_{CEOsust}$ | > | 35 V |
|--|---------------|---|------|

Saturation voltages

| | | | |
|--|-------------|---|-------|
| $I_C = 150\text{ mA}; I_B = 15\text{ mA}$ | V_{CEsat} | < | 0.2 V |
| $I_C = 1\text{ A}; I_B = 100\text{ mA }^1)^2)$ | V_{CEsat} | < | 1.0 V |
| | V_{BEsat} | < | 1.6 V |

D.C. current gain ²⁾

| | | | |
|---|----------|-------|-----|
| $I_C = 10\text{ mA}; V_{CE} = 10\text{ V}$ | h_{FE} | > | 30 |
| $I_C = 150\text{ mA}; V_{CE} = 10\text{ V}$ | h_{FE} | 40 to | 120 |
| $I_C = 1\text{ A}; V_{CE} = 10\text{ V}$ | h_{FE} | > | 15 |

Feedback time constant

| | | | |
|--|-----------|---|--------|
| $I_C = 10\text{ mA}; V_{CB} = 10\text{ V}; f = 4\text{ MHz}$ | $r_b'C_C$ | < | 800 ps |
|--|-----------|---|--------|

Collector capacitance at $f = 500\text{ kHz}$

| | | | |
|---------------------------------------|-------|---|-------|
| $I_E = I_e = 0; V_{CB} = 10\text{ V}$ | C_C | < | 12 pF |
|---------------------------------------|-------|---|-------|

Emitter capacitance at $f = 500\text{ kHz}$

| | | | |
|--|-------|---|-------|
| $I_C = I_c = 0; V_{EB} = 0.5\text{ V}$ | C_e | < | 80 pF |
|--|-------|---|-------|

Transition frequency

| | | | |
|--|-------|---|--------|
| $I_C = 50\text{ mA}; V_{CE} = 10\text{ V}$ | f_T | > | 60 MHz |
|--|-------|---|--------|

1) Measured with a lead length of 1 cm.

2) Measured under pulsed conditions to avoid excessive dissipation.
Pulse duration $t = 300\text{ }\mu\text{s}$; duty cycle $\delta < 0.01$

SILICON PLANAR TRANSISTORS

N-P-N transistors in a TO-18 metal envelope with the collector connected to the case.

These transistors are primarily intended for use in high performance, low level, low noise amplifier applications both for d.c. and frequencies up to 100 MHz.

| QUICK REFERENCE DATA | | | |
|---|----------------|-----------|------------------------|
| | | 2N2483 | 2N2484 |
| Collector-base voltage (open emitter) | V_{CBO} max. | 60 | 60 V |
| Collector-emitter voltage (open base) | V_{CEO} max. | 60 | 60 V |
| Collector current (peak value) | I_{CM} max. | 50 | 50 mA |
| Total power dissipation up to $T_{amb} = 25\text{ }^{\circ}\text{C}$ | P_{tot} max. | 360 | 360 mW |
| Junction temperature | T_j max. | 200 | 200 $^{\circ}\text{C}$ |
| D.C. current gain at $T_j = 25\text{ }^{\circ}\text{C}$ | | | |
| $I_C = 10\text{ }\mu\text{A}; V_{CE} = 5\text{ V}$ | h_{FE} | 40 to 120 | 100 to 500 |
| $I_C = 1\text{ mA}; V_{CE} = 5\text{ V}$ | h_{FE} | > 175 | 250 |
| $I_C = 10\text{ mA}; V_{CE} = 5\text{ V}$ | h_{FE} | < 500 | 800 |
| Transition frequency | | | |
| $I_C = 0.5\text{ mA}; V_{CE} = 5\text{ V}$ | f_T typ. | 80 | 80 MHz |
| Noise figure | | | |
| $I_C = 10\text{ }\mu\text{A}; V_{CE} = 5\text{ V}; R_S = 10\text{ k}\Omega$ | | | |
| Bandwidth: 15.7 kHz | F | < 4 | 3 dB |

MECHANICAL DATA

Dimensions in mm

Collector connected
to case
TO-18

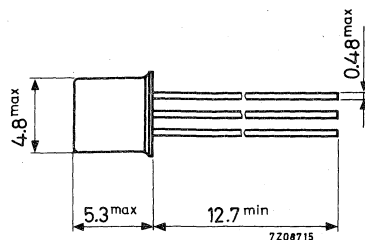
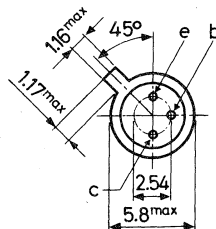

Accessories available: 56246, 56263

RATINGS (Limiting values) ¹⁾

Voltages

| | | | |
|---------------------------------------|-----------|------|------|
| Collector-base voltage (open emitter) | V_{CBO} | max. | 60 V |
| Collector-emitter voltage (open base) | V_{CEO} | max. | 60 V |
| Emitter-base voltage (open collector) | V_{EBO} | max. | 6 V |

Currents

| | | | |
|--------------------------------|----------|------|-------|
| Collector current (peak value) | I_{CM} | max. | 50 mA |
|--------------------------------|----------|------|-------|

Power dissipation

| | | | |
|---|-----------|------|--------|
| Total power dissipation up to $T_{amb} = 25^{\circ}C$ | P_{tot} | max. | 360 mW |
|---|-----------|------|--------|

Temperatures

| | | | |
|----------------------|-----------|-------------|-----------------|
| Storage temperature | T_{stg} | -65 to +200 | $^{\circ}C$ |
| Junction temperature | T_j | max. | 200 $^{\circ}C$ |

THERMAL RESISTANCE

| | | | |
|--------------------------------------|--------------|---|---------------------|
| From junction to ambient in free air | $R_{th j-a}$ | = | 0.48 $^{\circ}C/mW$ |
| From junction to case | $R_{th j-c}$ | = | 0.15 $^{\circ}C/mW$ |

¹⁾ Limiting values according to the Absolute Maximum System as defined in IEC publication 134.

CHARACTERISTICS

$T_j = 25\text{ }^\circ\text{C}$ unless otherwise specified

Collector cut-off current

| | | |
|--|-------------|------------------|
| $I_E = 0; V_{CB} = 45\text{ V}$ | $I_{CBO} <$ | 10 nA |
| $I_E = 0; V_{CB} = 45\text{ V}; T_j = 150\text{ }^\circ\text{C}$ | $I_{CBO} <$ | 10 μA |

Emitter cut-off current

| | | |
|--------------------------------|-------------|-------|
| $I_C = 0; V_{EB} = 5\text{ V}$ | $I_{EBO} <$ | 10 nA |
|--------------------------------|-------------|-------|

Base-emitter voltage

| | | |
|--|----------|--------------|
| $I_C = 0.1\text{ mA}; V_{CE} = 5\text{ V}$ | V_{BE} | 0.5 to 0.7 V |
|--|----------|--------------|

Collector-emitter saturation voltage

| | | |
|--|---------------|--------|
| $I_C = 1\text{ mA}; I_B = 0.1\text{ mA}$ | $V_{CEsat} <$ | 350 mV |
|--|---------------|--------|

D.C. current gain

| | 2N2483 | 2N2484 |
|--|---------------------------|------------|
| $I_C = 1\text{ }\mu\text{A}; V_{CE} = 5\text{ V}$ | $h_{FE} >$ | 30 |
| $I_C = 10\text{ }\mu\text{A}; V_{CE} = 5\text{ V}$ | $h_{FE} 40\text{ to }120$ | 100 to 500 |
| $I_C = 10\text{ }\mu\text{A}; V_{CE} = 5\text{ V}; T_j = 55\text{ }^\circ\text{C}$ | $h_{FE} > 10$ | 20 |
| $I_C = 100\text{ }\mu\text{A}; V_{CE} = 5\text{ V}$ | $h_{FE} > 75$ | 175 |
| $I_C = 500\text{ }\mu\text{A}; V_{CE} = 5\text{ V}$ | $h_{FE} > 100$ | 200 |
| $I_C = 1\text{ mA}; V_{CE} = 5\text{ V}$ | $h_{FE} > 175$ | 250 |
| $I_C = 10\text{ mA}; V_{CE} = 5\text{ V}^1$ | $h_{FE} < 500$ | 800 |

Collector capacitance at $f = 1\text{ MHz}$

| | | | |
|--------------------------------------|---------|---|------|
| $I_E = I_e = 0; V_{CB} = 5\text{ V}$ | $C_c <$ | 6 | 6 pF |
|--------------------------------------|---------|---|------|

Emitter capacitance at $f = 1\text{ MHz}$

| | | | |
|--|---------|---|------|
| $I_C = I_c = 0; V_{EB} = 0.5\text{ V}$ | $C_e <$ | 6 | 6 pF |
|--|---------|---|------|

Transition frequency

| | | | |
|---|---------|----|--------|
| $I_C = 50\text{ }\mu\text{A}; V_{CE} = 5\text{ V}$ | $f_T >$ | 12 | 15 MHz |
| $I_C = 500\text{ }\mu\text{A}; V_{CE} = 5\text{ V}$ | $f_T >$ | 60 | 60 MHz |
| | typ. | 80 | 80 MHz |

¹) Measured under pulsed conditions to prevent excessive dissipation.
Pulse duration $t < 300\text{ }\mu\text{s}$; duty cycle $\delta < 0.01$

CHARACTERISTICS (continued)

$T_j = 25\text{ }^\circ\text{C}$ unless otherwise specified

Noise figure

$I_C = 10\text{ }\mu\text{A}$; $V_{CE} = 5\text{ V}$; $R_S = 10\text{ k}\Omega$

$f = 100\text{ Hz}$; bandwidth 20 Hz

$f = 1\text{ kHz}$; bandwidth 200 Hz

$f = 10\text{ kHz}$; bandwidth 2 kHz

Wide band: bandwidth 15.7 kHz

| | 2N2483 | 2N2484 |
|-----|--------|--------|
| F < | 15 | 10 dB |
| F < | 4 | 3 dB |
| F < | 3 | 2 dB |
| F < | 4 | 3 dB |

h parameters at $f = 1\text{ kHz}$

$I_C = 1\text{ mA}$; $V_{CE} = 5\text{ V}$

Input impedance

Reverse voltage transfer

Small signal current gain

Output admittance

| | | |
|----------|-----------|----------------------------|
| h_{ie} | 1.5 to 13 | 3.5 to 24 $\text{k}\Omega$ |
| h_{re} | < 8 | 8 10^{-4} |
| h_{fe} | 80 to 450 | 150 to 900 |
| h_{oe} | < 30 | 40 $\mu\Omega^{-1}$ |



HIGH FREQUENCY PACKAGE

The high frequency package 40820 contains three silicon transistors selected from the BF194 and BF195 products.

The BF194B is intended for use as mixer-oscillator transistor, the BF195C for controlled first i.f. transistor, the BF195D for second i.f. transistor.

The low h_{FE} spread of the transistors makes it possible to apply current biasing (one base resistor) and achieve a gain with small spread and low dependence on supply voltage, even at low battery voltages.

The transistors have a plastic envelope with stiff, self-locking pins suitable for use with standard printed wiring-boards.

QUICK REFERENCE DATA

Base current

$I_C = 1 \text{ mA}; V_{CE} = 10 \text{ V}$

| | | |
|--------|-------|------------------------|
| BF194B | I_B | 5 to 9 μA |
| BF195C | I_B | 9 to 14 μA |
| BF195D | I_B | 14 to 26 μA |

Conversion noise figure of mixer BF194B

$I_C = 1 \text{ mA}; V_{CE} = 10 \text{ V}$

$G_S = 1.0 \text{ m}\Omega^{-1}; f = 1 \text{ MHz}$

F_c typ. 2 dB

APPLICATION INFORMATION

H.F. section of a 6 V medium wave portable radio receiver

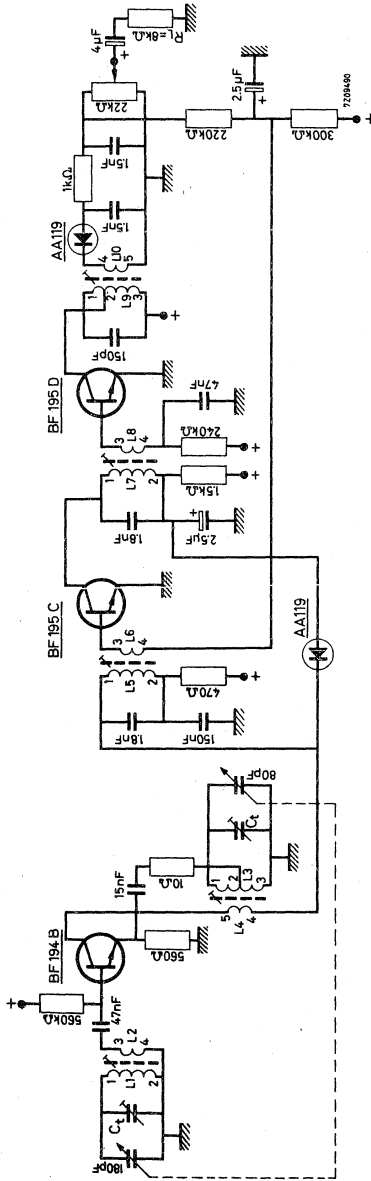

COIL DATA

| | |
|--|---|
| L1 = 450 μH; Q ₀ at f = 1 MHz : 120 | L5 = L7 = 69 μH; Q ₀ at f = 0.45 MHz : 80 |
| Voltage ratio $\frac{n3-4}{n1-2}$: 5.7x10 ⁻² | Voltage ratio $\frac{n3-4}{n1-2}$: 7.35x10 ⁻² |
| L3 = 260 μH; Q ₀ at f = 1.2 MHz : 120 | L9 = 800 μH; Q ₀ at f = 0.45 MHz : 110 |
| Voltage ratio $\frac{n2-3}{n1-3}$: 3x10 ⁻² | Voltage ratio $\frac{n2-3}{n1-3}$: 41.5x10 ⁻² |
| Voltage ratio $\frac{n4-5}{n1-3}$: 5.4x10 ⁻² | Voltage ratio $\frac{n4-5}{n1-3}$: 59.2x10 ⁻² |

PERFORMANCE at $f = 1 \text{ MHz}$; $T_{\text{amb}} = 25 \text{ }^\circ\text{C}$

Supply voltage (from 6 V, via a RC-smoothing filter)

$V_S = 5.25 \text{ V}$

Sensitivity

Signal to obtain $V_o = 10 \text{ mV}$ across $R_L = 8 \text{ k}\Omega$

$25 \text{ } \mu\text{V/m}$

Total current drain

$I_{\text{tot}} = 3 \text{ mA}$

Gain spread of the h.f. part

$\Delta G = \pm 3.6 \text{ dB}$

Signal to obtain 26 dB signal/noise ratio

$500 \text{ } \mu\text{V/m}$

Signal handling capability

$\geq 2 \text{ V/m}$

Decrease of sensitivity at $V_S \approx 3.2 \text{ V}$

15 dB

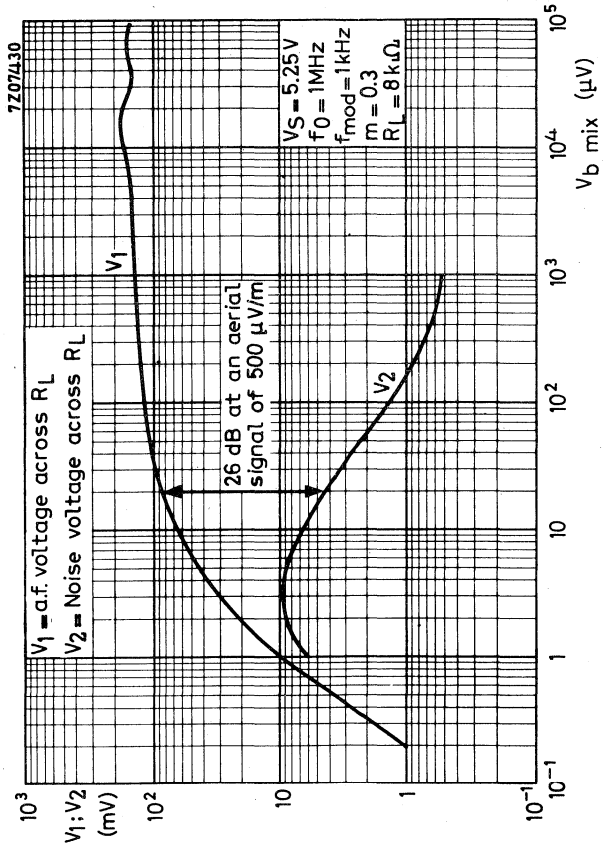

CHARACTERISTICS

$T_j = 25\text{ }^\circ\text{C}$ unless otherwise specified

Base current

$I_C = 1\text{ mA}; V_{CE} = 10\text{ V}$

| | | | |
|---------------|-------|----------|---------------|
| <u>BF194B</u> | I_B | 5 to 9 | μA |
| <u>BF195C</u> | I_B | 9 to 14 | μA |
| <u>BF195D</u> | I_B | 14 to 26 | μA |

Conversion noise figure of mixer BF194B

$I_C = 1\text{ mA}; V_{CE} = 10\text{ V}$

$G_S = 1.0\text{ m}\Omega^{-1}; f = 1\text{ MHz}$

F_C typ. 2 dB

y parameters (common emitter)

$I_C = 1\text{ mA}; V_{CE} = 10\text{ V}$ (lead length = 3 mm)

| | | $f = 10.7\text{ MHz}$ | | $f = 0.45\text{ MHz}$ | |
|--------------------|----------------|-----------------------|----------|-----------------------|-----------------------|
| Input conductance | <u>BF194B:</u> | g_{ie} | < 0.5 | 0.4 | $\text{m}\Omega^{-1}$ |
| | <u>BF195C:</u> | g_{ie} | < 0.64 | 0.54 | $\text{m}\Omega^{-1}$ |
| | <u>BF195D:</u> | g_{ie} | < 0.95 | 0.85 | $\text{m}\Omega^{-1}$ |
| Output conductance | <u>BF194B:</u> | g_{oe} | typ. 10 | 6.5 | $\mu\Omega^{-1}$ |
| | | | < 13.5 | 11.5 | $\mu\Omega^{-1}$ |
| | <u>BF195C:</u> | g_{oe} | typ. 6.5 | 4 | $\mu\Omega^{-1}$ |
| | | | < 9.5 | 7 | $\mu\Omega^{-1}$ |
| | <u>BF195D:</u> | g_{oe} | typ. 4 | 2 | $\mu\Omega^{-1}$ |
| | | | < 9.5 | 7 | $\mu\Omega^{-1}$ |

FOR THE REMAINING DATA OF THE INDIVIDUAL TRANSISTORS PLEASE REFER TO THE DATA SHEETS OF THE BF194 AND THE BF195

HIGH FREQUENCY PACKAGE

The high frequency package 40835 contains three silicon transistors selected from the BF494 and BF495 products.

The BF494B is intended for use as mixer-oscillator transistor,
the BF495C for controlled first i. f. transistor,
the BF495D for second i. f. transistor.

The low h_{FE} spread of the transistors makes it possible to apply current biasing (one base resistor) and achieve a gain with small spread and low dependence on supply voltage, even at low battery voltages.

QUICK REFERENCE DATA

Base current

$$I_C = 1 \text{ mA}; V_{CE} = 10 \text{ V}$$

BF494B I_B 5 to 9 μA

BF495C I_B 9 to 14 μA

BF495D I_B 14 to 26 μA

Conversion noise figure of mixer BF494B

$$I_C = 1 \text{ mA}; V_{CE} = 10 \text{ V}$$

$$G_S = 1 \text{ mA/V}; f = 1 \text{ MHz}$$

F_c typ. 2 dB

CHARACTERISTICS

 $T_j = 25\text{ }^\circ\text{C}$ unless otherwise specified

Base current

$I_C = 1\text{ mA}; V_{CE} = 10\text{ V}$

| | | | |
|---------------|-------|----------|---------------|
| <u>BF494B</u> | I_B | 5 to 9 | μA |
| <u>BF495C</u> | I_B | 9 to 14 | μA |
| <u>BF495D</u> | I_B | 14 to 26 | μA |

Conversion noise figure of mixer BF494B

$I_C = 1\text{ mA}; V_{CE} = 10\text{ V}$

$G_S = 1\text{ mA/V}; f = 1\text{ MHz}$

F_C typ. 2 dB

y parameters (common emitter)

$I_C = 1\text{ mA}; V_{CE} = 10\text{ V}$ (lead length = 3 mm)

| | | $f = 10,7\text{ MHz}$ | $f = 0,45\text{ MHz}$ |
|--------------------|----------------|-----------------------|-----------------------|
| Input conductance | <u>BF494B:</u> | $g_{ie} < 0,5$ | 0,4 mA/V |
| | <u>BF495C:</u> | $g_{ie} < 0,64$ | 0,54 mA/V |
| | <u>BF495D:</u> | $g_{ie} < 0,95$ | 0,85 mA/V |
| Output conductance | <u>BF494B:</u> | g_{oe} typ. 10 | 6,5 $\mu\text{A/V}$ |
| | | $g_{oe} < 13,5$ | 11,5 $\mu\text{A/V}$ |
| | <u>BF495C:</u> | g_{oe} typ. 6,5 | 4 $\mu\text{A/V}$ |
| | | $g_{oe} < 9,5$ | 7 $\mu\text{A/V}$ |
| | <u>BF495D:</u> | g_{oe} typ. 4 | 2 $\mu\text{A/V}$ |
| | | $g_{oe} < 9,5$ | 7 $\mu\text{A/V}$ |

FOR THE REMAINING DATA OF THE INDIVIDUAL TRANSISTORS PLEASE
REFER TO THE DATA SHEETS OF THE BF494 AND THE BF495

FOR APPLICATION INFORMATION SEE 40820

in which BF194B must be replaced by BF494B,
BF195C by BF495C,
BF195D by BF495D.

HIGH-FREQUENCY PACKAGE

The high-frequency package 40838 contains three transistors selected from the BF240 and BF241 products.

The BF240B is intended for use as mixer-oscillator transistor, the BF241C for controlled first i. f. transistor, the BF241D for second i. f. transistor.

The low h_{FE} spread of the transistors makes it possible to apply current biasing (one base resistor) and achieve a gain with small spread and low dependence on supply voltage, even at low battery voltages.

QUICK REFERENCE DATA

| | | | |
|---|--------|-------|------------------------|
| Base current | | | |
| $I_C = 1 \text{ mA}; V_{CE} = 10 \text{ V}$ | BF240B | I_B | 5 to 9 μA |
| | BF241C | I_B | 9 to 14 μA |
| | BF241D | I_B | 14 to 26 μA |
| Conversion noise figure of mixer BF240B | | | |
| $I_C = 1 \text{ mA}; V_{CE} = 10 \text{ V}$ | | F_c | typ. 2 dB |
| $G_S = 1 \text{ mA/V}; f = 1 \text{ MHz}$ | | | |

CHARACTERISTICS

$T_j = 25\text{ }^\circ\text{C}$ unless otherwise specified

Base current

$I_C = 1\text{ mA}; V_{CE} = 10\text{ V}$

| | | | |
|--------|-------|----------|---------------|
| BF240B | I_B | 5 to 9 | μA |
| BF241C | I_B | 9 to 14 | μA |
| BF241D | I_B | 14 to 26 | μA |

Conversion noise figure of mixer BF240B

$I_C = 1\text{ mA}; V_{CE} = 10\text{ V}$
 $G_s = 1\text{ mA/V}; f = 1\text{ MHz}$

F_c typ. 2 dB

y parameters (common emitter)

$I_C = 1\text{ mA}; V_{CE} = 10\text{ V}$ (lead length = 3 mm)

| | | | | $f = 10, 7$ | | $0, 45$ MHz | |
|--------------------|-----------------|----------|------|-------------|-----|-----------------|--|
| Input conductance | <u>BF240B</u> : | g_{ie} | typ. | 0,3 | 0,2 | mA/V | |
| | <u>BF241C</u> : | g_{ie} | typ. | 0,5 | 0,4 | mA/V | |
| | <u>BF241D</u> : | g_{ie} | typ. | 0,7 | 0,6 | mA/V | |
| Output conductance | <u>BF240B</u> : | g_{oe} | typ. | 7 | 5 | $\mu\text{A/V}$ | |
| | | | < | 10 | 8 | $\mu\text{A/V}$ | |
| | <u>BF241C</u> : | g_{oe} | typ. | 5 | 3 | $\mu\text{A/V}$ | |
| | | | < | 7 | 5 | $\mu\text{A/V}$ | |
| | <u>BF241D</u> : | g_{oe} | typ. | 5 | 3 | $\mu\text{A/V}$ | |
| | | | < | 6 | 4 | $\mu\text{A/V}$ | |

FOR THE REMAINING DATA OF THE INDIVIDUAL TRANSISTORS PLEASE REFER TO THE DATA SHEETS OF THE BF240 AND THE BF241

FOR APPLICATION INFORMATION SEE 40820

in which BF194B must be replaced by BF240B,
 BF195C by BF241C,
 BF195D by BF241D.

Switching transistors



GERMANIUM ALLOYED TRANSISTORS

P-N-P transistors in a TO-5 metal envelope with the base connected to the case. These general purpose transistors are primarily intended for medium current medium speed computer logic applications.

RATINGS Limiting values according to the Absolute Maximum System as defined in IEC publication 134.

| <u>Voltages</u> | | ASY26 | ASY27 |
|---|------------|---------|-------|
| Collector-base voltage (open emitter) | $-V_{CB0}$ | max. 30 | 25 V |
| Collector-emitter voltage (open base) | $-V_{CEO}$ | max. 15 | 15 V |
| Collector-emitter voltage at $+V_{BE} = 0.2V$ | $-V_{CEX}$ | max. 25 | 20 V |
| Emitter-base voltage (open collector) | $-V_{EBO}$ | max. 20 | 20 V |

Currents

| | | | |
|---|-----------|------|--------|
| Collector current (d.c. or average over any 20 ms period) | $-I_C$ | max. | 200 mA |
| Collector current (peak value) | $-I_{CM}$ | max. | 300 mA |

Power dissipation

| | | | |
|--|-----------|------|--------|
| Total power dissipation up to $T_{amb} = 25^\circ C$ | P_{tot} | max. | 150 mW |
|--|-----------|------|--------|

Temperatures

| | | | |
|----------------------|-----------|-------------|---------------|
| Storage temperature | T_{stg} | -65 to +100 | $^\circ C$ |
| Junction temperature | T_j | max. | 85 $^\circ C$ |

MECHANICAL DATA

Dimensions in mm

TO-5

Base connected to case

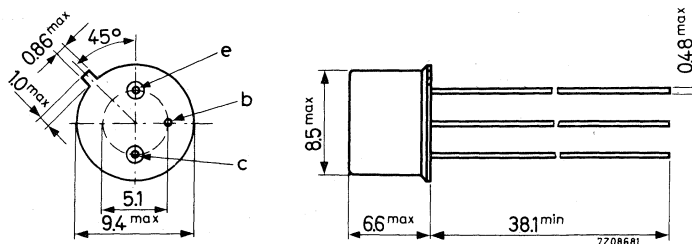

Accessories available: 56218, 56245.

THERMAL RESISTANCE

| | | | |
|--------------------------------------|---------------|---|-----------|
| From junction to ambient in free air | $R_{th\ j-a}$ | = | 0.4 °C/mW |
| From junction to case | $R_{th\ j-c}$ | = | 0.2 °C/mW |

CHARACTERISTICS $T_j = 25\ ^\circ\text{C}$ unless otherwise specified

| | | ASY26 | ASY27 |
|---|----------------|------------------|------------------|
| <u>Collector cut-off current</u> | | | |
| $I_E = 0; -V_{CB} = 30\ \text{V}$ | $-I_{CBO}$ | < 7 | μA |
| $I_E = 0; -V_{CB} = 25\ \text{V}$ | $-I_{CBO}$ | < | 7 μA |
| $I_E = 0; -V_{CB} = 30\ \text{V}; T_j = 60\ ^\circ\text{C}$ | $-I_{CBO}$ | < 35 | μA |
| $I_E = 0; -V_{CB} = 25\ \text{V}; T_j = 60\ ^\circ\text{C}$ | $-I_{CBO}$ | < | 35 μA |
| <u>Emitter cut-off current</u> | | | |
| $I_C = 0; -V_{EB} = 5\ \text{V}$ | $-I_{EBO}$ | < 3 | 3 μA |
| <u>Currents at reverse biased emitter junction</u> | | | |
| $-V_{CE} = 25\ \text{V}; +V_{BE} = 0.2\ \text{V}; T_j = 60\ ^\circ\text{C}$ | $-I_{CEX}$ | < 35 | μA |
| $-V_{CE} = 20\ \text{V}; +V_{BE} = 0.2\ \text{V}; T_j = 60\ ^\circ\text{C}$ | $-I_{CEX}$ | < | 35 μA |
| $-V_{CE} = 20\ \text{V}; +V_{BE} = 5\ \text{V}; T_j = 60\ ^\circ\text{C}$ | $+I_{BEX}$ | < 35 | 35 μA |
| <u>Base-emitter voltage</u> | | | |
| $-I_C = 100\ \text{mA}; -V_{CE} = 1\ \text{V}$ | $-V_{BE}$ | < 0.65 | 0.55 V |
| $-I_C = 300\ \text{mA}; -V_{CE} = 1\ \text{V}$ | $-V_{BE}$ | < 1.5 | 1.4 V |
| <u>Collector-emitter saturation voltage</u> | | | |
| $-I_C = 10\ \text{mA}; -I_B = 0.33\ \text{mA}$ | $-V_{CE\ sat}$ | < 0.20 | V |
| $-I_C = 10\ \text{mA}; -I_B = 0.2\ \text{mA}$ | $-V_{CE\ sat}$ | < | 0.20 V |
| $-I_C = 50\ \text{mA}; -I_B = 2\ \text{mA}$ | $-V_{CE\ sat}$ | < 0.25 | V |
| $-I_C = 50\ \text{mA}; -I_B = 1.25\ \text{mA}$ | $-V_{CE\ sat}$ | < | 0.25 V |
| <u>Base-emitter saturation voltage</u> | | | |
| $-I_C = 10\ \text{mA}; -I_B = 0.4\ \text{mA}$ | $-V_{BE\ sat}$ | > 0.20 < 0.37 | V V |
| $-I_C = 10\ \text{mA}; -I_B = 0.25\ \text{mA}$ | $-V_{BE\ sat}$ | > < | 0.15 V 0.32 V |
| $-I_C = 50\ \text{mA}; -I_B = 2.4\ \text{mA}$ | $-V_{BE\ sat}$ | < 0.55 | V |
| $-I_C = 50\ \text{mA}; -I_B = 1.55\ \text{mA}$ | $-V_{BE\ sat}$ | < | 0.45 V |

CHARACTERISTICS (continued) $T_j = 25\text{ }^\circ\text{C}$ unless otherwise specified

| | | ASY26 | ASY27 |
|--|--------------------------------|----------|------------------------------|
| <u>Collector-emitter sustaining voltage</u> | | | |
| $-I_C = 5\text{ mA}; I_B = 0$ | $-V_{CEO\text{ sust}}$ | > 15 | 15 V |
| <u>Punch through voltage</u> | | | |
| | V_{pt} | > 25 | 20 V |
| <u>Base-emitter floating voltage</u> | | | |
| $I_B = 0; -V_{CE} = 25\text{ V}; T_j = 60\text{ }^\circ\text{C}$ | $-V_{BE\text{ fl}}$ | < 0.20 | V |
| $I_B = 0; -V_{CE} = 20\text{ V}; T_j = 60\text{ }^\circ\text{C}$ | $-V_{BE\text{ fl}}$ | < | 0.20 V |
| <u>D.C. current gain</u> | | | |
| $-I_C = 10\text{ mA}; -V_{CE} = 1\text{ V}$ | h_{FE} | > 30 | 50 |
| | | typ. 45 | 80 |
| $-I_C = 20\text{ mA}; -V_{CE} = 1\text{ V}$ | h_{FE} | > 30 | 50 |
| | | typ. 47 | 78 |
| | | < 80 | 150 |
| $-I_C = 100\text{ mA}; -V_{CE} = 1\text{ V}$ | h_{FE} | > 20 | 30 |
| | | typ. 39 | 58 |
| $-I_C = 200\text{ mA}; -V_{CE} = 1\text{ V}$ | h_{FE} | > 15 | 20 |
| | | typ. 27 | 40 |
| <u>Collector capacitance at $f = 1\text{ MHz}$</u> | | | |
| $I_E = I_e = 0; -V_{CB} = 5\text{ V}$ | C_c | typ. 11 | 11 pF |
| | | < 16 | 16 pF |
| <u>Emitter capacitance at $f = 1\text{ MHz}$</u> | | | |
| $I_C = I_c = 0; -V_{EB} = 5\text{ V}$ | C_e | typ. 7 | 6 pF |
| | | < 13 | 13 pF |
| <u>Transition frequency</u> | | | |
| $-I_C = 3\text{ mA}; -V_{CE} = 5\text{ V}$ | f_T | > 4 | 6 MHz |
| | | typ. 8 | 14 MHz |
| <u>h parameters at $f = 1\text{ kHz}$</u> | | | |
| $-I_C = 2\text{ mA}; -V_{CE} = 5\text{ V}$ | Input impedance | h_{ie} | typ. 0.75 1.4 k Ω |
| | Reverse voltage transfer ratio | h_{re} | typ. 5.0 7.5 10^{-4} |
| | Small signal current gain | h_{fe} | typ. 50 90 |
| | Output admittance | h_{oe} | typ. 65 100 $\mu\Omega^{-1}$ |

ASY26 ASY27

CHARACTERISTICS (continued) $T_j = 25^\circ\text{C}$

Switching characteristics

Desaturation time constant

$I_C = 0; -I_B = 1\text{ mA}$

| | ASY26 | ASY27 |
|----------|--------|--------------------|
| τ_s | < 1.25 | 1.25 μs |

Current feed time constant

$-I_{CM} = 50\text{ mA}; -V_{CE} = 0.75\text{ V}$

| | | |
|----------|-------|-------------------|
| τ_c | < 2.2 | 2.2 μs |
|----------|-------|-------------------|

Voltage feed time constant

$-I_{CM} = 1\text{ mA}; -V_{CE} = 0.75\text{ V}$

| | | |
|----------|-------|-------------------|
| τ_v | < 0.2 | 0.2 μs |
|----------|-------|-------------------|

Switching times (See test circuit)

delay time

| | | |
|-------|---------|-------|
| t_d | typ. 65 | 50 ns |
| | < 90 | 75 ns |

rise time

| | | |
|-------|----------|--------|
| t_r | typ. 275 | 200 ns |
| | < 490 | 350 ns |

storage time

| | | |
|-------|----------|---------|
| t_s | typ. 500 | 600 ns |
| | < 1350 | 1500 ns |

fall time

| | | |
|-------|----------|--------|
| t_f | typ. 475 | 400 ns |
| | < 730 | 620 ns |

Test circuit:

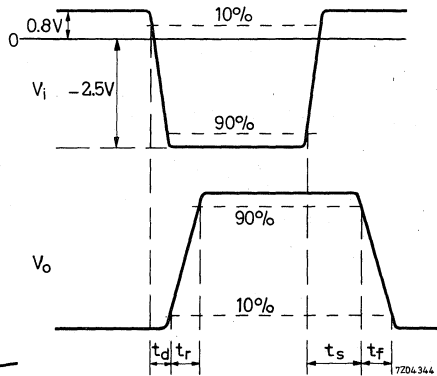
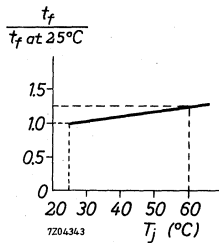
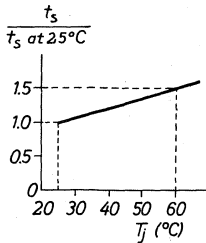
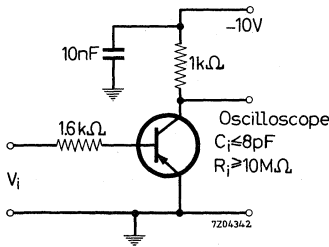

GERMANIUM ALLOYED TRANSISTORS

N-P-N transistors in a TO-5 metal envelope with the base connected to the case. These general purpose transistors are primarily intended for medium current medium speed computer logic applications.

RATINGS Limiting values according to the Absolute Maximum System as defined in IEC publication 134.

Voltages

| | | ASY28 | ASY29 |
|--|-----------|---------|-------|
| Collector-base voltage (open emitter) | V_{CBO} | max. 30 | 25 V |
| Collector-emitter voltage (open base) | V_{CEO} | max. 15 | 15 V |
| Collector-emitter voltage at $-V_{BE} = 0.2$ V | V_{CEX} | max. 25 | 20 V |
| Emitter-base voltage (open collector) | V_{EBO} | max. 20 | 20 V |

Currents

| | | | |
|---|----------|------|--------|
| Collector current (d.c. or average over any 20 ms period) | I_C | max. | 200 mA |
| Collector current (peak value) | I_{CM} | max. | 300 mA |

Power dissipation

| | | | |
|---|-----------|------|--------|
| Total power dissipation up to $T_{amb} = 25$ °C | P_{tot} | max. | 150 mW |
|---|-----------|------|--------|

Temperatures

| | | | |
|----------------------|-----------|-------------|-------|
| Storage temperature | T_{stg} | -65 to +100 | °C |
| Junction temperature | T_j | max. | 85 °C |

MECHANICAL DATA

Dimensions in mm

TO-5

Base connected to case

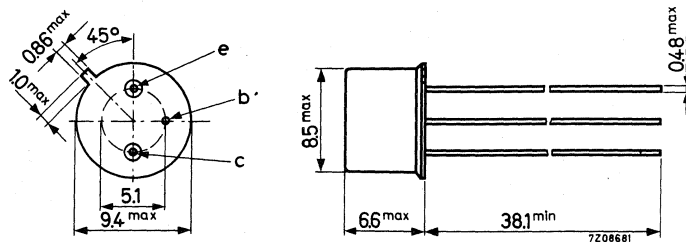

Accessories available: 56218, 56245.

THERMAL RESISTANCE

| | | | |
|--------------------------------------|---------------|---|-----------|
| From junction to ambient in free air | $R_{th\ j-a}$ | = | 0.4 °C/mW |
| From junction to case | $R_{th\ j-c}$ | = | 0.2 °C/mW |

CHARACTERISTICS $T_j = 25\ ^\circ\text{C}$ unless otherwise specified

| <u>Collector cut-off current</u> | | ASY28 | ASY29 |
|--|-----------------|-------|------------------|
| $I_E = 0; V_{CB'} = 30\ \text{V}$ | $I_{CBO} <$ | 7 | μA |
| $I_E = 0; V_{CB} = 25\ \text{V}$ | $I_{CBO} <$ | | 7 μA |
| $I_E = 0; V_{CB} = 30\ \text{V}; T_j = 60\ ^\circ\text{C}$ | $I_{CBO} <$ | 35 | μA |
| $I_E = 0; V_{CB} = 25\ \text{V}; T_j = 60\ ^\circ\text{C}$ | $I_{CBO} <$ | | 35 μA |
| <u>Emitter cut-off current</u> | | | |
| $I_C = 0; V_{EB} = 5\ \text{V}$ | $I_{EBO} <$ | 3 | 3 μA |
| <u>Currents at reverse biased emitter junction</u> | | | |
| $V_{CE} = 25\ \text{V}; -V_{BE} = 0.2\ \text{V}; T_j = 60\ ^\circ\text{C}$ | $I_{CEX} <$ | 35 | μA |
| $V_{CE} = 20\ \text{V}; -V_{BE} = 0.2\ \text{V}; T_j = 60\ ^\circ\text{C}$ | $I_{CEX} <$ | | 35 μA |
| $V_{CE} = 20\ \text{V}; -V_{BE} = 5\ \text{V}; T_j = 60\ ^\circ\text{C}$ | $-I_{BEX} <$ | 35 | 35 μA |
| <u>Base-emitter voltage</u> | | | |
| $I_C = 100\ \text{mA}; V_{CE} = 1\ \text{V}$ | $V_{BE} <$ | 0.65 | 0.55 V |
| $I_C = 300\ \text{mA}; V_{CE} = 1\ \text{V}$ | $V_{BE} <$ | 1.5 | 1.4 V |
| <u>Collector-emitter saturation voltage</u> | | | |
| $I_C = 10\ \text{mA}; I_B = 0.33\ \text{mA}$ | $V_{CE\ sat} <$ | 0.20 | V |
| $I_C = 10\ \text{mA}; I_B = 0.2\ \text{mA}$ | $V_{CE\ sat} <$ | | 0.20 V |
| $I_C = 50\ \text{mA}; I_B = 2\ \text{mA}$ | $V_{CE\ sat} <$ | 0.25 | V |
| $I_C = 50\ \text{mA}; I_B = 1.25\ \text{mA}$ | $V_{CE\ sat} <$ | | 0.25 V |
| <u>Base-emitter saturation voltage</u> | | | |
| $I_C = 10\ \text{mA}; I_B = 0.4\ \text{mA}$ | $V_{BE\ sat} >$ | 0.20 | V |
| | $V_{BE\ sat} <$ | 0.37 | V |
| $I_C = 10\ \text{mA}; I_B = 0.25\ \text{mA}$ | $V_{BE\ sat} >$ | | 0.15 V |
| | $V_{BE\ sat} <$ | | 0.32 V |
| $I_C = 50\ \text{mA}; I_B = 2.4\ \text{mA}$ | $V_{BE\ sat} <$ | 0.55 | V |
| $I_C = 50\ \text{mA}; I_B = 1.55\ \text{mA}$ | $V_{BE\ sat} <$ | | 0.45 V |

CHARACTERISTICS (continued) $T_j = 25\text{ }^\circ\text{C}$ unless otherwise specified

| | | ASY28 | ASY29 |
|---|-----------------------|-----------|----------------------|
| <u>Collector-emitter sustaining voltage</u> | | | |
| $I_C = 5\text{ mA}; I_B = 0$ | $V_{CE0\text{ sust}}$ | > 15 | 15 V |
| <u>Punch through voltage</u> | | | |
| | V_{pt} | > 25 | 20 V |
| <u>Base-emitter floating voltage</u> | | | |
| $I_B = 0; V_{CE} = 25\text{ V}; T_j = 60\text{ }^\circ\text{C}$ | $V_{BE\text{ fl}}$ | < 0.20 | V |
| $I_B = 0; V_{CE} = 20\text{ V}; T_j = 60\text{ }^\circ\text{C}$ | $V_{BE\text{ fl}}$ | < | 0.20 V |
| <u>D.C. current gain</u> | | | |
| $I_C = 10\text{ mA}; V_{CE} = 1\text{ V}$ | h_{FE} | > | 30 |
| | | typ. | 43 |
| $I_C = 20\text{ mA}; V_{CE} = 1\text{ V}$ | h_{FE} | > | 30 |
| | | typ. | 46 |
| | | < | 80 |
| $I_C = 100\text{ mA}; V_{CE} = 1\text{ V}$ | h_{FE} | > | 20 |
| | | typ. | 43 |
| $I_C = 200\text{ mA}; V_{CE} = 1\text{ V}$ | h_{FE} | > | 15 |
| | | typ. | 32 |
| <u>Collector capacitance at $f = 1\text{ MHz}$</u> | | | |
| $I_E = I_e = 0; V_{CB} = 5\text{ V}$ | C_c | typ. | 11 |
| | | < | 16 |
| <u>Emitter capacitance at $f = 1\text{ MHz}$</u> | | | |
| $I_C = I_c = 0; V_{EB} = 5\text{ V}$ | C_e | typ. | 7 |
| | | < | 13 |
| <u>Transition frequency</u> | | | |
| $I_C = 3\text{ mA}; V_{CE} = 5\text{ V}$ | f_T | > | 4 |
| | | typ. | 14 |
| <u>h parameters at $f = 1\text{ kHz}$</u> | | | |
| $I_C = 2\text{ mA}; V_{CE} = 5\text{ V}$ | | | |
| Input impedance | h_{ie} | typ. 0.75 | 1.4 $\text{k}\Omega$ |
| Reverse voltage transfer ratio | h_{re} | typ. 3.5 | 5.0 10^{-4} |
| Small signal current gain | h_{fe} | typ. 50 | 90 |
| Output admittance | h_{oe} | typ. 45 | 70 $\mu\Omega^{-1}$ |

ASY28 ASY29

CHARACTERISTICS (continued) $T_j = 25^\circ\text{C}$

Switching characteristics

Desaturation time constant

$$I_C = 0; I_B = 1 \text{ mA}$$

| | ASY28 | ASY29 |
|----------|-------|-------------------|
| τ_s | < 1.4 | 1.4 μs |

Current feed time constant

$$I_{CM} = 50 \text{ mA}; V_{CE} = 0.75 \text{ V}$$

| | | |
|----------|-------|-------------------|
| τ_c | < 2.2 | 2.2 μs |
|----------|-------|-------------------|

Voltage feed time constant

$$I_{CM} = 1 \text{ mA}; V_{CE} = 5 \text{ V}$$

| | | |
|----------|-------|-------------------|
| τ_v | < 0.2 | 0.2 μs |
|----------|-------|-------------------|

Switching times (See test circuit)

delay time

| | | |
|-------|---------|-------|
| t_d | typ. 50 | 45 ns |
| | < 90 | 75 ns |

rise time

| | | |
|-------|----------|--------|
| t_r | typ. 175 | 140 ns |
| | < 400 | 300 ns |

storage time

| | | |
|-------|----------|--------|
| t_s | typ. 450 | 500 ns |
| | < 700 | 800 ns |

fall time

| | | |
|-------|----------|--------|
| t_f | typ. 325 | 300 ns |
| | < 620 | 520 ns |

Test circuit:

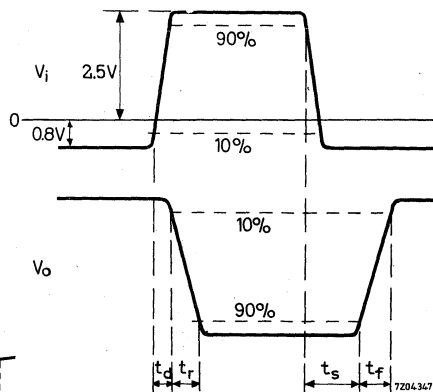
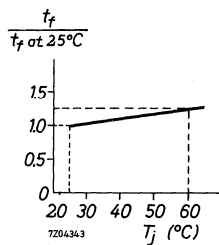
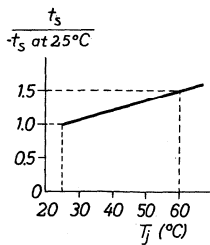
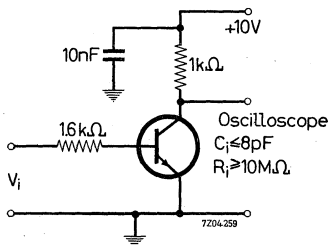

SYMMETRICAL N-P-N SWITCHING TRANSISTORS

Symmetrical N-P-N germanium alloy transistors in a TO-5 metal envelope with the base connected to the case intended for high current medium speed switching applications.

| QUICK REFERENCE DATA | | | | | |
|---|-----------|----------|-------|-------|------------------|
| | | ASY73 | ASY74 | ASY75 | |
| Collector-base voltage (open emitter) | V_{CB0} | max. 30 | 30 | 30 | V |
| Collector-emitter voltage (open base) | V_{CEO} | max. 15 | 15 | 15 | V |
| Collector-current (d.c. or average) | I_C | max. 400 | 400 | 400 | mA |
| Total power dissipation up to $T_{amb} = 25^\circ\text{C}$ | P_{tot} | max. 140 | 140 | 140 | mW |
| Junction temperature | T_j | max. 75 | 75 | 75 | $^\circ\text{C}$ |
| D.C. current gain at $T_j = 25^\circ\text{C}$ | | | | | |
| $-I_E = 200\text{ mA}; V_{CB} = 0$ | h_{FE} | > 20 | 35 | 50 | |
| $-I_C = 200\text{ mA}; V_{EB} = 0$ | h_{FC} | > 12 | 20 | 20 | |
| Transition frequency $-I_E = 3\text{ mA}; V_{CB} = 5\text{ V}$ | f_T | > 4 | 6 | 10 | MHz |
| Desaturation time constant $I_B = 1\text{ mA}; I_C = 0$ | τ_s | <1.75 | 1.75 | 1.75 | μs |

MECHANICAL DATA

Dimensions in mm

TO-5

Base connected to case

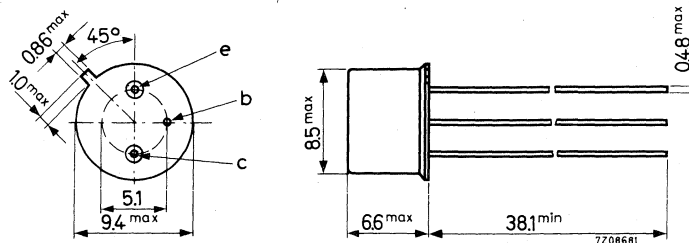

Accessories available: 56218, 56245

RATINGS (Limiting values) ¹⁾

Voltages

| | | | |
|--|-----------|------|--------------------|
| Collector-base voltage (open-emitter) | V_{CBO} | max. | 30 V |
| Collector-emitter voltage (open base) | V_{CEO} | max. | 15 V ²⁾ |
| Collector-emitter voltage with - $V_{BE} = 0.2$ V | V_{CEX} | max. | 20 V ²⁾ |
| Emitter-base voltage (open collector) | V_{EBO} | max. | 30 V |

Currents

| | | | |
|--|----------|------|--------|
| Collector current (d.c. or average over any 20 ms period) | I_C | max. | 400 mA |
| Emitter current (d.c. or average over any 20 ms period) | $-I_E$ | max. | 400 mA |
| Base current (d.c. or average over any 20 ms period) | I_B | max. | 40 mA |
| Base current (peak value) | I_{BM} | max. | 400 mA |

Power dissipation

| | | | |
|---|-----------|------|--------|
| Total steady state power dissipation up to $T_{amb} = 25$ °C | P_{tot} | max. | 140 mW |
|---|-----------|------|--------|

Temperatures

| | | |
|--------------------------------|-----------|--------------|
| Storage temperature | T_{stg} | -55 to 85 °C |
| Operating junction temperature | T_j | max. 75 °C |

THERMAL RESISTANCE

| | | | |
|--------------------------------------|--------------|---|------------|
| From junction to ambient in free air | $R_{th j-a}$ | = | 0.35 °C/mW |
| From junction to case | $R_{th j-c}$ | = | 0.2 °C/mW |

¹⁾ Limiting values according to the Absolute Maximum System as defined in IEC publication 134.

²⁾ For switch-off transients with inductive load see page 12

CHARACTERISTICS

$T_j = 25\text{ }^\circ\text{C}$ unless otherwise specified

Collector cut-off current

| | |
|--|------------------------------------|
| $I_E = 0; V_{CB} = 5\text{ V}$ | $I_{CBO} < 3\text{ }\mu\text{A}$ |
| $V_{CB} = 30\text{ V}; T_j = 55\text{ }^\circ\text{C}$ | $I_{CBO} < 100\text{ }\mu\text{A}$ |

Emitter cut-off current

| | |
|--|------------------------------------|
| $I_C = 0; V_{EB} = 5\text{ V}$ | $I_{EBO} < 3\text{ }\mu\text{A}$ |
| $V_{EB} = 30\text{ V}; T_j = 55\text{ }^\circ\text{C}$ | $I_{EBO} < 100\text{ }\mu\text{A}$ |

Currents at reverse biased emitter junction

| | |
|--|------------------------------------|
| $V_{CE} = 20\text{ V}; -V_{BE} = 0.2\text{ V}; T_j = 55\text{ }^\circ\text{C}$ | $I_{CEX} < 50\text{ }\mu\text{A}$ |
| $-V_{BE} = 20\text{ V}; V_{CB} = 20\text{ V}; T_j = 55\text{ }^\circ\text{C}$ | $-I_{BEX} < 50\text{ }\mu\text{A}$ |

Saturation voltages

| | |
|---|-----------------------------|
| <u>ASY73.</u> $I_C = 50\text{ mA}; I_B = 2.5\text{ mA}$ | $V_{CEsat} < 0.22\text{ V}$ |
| $I_C = 200\text{ mA}; I_B = 10\text{ mA}$ | $V_{CEsat} < 0.30\text{ V}$ |
| $I_E = 200\text{ mA}; I_B = 16.5\text{ mA}$ | $V_{ECsat} < 0.30\text{ V}$ |
| $I_C = 50\text{ mA}; I_B = 3\text{ mA}$ | $V_{BEsat} < 0.50\text{ V}$ |
| $I_C = 200\text{ mA}; I_B = 12\text{ mA}$ | $V_{BEsat} < 0.90\text{ V}$ |

| | |
|--|-----------------------------|
| <u>ASY74.</u> $I_C = 50\text{ mA}; I_B = 1.25\text{ mA}$ | $V_{CEsat} < 0.22\text{ V}$ |
| $I_C = 200\text{ mA}; I_B = 5.7\text{ mA}$ | $V_{CEsat} < 0.30\text{ V}$ |
| $I_C = 400\text{ mA}; I_B = 20\text{ mA}$ | $V_{CEsat} < 0.37\text{ V}$ |
| $I_E = 200\text{ mA}; I_B = 10\text{ mA}$ | $V_{ECsat} < 0.30\text{ V}$ |
| $I_C = 50\text{ mA}; I_B = 1.5\text{ mA}$ | $V_{BEsat} < 0.38\text{ V}$ |
| $I_C = 200\text{ mA}; I_B = 7\text{ mA}$ | $V_{BEsat} < 0.70\text{ V}$ |
| $I_C = 400\text{ mA}; V_{CB} = 0$ | $V_{BEsat} < 0.90\text{ V}$ |

| | |
|--|-----------------------------|
| <u>ASY75.</u> $I_C = 50\text{ mA}; I_B = 0.75\text{ mA}$ | $V_{CEsat} < 0.22\text{ V}$ |
| $I_C = 200\text{ mA}; I_B = 4\text{ mA}$ | $V_{CEsat} < 0.30\text{ V}$ |
| $I_C = 400\text{ mA}; I_B = 13.5\text{ mA}$ | $V_{CEsat} < 0.37\text{ V}$ |
| $I_E = 200\text{ mA}; I_B = 10\text{ mA}$ | $V_{ECsat} < 0.30\text{ V}$ |
| $I_C = 50\text{ mA}; I_B = 0.95\text{ mA}$ | $V_{BEsat} < 0.34\text{ V}$ |
| $I_C = 200\text{ mA}; I_B = 5\text{ mA}$ | $V_{BEsat} < 0.60\text{ V}$ |
| $I_C = 400\text{ mA}; V_{CB} = 0$ | $V_{BEsat} < 0.70\text{ V}$ |

Sustaining voltage

| | |
|-------------------------------|------------------------------------|
| $I_C = 10\text{ mA}; I_B = 0$ | $V_{CEO\text{sust}} > 15\text{ V}$ |
|-------------------------------|------------------------------------|

CHARACTERISTICS (continued)

$T_j = 25\text{ }^\circ\text{C}$ unless otherwise specified

Punch-through voltage

$$V_{pt} > 20\text{ V}$$

Floating potential

$$I_E = 0; V_{CB} = 20\text{ V}; T_j = 55\text{ }^\circ\text{C}$$

$$V_{EBfl} < 180\text{ mV}$$

$$I_C = 0; V_{CB} = 20\text{ V}; T_j = 55\text{ }^\circ\text{C}$$

$$V_{CBfl} < 180\text{ mV}$$

D.C. current gain

ASY73 $V_{CB} = 0; -I_E = 50\text{ mA}$
 $V_{CB} = 0; -I_E = 200\text{ mA}$
 $V_{EB} = 0; -I_C = 200\text{ mA}$

$$h_{FE} > 25$$

$$h_{FE} > 20$$

$$h_{FC} > 12$$

ASY74 $V_{CB} = 0; -I_E = 50\text{ mA}$
 $V_{CB} = 0; -I_E = 200\text{ mA}$
 $V_{CB} = 0; -I_E = 400\text{ mA}$
 $V_{EB} = 0; -I_C = 200\text{ mA}$

$$h_{FE} > 40$$

$$h_{FE} > 35$$

$$h_{FE} > 20$$

$$h_{FC} > 20$$

ASY75 $V_{CB} = 0; -I_E = 50\text{ mA}$
 $V_{CB} = 0; -I_E = 200\text{ mA}$
 $V_{CB} = 0; -I_E = 400\text{ mA}$
 $V_{EB} = 0; -I_C = 200\text{ mA}$

$$h_{FE} > 65$$

$$h_{FE} > 50$$

$$h_{FE} > 30$$

$$h_{FC} > 20$$

Switching parameters

$$\text{Desaturation time constant } I_B = 1\text{ mA}; I_C = 0$$

$$\tau_s < 1.75\text{ }\mu\text{s}$$

$$\text{Current-feed time constant } I_{CM} = 200\text{ mA};$$

$$V_{CE} = 0.75\text{ V}$$

$$\tau_c < 1.75\text{ }\mu\text{s}$$

$$\text{Voltage-feed time constant } I_{CM} = 1\text{ mA};$$

$$V_{CE} = 5\text{ V}$$

$$\tau_v < 0.20\text{ }\mu\text{s}$$

Collector capacitance at $f = 1\text{ MHz}$

$$I_E = I_e = 0; V_{CB} = 5\text{ V}$$

$$C_c < 30\text{ pF}$$

Emitter capacitance at $f = 1\text{ MHz}$

$$I_C = I_c = 0; V_{EB} = 5\text{ V}$$

$$C_e < 30\text{ pF}$$

Transition frequency

$$-I_E = 3\text{ mA}; V_{CB} = 5\text{ V} \left\{ \begin{array}{l} \text{ASY73} \\ \text{ASY74} \\ \text{ASY75} \end{array} \right.$$

$$f_T > 4\text{ MHz}$$

$$f_T > 6\text{ MHz}$$

$$f_T > 10\text{ MHz}$$

SILICON PLANAR EPITAXIAL TRANSISTOR

N-P-N transistor in a TO-39 metal envelope primarily intended for use as high current switching device, e.g. inverters and switching regulators.

| QUICK REFERENCE DATA | | | |
|---|-----------|------|-----------------|
| Collector-base voltage (open emitter) | V_{CBO} | max. | 120 V |
| Collector-emitter voltage (open base) | V_{CEO} | max. | 60 V |
| Collector-current (peak value) | I_{CM} | max. | 5.0 A |
| Total power dissipation up to $T_{case} = 25^{\circ}C$ | P_{tot} | max. | 5.0 W |
| Junction temperature | T_j | max. | 200 $^{\circ}C$ |
| D. C. current gain $I_C = 2 A; V_{CE} = 2 V$ | h_{FE} | | 40 to 150 |
| Transition frequency at $f = 35 MHz$ $I_C = 0.5 A; V_{CE} = 5 V$ | f_T | > | 70 MHz |
| Turn off time when switched from $I_C = 5 A; I_B = 0.5 A$ to cut-off with $-I_{BM} = 0.5 A$ | t_{off} | < | 1.2 μs |

MECHANICAL DATA

Dimensions in mm

Collector connected to case

TO-39

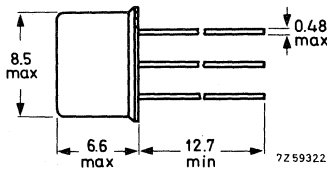
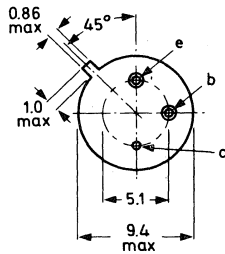

max. lead diameter is guaranteed only for 12.7 mm

Accessories supplied on request: 56218, 56254

RATINGS Limiting values in accordance with the Absolute Maximum System (IEC 134)Voltages

| | | | | |
|---------------------------------------|-----------|------|-----|---|
| Collector-base voltage (open emitter) | V_{CB0} | max. | 120 | V |
| Collector-emitter voltage (open base) | V_{CEO} | max. | 60 | V |
| Emitter-base voltage (open collector) | V_{EBO} | max. | 6 | V |

Currents

| | | | | |
|--------------------------------|----------|------|-----|---|
| Collector current (d. c.) | I_C | max. | 2.0 | A |
| Collector current (peak value) | I_{CM} | max. | 5.0 | A |
| Base current (d. c.) | I_B | max. | 1.0 | A |

Power dissipation

| | | | | |
|---|-----------|------|------|---|
| Total power dissipation up to $T_{case} = 25^\circ C$ | P_{tot} | max. | 5.0 | W |
| up to $T_{amb} = 25^\circ C$ | P_{tot} | max. | 0.87 | W |

Temperatures

| | | | |
|----------------------|-----------|-------------|------------|
| Storage temperature | T_{stg} | -55 to +200 | $^\circ C$ |
| junction temperature | T_j | max. 200 | $^\circ C$ |

THERMAL RESISTANCE

| | | | | |
|--------------------------------------|---------------|---|-----|--------------|
| From junction to ambient in free air | $R_{th\ j-a}$ | = | 200 | $^\circ C/W$ |
| From junction to case | $R_{th\ j-c}$ | = | 35 | $^\circ C/W$ |

CHARACTERISTICS

$T_j = 25^\circ\text{C}$ unless otherwise specified

Collector cut-off current

$V_{EB} = 0; V_{CE} = 60\text{ V}$

$I_{CES} < 10\ \mu\text{A}$

Emitter cut-off current

$I_C = 0; V_{EB} = 4\text{ V}$

I_{EBO} typ. 0.01 μA
 $< 10\ \mu\text{A}$

Saturation voltages

$I_C = 5\text{ A}; I_B = 0.5\text{ A}$

V_{CEsat} typ. 0.77 V
 $< 1.0\text{ V}$

V_{BEsat} typ. 1.43 V
 $< 1.8\text{ V}$

D. C. current gain

$I_C = 1.0\text{ A}; V_{CE} = 2.0\text{ V}$

h_{FE} typ. 130

$I_C = 1.5\text{ A}; V_{CE} = 0.6\text{ V}$

h_{FE} typ. 60

$I_C = 2.0\text{ A}; V_{CE} = 2.0\text{ V}$

h_{FE} typ. 110
 $40\text{ to }150$

Collector capacitance at $f = 1\text{ MHz}$

$I_E = I_e = 0; V_{CB} = 10\text{ V}$

C_c typ. 36 pF
 $< 100\text{ pF}$

Emitter-capacitance at $f = 1\text{ MHz}$

$I_C = I_c = 0; V_{EB} = 0.5\text{ V}$

C_e typ. 345 pF

Transition frequency at $f = 35\text{ MHz}$

$I_C = 0.5\text{ A}; V_{CE} = 5\text{ V}$

$f_T > 70\text{ MHz}$
 $\text{typ. } 100\text{ MHz}$

Turn on time when switched from

$-V_{BE} = 2.0\text{ V}$ to $I_C = 5\text{ A}; I_B = 0.5\text{ A}$
 with $I_{BM} = 0.5\text{ A}$

t_{on} typ. 0.2 μs
 $< 0.6\ \mu\text{s}$

Turn off time when switched from

$I_C = 5\text{ A}; I_B = 0.5\text{ A}$ to $-V_{BE} = 2.0\text{ V}$
 with $-I_{BM} = 0.5\text{ A}$

t_{off} typ. 0.34 μs
 $< 1.2\ \mu\text{s}$

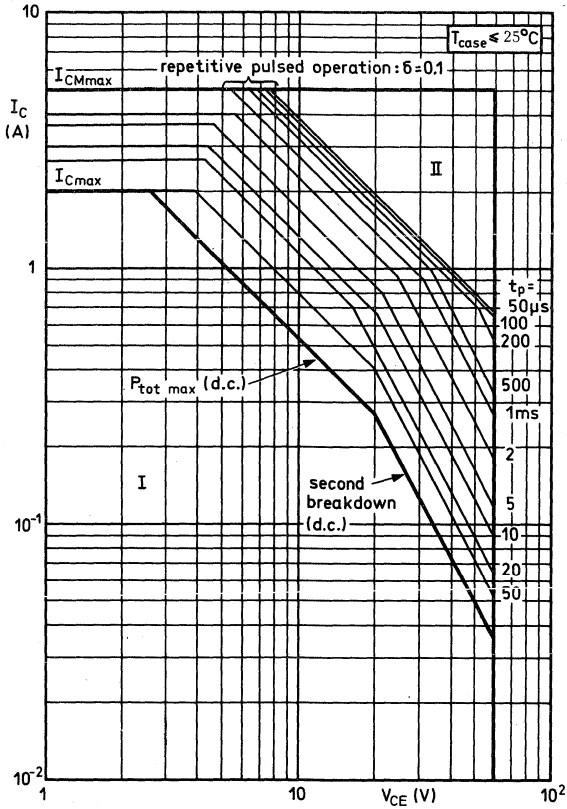

Safe Operation Area with the transistor forward biased

- I Region of permissible d.c. operation
- II Permissible extension for repetitive pulsed operation

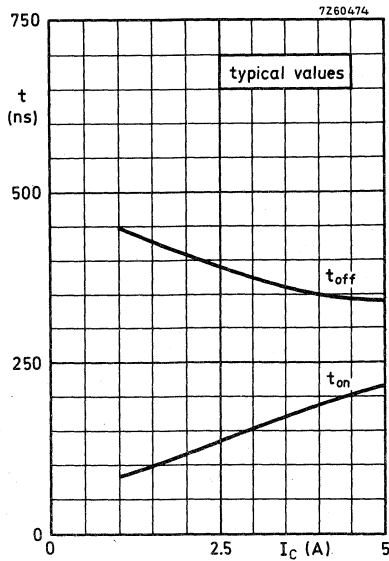
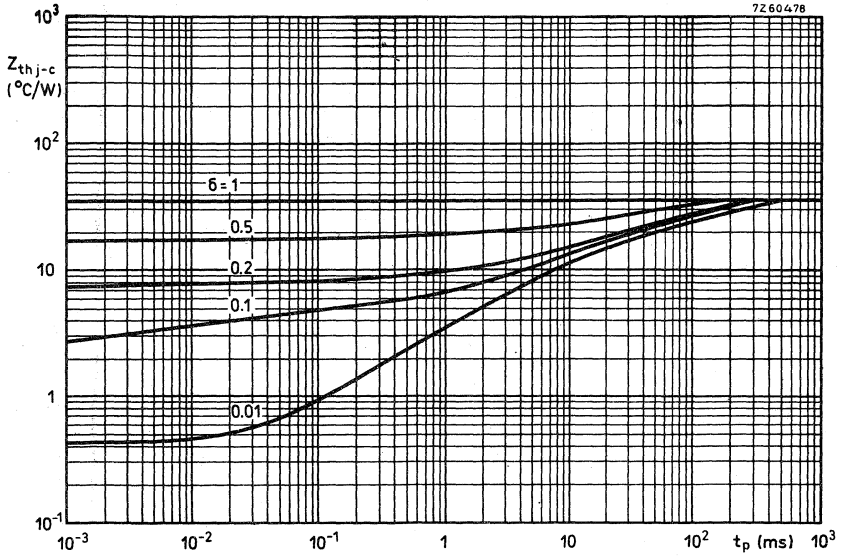

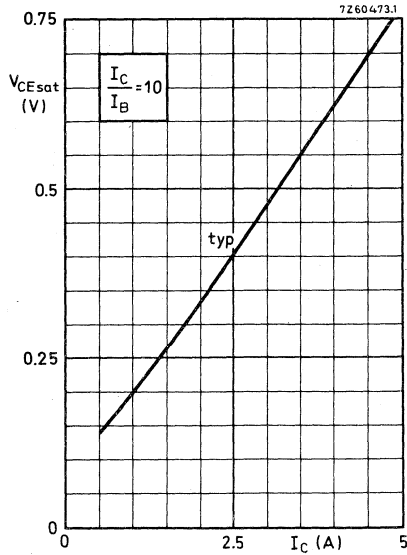
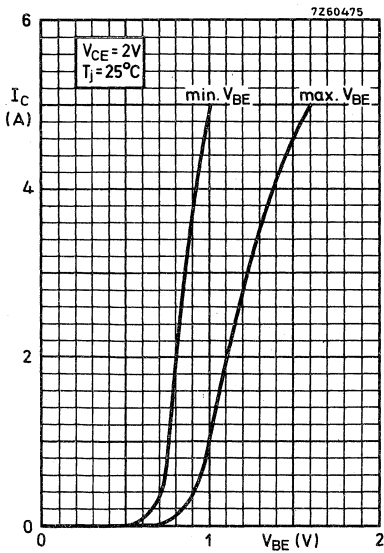
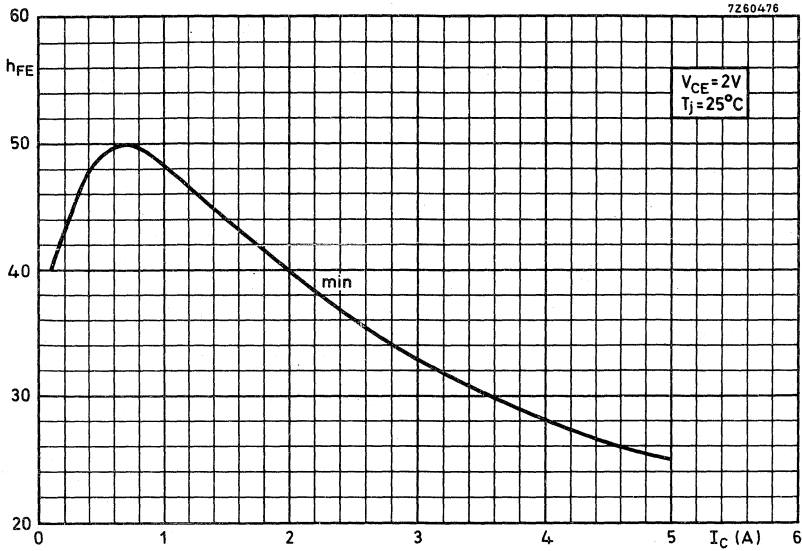

SILICON CONTROLLED SWITCH

The BR101 is a planar p-n-p-n switch in a TO-72 metal envelope, intended for time base circuits and other television applications. It is also suitable as trigger device for thyristors. It is an integrated pnp-npn transistor pair of which all electrodes are accessible. The collector of the n-p-n transistor is connected to the case.

QUICK REFERENCE DATA

| | | | |
|---|------------|------|------------------------|
| P-N-P transistor | | | |
| Emitter-base voltage (open collector) | $-V_{EBO}$ | max. | 50 V |
| N-P-N transistor | | | |
| Collector-base voltage (open emitter) | V_{CBO} | max. | 50 V |
| Repetitive peak emitter current | $-I_{ERM}$ | max. | 2,5 A |
| Total power dissipation up to $T_{amb} = 25\text{ }^{\circ}\text{C}$ | P_{tot} | max. | 275 mW |
| Junction temperature | T_j | max. | 150 $^{\circ}\text{C}$ |
| Forward on-state voltage | | | |
| $I_A = 50\text{ mA}; I_{AG} = 0; R_{KG-K} = 10\text{ k}\Omega$ | V_{AK} | < | 1,4 V |
| Holding current | | | |
| $I_{AG} = 10\text{ mA}; -V_{BB} = 2\text{ V}; R_{KG-K} = 10\text{ k}\Omega$ | I_H | < | 1,0 mA |

MECHANICAL DATA

Dimensions in mm

Collector of the n-p-n transistor
(anode gate) connected to the case.
TO-72

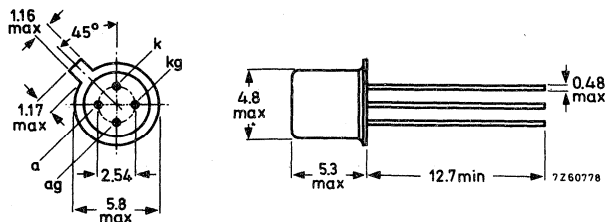

Accessories supplied on request: 56246; 56263.

RATINGS Limiting values in accordance with the Absolute Maximum System (IEC134)

Voltages

| | | p-n-p | n-p-n | |
|--|-----------|----------|-------|---|
| Collector-base voltage (open emitter) | V_{CBO} | max. -50 | 50 | V |
| Collector-emitter voltage ($R_{BE} = 10\text{ k}\Omega$) | V_{CER} | max. - | 50 | V |
| Collector-emitter voltage (open base) | V_{CEO} | max. -50 | - | V |
| Emitter-base voltage (open collector) | V_{EBO} | max. -50 | 5 1) | V |

Currents

| | | | | |
|---|-----------|----------|--------|----|
| Emitter current (d. c.) | I_E | max. 175 | -175 | mA |
| Repetitive peak emitter current $t_p = 10\ \mu\text{s}; \delta = 0,01$ | I_{ERM} | max. 2,5 | -2,5 | A |
| Collector current (d. c.) | I_C | max. - | 175 2) | mA |
| Collector current (peak value) | I_{CM} | max. - | 175 | mA |

Power dissipation

| | | | | |
|--|-----------|----------|--|----|
| Total power dissipation up to $T_{amb} = 25\ ^\circ\text{C}$ | P_{tot} | max. 275 | | mW |
|--|-----------|----------|--|----|

Temperatures

| | | | | |
|--------------------------------|-----------|-------------|--|------------------|
| Storage temperature | T_{stg} | -65 to +200 | | $^\circ\text{C}$ |
| Operating junction temperature | T_j | max. 150 | | $^\circ\text{C}$ |

THERMAL RESISTANCE

| | | | | |
|--------------------------|---------------|---|------|----------------------------|
| From junction to ambient | $R_{th\ j-a}$ | = | 0,45 | $^\circ\text{C}/\text{mW}$ |
|--------------------------|---------------|---|------|----------------------------|

1) Exceeding of this voltage is allowed during the discharge of a capacitor of max. 390 pF, provided the charge does not exceed 50 nC.

2) Provided the I_E rating will not be exceeded.

MEANING OF SYMBOLS , used in the schematic presentation of the S. C. S.

2 transistors equivalent circuit

n-p-n transistor + p-n-p transistor

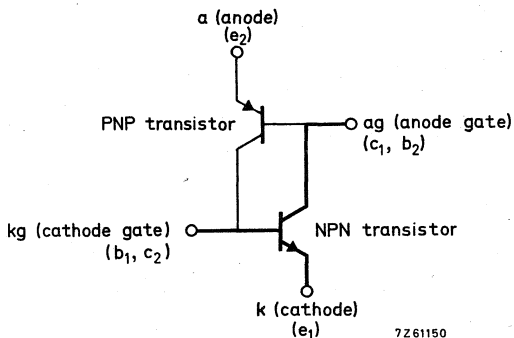

p-n-p-n S.C.S. equivalent circuit

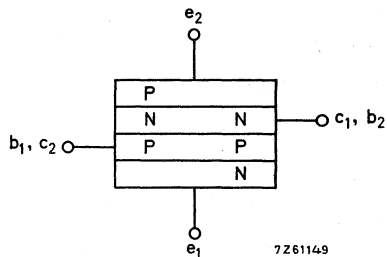

S. C. S. symbol

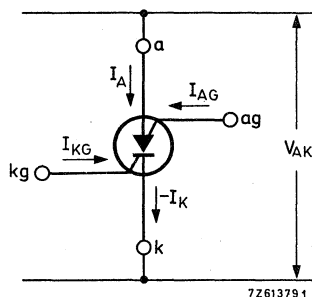

CHARACTERISTICS

$T_j = 25\text{ }^\circ\text{C}$ unless otherwise specified

Individual N-P-N transistor

Collector cut-off current

$V_{CE} = 50\text{ V}; R_{BE} = 10\text{ k}\Omega$

$I_{CER} < 0,5\text{ }\mu\text{A}$

$V_{CE} = 50\text{ V}; R_{BE} = 10\text{ k}\Omega; T_j = 150\text{ }^\circ\text{C}$

$I_{CER} < 50\text{ }\mu\text{A}$

Emitter cut-off current

$I_C = 0; V_{EB} = 5\text{ V}; T_j = 150\text{ }^\circ\text{C}$

$I_{EBO} < 50\text{ }\mu\text{A}$

CHARACTERISTICS (continued)

$T_j = 25\text{ }^\circ\text{C}$ unless otherwise specified

Individual N-P-N transistor

Saturation voltages

$I_C = 10\text{ mA}; I_B = 1\text{ mA}$

| | | | |
|-------------|---|-----|----|
| V_{CEsat} | < | 500 | mV |
| V_{BEsat} | < | 900 | mV |

D. C. current gain

$I_C = 10\text{ mA}; V_{CE} = 2\text{ V}$

| | | | |
|----------|---|----|--|
| h_{FE} | > | 50 | |
|----------|---|----|--|

Transition frequency

$I_C = 10\text{ mA}; V_{CE} = 2\text{ V}$

| | | | |
|-------|------|-----|-----|
| f_T | typ. | 300 | MHz |
|-------|------|-----|-----|

Collector capacitance

$I_E = I_e = 0; V_{CB} = 20\text{ V}$

| | | | |
|-------|---|---|----|
| C_c | < | 5 | pF |
|-------|---|---|----|

Emitter capacitance

$I_C = I_c = 0; V_{EB} = 1\text{ V}$

| | | | |
|-------|---|----|----|
| C_e | < | 25 | pF |
|-------|---|----|----|

Individual P-N-P transistor

Collector cut-off current

$I_B = 0; -V_{CE} = 50\text{ V}; T_j = 150\text{ }^\circ\text{C}$

| | | | |
|------------|---|----|---------------|
| $-I_{CEO}$ | < | 50 | μA |
|------------|---|----|---------------|

Emitter cut-off current

$I_C = 0; -V_{EB} = 50\text{ V}; T_j = 150\text{ }^\circ\text{C}$

| | | | |
|------------|---|----|---------------|
| $-I_{EBO}$ | < | 50 | μA |
|------------|---|----|---------------|

D. C. current gain

$I_E = 1\text{ mA}; V_{CB} = 0$

| | | | |
|----------|--|-------------|--|
| h_{FE} | | 0,25 to 2,5 | |
|----------|--|-------------|--|

Combined device

Forward on-state voltage at $R_{KG-K} = 10\text{ k}\Omega$

$I_A = 50\text{ mA}; I_{AG} = 0$

| | | | |
|----------|---|-----|---|
| V_{AK} | < | 1,4 | V |
|----------|---|-----|---|

$I_A = 1\text{ mA}; I_{AG} = 10\text{ mA}$

| | | | |
|----------|---|-----|---|
| V_{AK} | < | 1,2 | V |
|----------|---|-----|---|

Holding current at $R_{KG-K} = 10\text{ k}\Omega$

$I_{AG} = 10\text{ mA}; -V_{BB} = 2\text{ V}$

| | | | |
|-------|---|-----|----|
| I_H | < | 1,0 | mA |
|-------|---|-----|----|

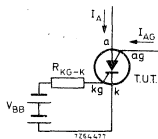

SILICON CONTROLLED SWITCH

The BRY39 is a planar p-n-p-n switch in a TO-72 metal envelope, intended as driver for numerical indicator tubes and other switching applications.

It is an integrated pnp-npn transistor pair of which all electrodes are accessible.

The collector of the n-p-n transistor is connected to the case.

For the applications of the BRY39 as THYRISTOR TETRODE see Handbook Part 1a, section THYRISTORS, DIACS, TRIACS and as PROGRAMMABLE UNIJUNCTION TRANSISTOR see Handbook Part 3, section SWITCHING TRANSISTORS.

QUICK REFERENCE DATA

| | | | |
|---|------------|------|------------------------|
| P-N-P transistor | | | |
| Emitter-base voltage (open collector) | $-V_{EBO}$ | max. | 70 V |
| N-P-N transistor | | | |
| Collector-base voltage (open emitter) | V_{CBO} | max. | 70 V |
| Repetitive peak emitter current | $-I_{ERM}$ | max. | 2,5 A |
| Total power dissipation up to $T_{amb} = 25\text{ }^{\circ}\text{C}$ | P_{tot} | max. | 275 mW |
| Junction temperature | T_j | max. | 150 $^{\circ}\text{C}$ |
| Forward on-state voltage | | | |
| $I_A = 50\text{ mA}; I_{AG} = 0; R_{KG-K} = 10\text{ k}\Omega$ | V_{AK} | < | 1,4 V |
| Holding current | | | |
| $I_{AG} = 10\text{ mA}; -V_{BB} = 2\text{ V}; R_{KG-K} = 10\text{ k}\Omega$ | I_H | < | 1,0 mA |
| Turn-on time | t_{on} | < | 0,25 μs |
| Turn-off time | t_q | < | 5,0 μs |

MECHANICAL DATA

Dimensions in mm

Collector of the n-p-n transistor
(anode gate) connected to the case.
TO-72

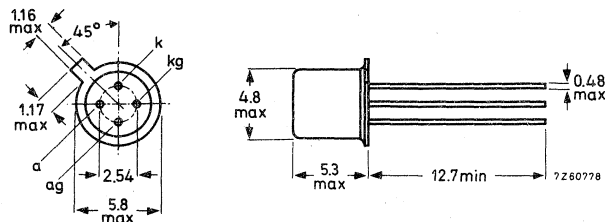

Accessories supplied on request: 56246; 56263.

RATINGS Limiting values in accordance with the Absolute Maximum System (IEC134)

Voltages

| | | p-n-p | n-p-n |
|--|-----------|-------------|---------|
| Collector-base voltage (open emitter) | V_{CBO} | max. -70 | 70 1) V |
| Collector-emitter voltage ($R_{BE} = 10\text{ k}\Omega$) | V_{CER} | max. - | 70 1) V |
| Collector-emitter voltage (open base) | V_{CEO} | max. -70 | - V |
| Emitter-base voltage (open collector) | V_{EBO} | max. -70 1) | 5 2) V |

Currents

| | | | |
|---|-----------|----------|-----------|
| Emitter current (d. c.) | I_E | max. 175 | -175 mA |
| Repetitive peak emitter current $t_p = 10\ \mu\text{s}; \delta = 0,01$ | I_{ERM} | max. 2,5 | -2,5 A |
| Collector current (d. c.) | I_C | max. - | 175 3) mA |
| Collector current (peak value) | I_{CM} | max. - | 175 4) mA |

Power dissipation

| | | | |
|--|-----------|----------|----|
| Total power dissipation up to $T_{amb} = 25\ ^\circ\text{C}$ | P_{tot} | max. 275 | mW |
|--|-----------|----------|----|

Temperatures

| | | | |
|--------------------------------|-----------|-------------|------------------|
| Storage temperature | T_{stg} | -65 to +200 | $^\circ\text{C}$ |
| Operating junction temperature | T_j | max. 150 | $^\circ\text{C}$ |

THERMAL RESISTANCE

| | | | |
|--------------------------|---------------|---|---------------------------------|
| From junction to ambient | $R_{th\ j-a}$ | = | 0,45 $^\circ\text{C}/\text{mW}$ |
|--------------------------|---------------|---|---------------------------------|

- 1) In numerical indicator tube driver circuits higher voltages are allowed, provided the collector current does not exceed a d. c. current of 1 mA.
- 2) In numerical indicator tube driver circuits higher voltages are allowed during the discharge of a capacitor of max. 390 pF, provided the charge does not exceed 50 nC.
- 3) Provided the I_E rating will not be exceeded.
- 4) During switching on, the device can withstand a discharge of a capacitor of max. 500 pF. This capacitor is charged, when the transistor is in cut-off condition, with a collector supply voltage of 160 V with a series resistance of 100 k Ω .

MEANING OF SYMBOLS, used in the schematic presentation of the S. C. S.

2 transistor equivalent circuit

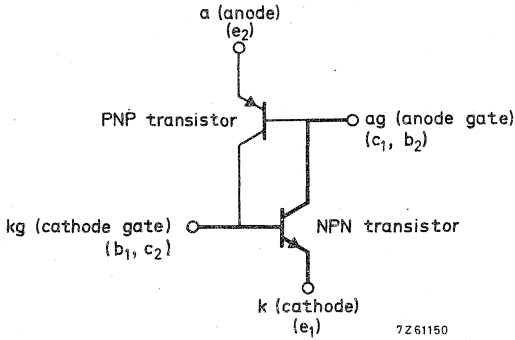

p-n-p-n S.C.S. equivalent circuit

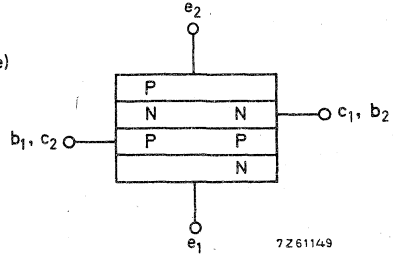

S.C.S. symbol

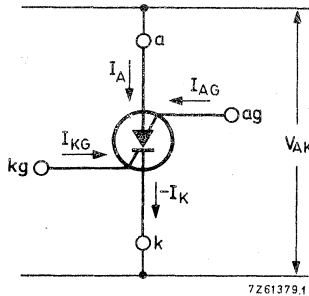

CHARACTERISTICS

$T_j = 25\text{ }^\circ\text{C}$ unless otherwise specified

Individual N-P-N transistor

Collector cut-off current

$V_{CE} = 70\text{ V}; R_{BE} = 10\text{ k}\Omega$

$I_{CER} < 100\text{ nA}$

$V_{CE} = 70\text{ V}; R_{BE} = 10\text{ k}\Omega; T_j = 150\text{ }^\circ\text{C}$

$I_{CER} < 10\text{ }\mu\text{A}$

Emitter cut-off current

$I_C = 0; V_{EB} = 5\text{ V}; T_j = 150\text{ }^\circ\text{C}$

$I_{EBO} < 10\text{ }\mu\text{A}$

CHARACTERISTICS (continued)

$T_j = 25\text{ }^\circ\text{C}$ unless otherwise specified

Individual N-P-N transistor

Saturation voltages

$I_C = 10\text{ mA}; I_B = 1\text{ mA}$

| | | | |
|-------------|---|-----|----|
| V_{CEsat} | < | 500 | mV |
| V_{BEsat} | < | 900 | mV |

D. C. current gain

$I_C = 10\text{ mA}; V_{CE} = 2\text{ V}$

| | | | |
|----------|---|----|--|
| h_{FE} | > | 50 | |
|----------|---|----|--|

Transition frequency

$I_C = 10\text{ mA}; V_{CE} = 2\text{ V}$

| | | | |
|-------|------|-----|-----|
| f_T | typ. | 300 | MHz |
|-------|------|-----|-----|

Collector capacitance

$I_E = I_C = 0; V_{CB} = 20\text{ V}$

| | | | |
|-------|---|---|----|
| C_c | < | 5 | pF |
|-------|---|---|----|

Emitter capacitance

$I_C = I_C = 0; V_{EB} = 1\text{ V}$

| | | | |
|-------|---|----|----|
| C_e | < | 25 | pF |
|-------|---|----|----|

Individual P-N-P transistor

Collector cut-off current

$I_B = 0; -V_{CE} = 70\text{ V}; T_j = 150\text{ }^\circ\text{C}$

| | | | |
|------------|---|----|---------------|
| $-I_{CEO}$ | < | 10 | μA |
|------------|---|----|---------------|

Emitter cut-off current

$I_C = 0; -V_{EB} = 70\text{ V}; T_j = 150\text{ }^\circ\text{C}$

| | | | |
|------------|---|----|---------------|
| $-I_{EBO}$ | < | 10 | μA |
|------------|---|----|---------------|

D. C. current gain

$I_E = 1\text{ mA}; V_{CB} = 0$

| | | | |
|----------|--|-------------|--|
| h_{FE} | | 0,25 to 2,5 | |
|----------|--|-------------|--|

Combined device

Forward on-state voltage at $R_{KG-K} = 10\text{ k}\Omega$

$I_A = 50\text{ mA}; I_{AG} = 0$

| | | | |
|----------|---|-----|---|
| V_{AK} | < | 1,4 | V |
|----------|---|-----|---|

$I_A = 50\text{ mA}; I_{AG} = 0; T_j = -55\text{ }^\circ\text{C}$

| | | | |
|----------|---|-----|---|
| V_{AK} | < | 1,9 | V |
|----------|---|-----|---|

$I_A = 1\text{ mA}; I_{AG} = 10\text{ mA}$

| | | | |
|----------|---|-----|---|
| V_{AK} | < | 1,2 | V |
|----------|---|-----|---|

Holding current at $R_{KG-K} = 10\text{ k}\Omega$

$I_{AG} = 10\text{ mA}; -V_{BB} = 2\text{ V}$

| | | | |
|-------|---|-----|----|
| I_H | < | 1,0 | mA |
|-------|---|-----|----|

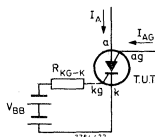

CHARACTERISTICS (continued)

$T_j = 25\text{ }^\circ\text{C}$ unless otherwise specified

Switching times see also page 6

Turn-on time when switched from

$-V_{KG-K} = 0,5\text{ V}$ to $+V_{KG-K} = 4,5\text{ V}$; $R_{KG-K} = 1\text{ k}\Omega$
 $R_{KG-K} = 10\text{ k}\Omega$

$t_{on} < 0,25\text{ }\mu\text{s}$

$t_{on} < 1,5\text{ }\mu\text{s}$

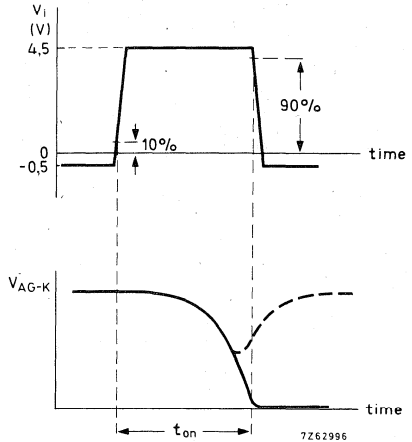
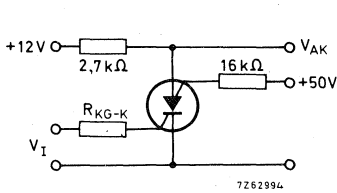

Pulse duration increased until dashed curve disappears

Turn-off time

$R_{KG-K} = 1\text{ k}\Omega$
 $R_{KG-K} = 10\text{ k}\Omega$

$t_q < 5\text{ }\mu\text{s}$

$t_q < 8\text{ }\mu\text{s}$

$T_j = 125\text{ }^\circ\text{C}$; $R_{KG-K} = 10\text{ k}\Omega$

$t_q < 15\text{ }\mu\text{s}$

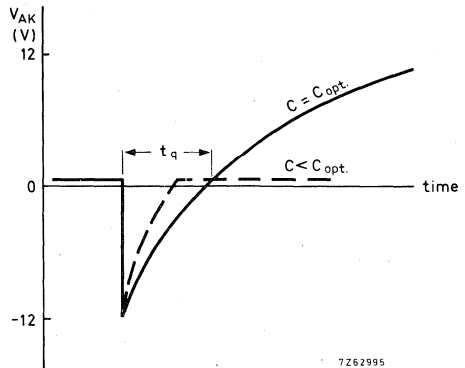
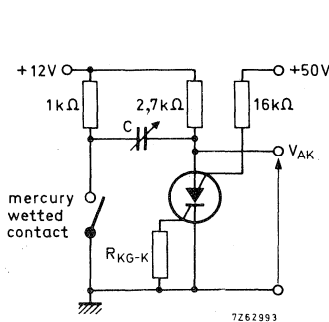

Capacitance increased until dashed curve disappears at $C = C_{opt}$

7262986

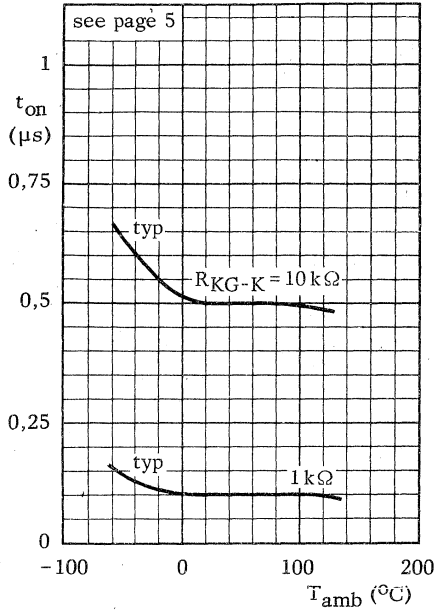

7262981

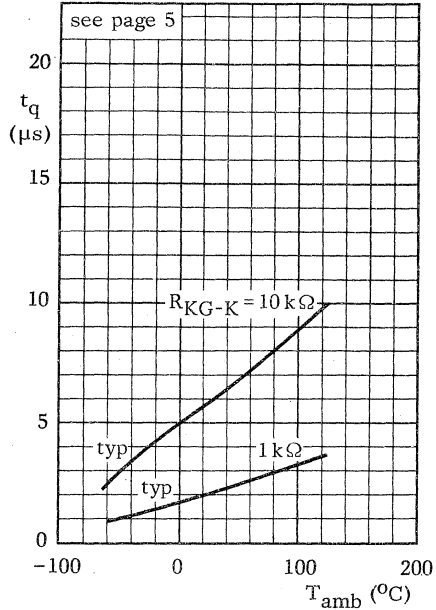

7262988

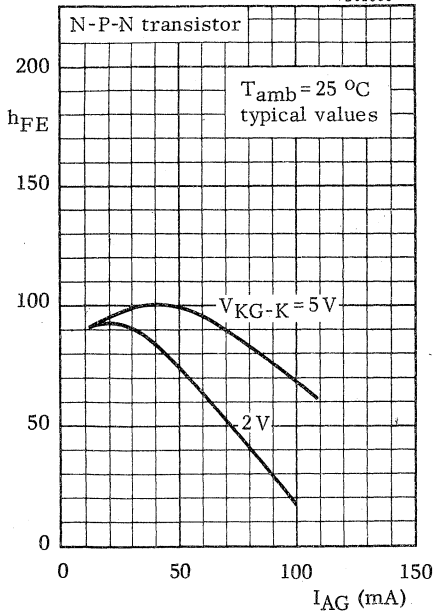

7262985

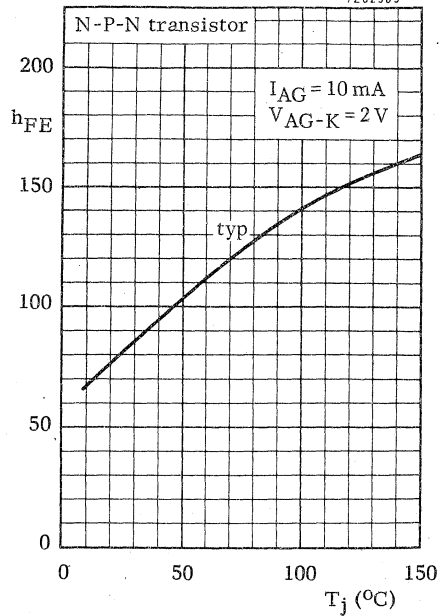

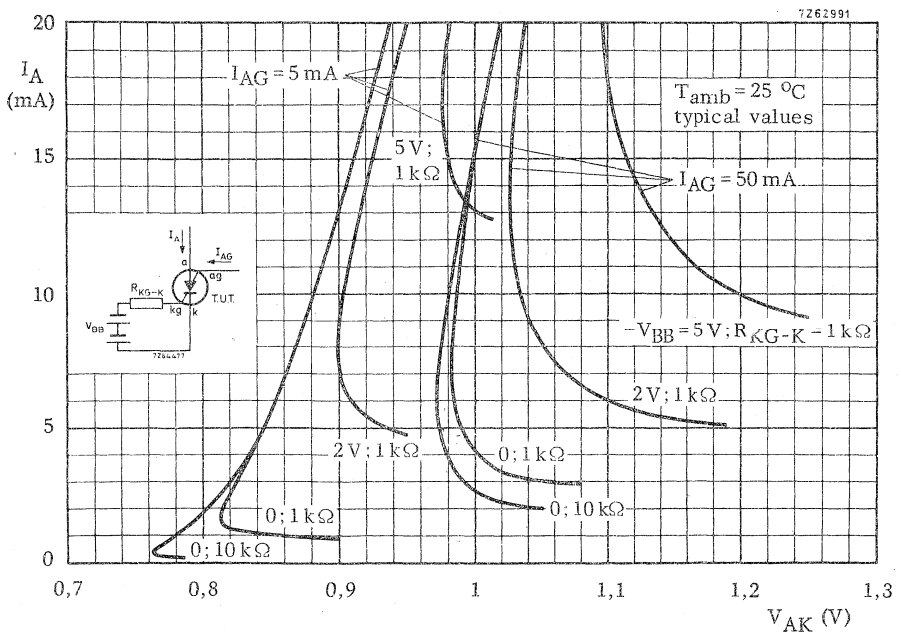
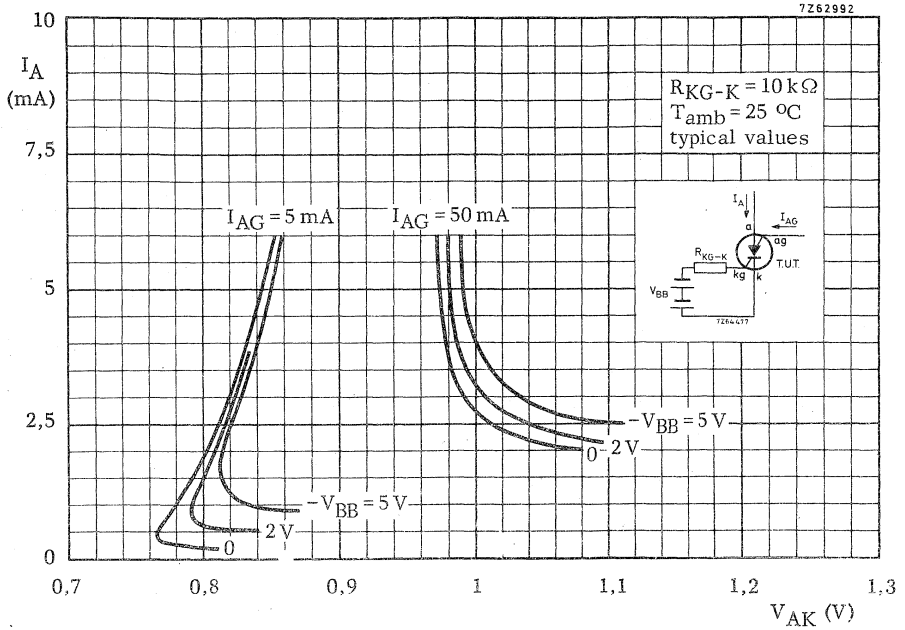

7262984

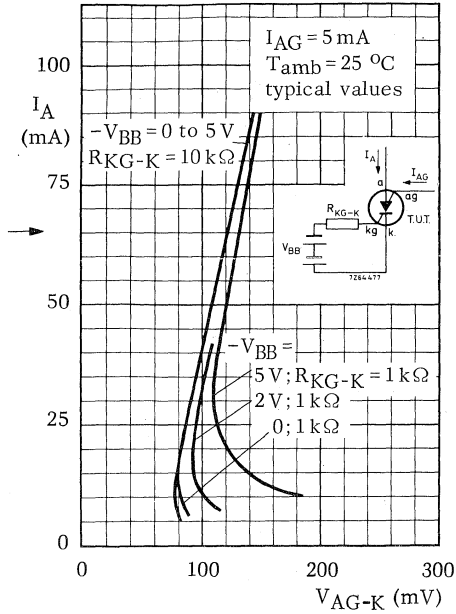

7262990

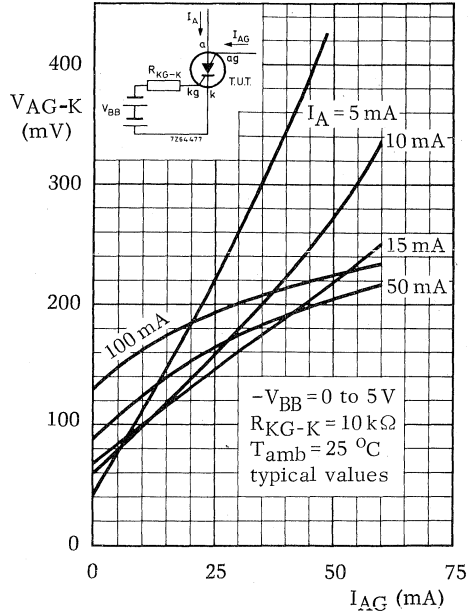

7262988

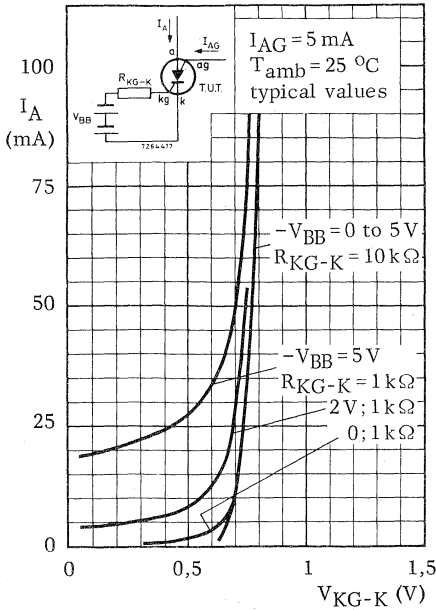

7262983

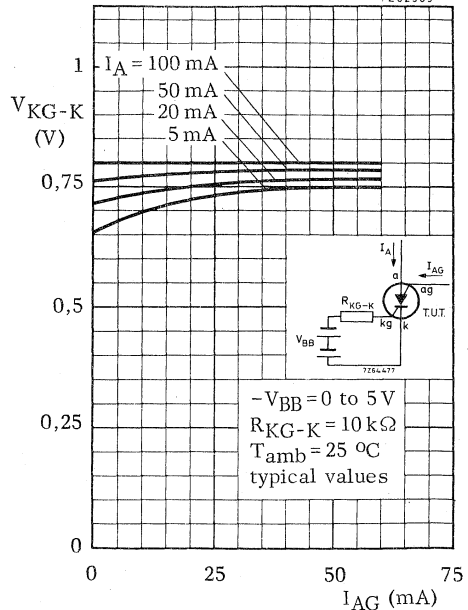

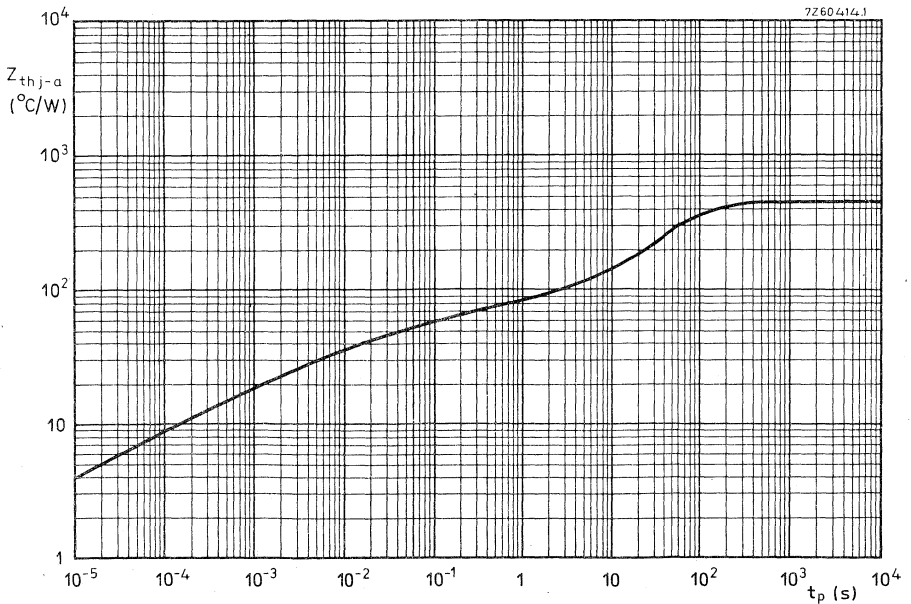
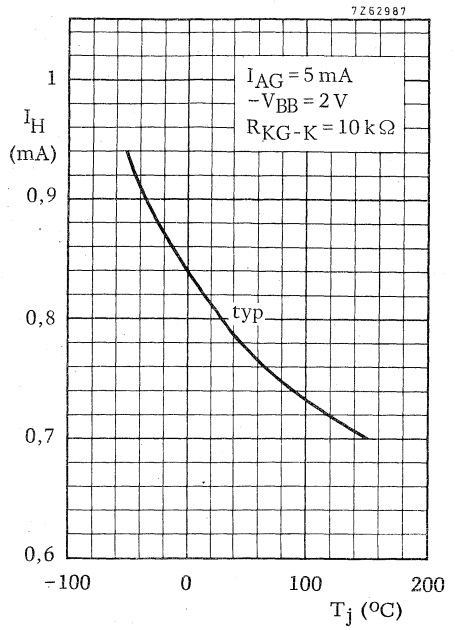
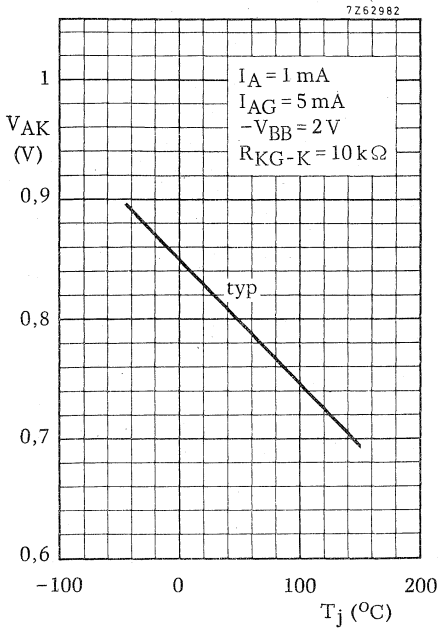

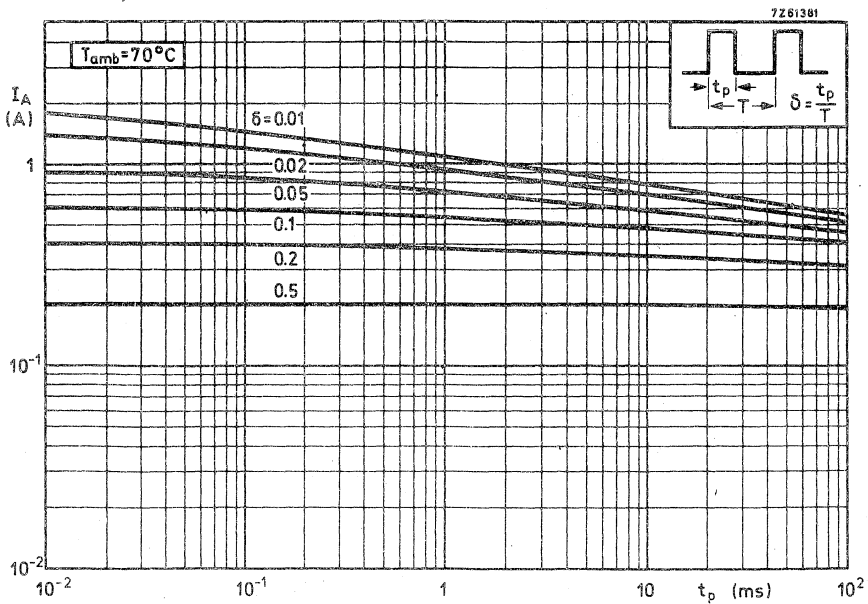
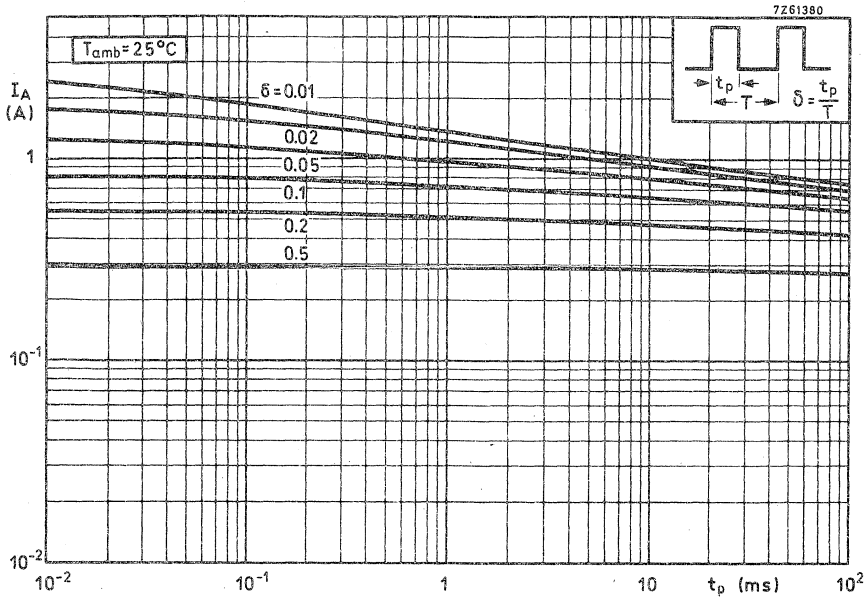

APPLICATION INFORMATION

Decade ring-counter circuit with display ($f \leq 40$ kHz)

Operating ambient temperature T_{amb} 0 to 70 °C

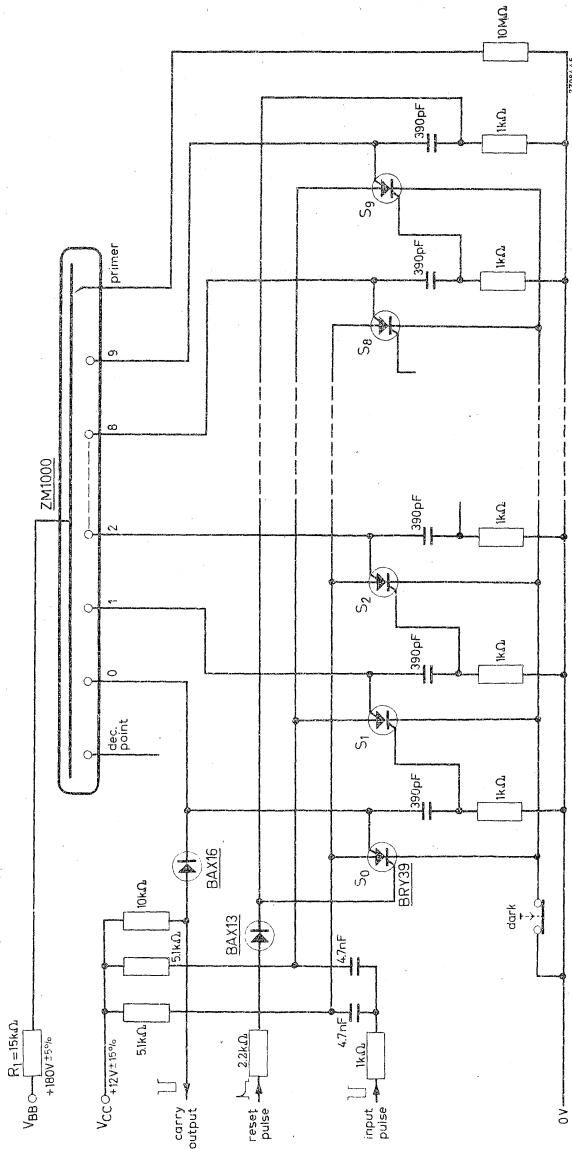

All resistors 1/8W; ±5%; except R₁: 3%

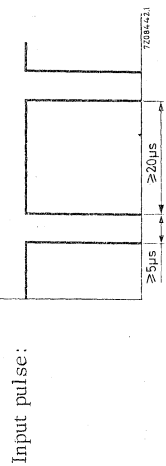

PROGRAMMABLE UNIJUNCTION TRANSISTOR

The BRY39 is a planar p-n-p-n trigger device in a TO-72 metal envelope, intended for use in switching applications such as motor control, oscillators, relay replacement, timers, pulse shaper, trigger device etc.

For the application of the BRY39 as SCS see Handbook Part 3, section SWITCHING TRANSISTORS and as THYRISTOR TETRODE see Handbook Part 1a, section THYRISTORS, DIACS, TRIACS. (For explanation of symbols see page 2).

| QUICK REFERENCE DATA | | | | |
|--|----------|------|-----|--------------------|
| Gate-anode voltage | V_{GA} | max. | 70 | V |
| Anode current (d. c.) up to $T_{case} = 85\text{ }^{\circ}\text{C}$ | I_A | max. | 250 | mA |
| Junction temperature | T_j | max. | 150 | $^{\circ}\text{C}$ |
| Peak point current $V_S = 10\text{ V}; R_G = 10\text{ k}\Omega$ | I_P | < | 5 | μA |
| Valley point current $V_S = 10\text{ V}; R_G = 10\text{ k}\Omega$ | I_V | > | 50 | μA |

MECHANICAL DATA

Dimensions in mm

Anode gate connected to case

TO-72

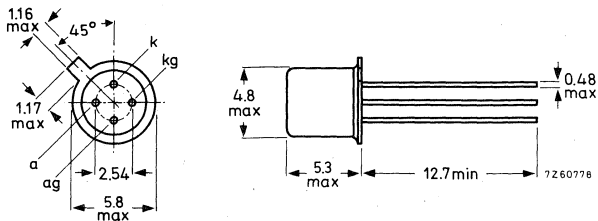

Accessories supplied on request: 56246; 56263.

RATINGS Limiting values in accordance with the Absolute Maximum System (IEC134)

Voltage

Gate-anode voltage V_{GA} max. 70 V

Currents

Anode current (d. c.) up to $T_{amb} = 25\text{ }^{\circ}\text{C}$ I_A max. 175 mA

Anode current (d. c.) up to $T_{case} = 85\text{ }^{\circ}\text{C}$ I_A max. 250 mA

Repetitive peak anode current
 $t = 10\text{ }\mu\text{s}; \delta = 0.01$ I_{ARM} max. 2.5 A

Non-repetitive peak anode current
 $t = 10\text{ }\mu\text{s}; T_j = 150\text{ }^{\circ}\text{C}$ I_{ASM} max. 3 A

Rate of rise of anode current
 up to $I_A = 2.5\text{ A}$ $\frac{dI_A}{dt}$ max. 20 A/ μs

Temperatures

Storage temperature T_{stg} -65 to +200 $^{\circ}\text{C}$

Operating junction temperature T_j max. 150 $^{\circ}\text{C}$

THERMAL RESISTANCE

From junction to ambient in free air $R_{th\ j-a} = 0.45\text{ }^{\circ}\text{C/mW}$

From junction to case $R_{th\ j-c} = 0.15\text{ }^{\circ}\text{C/mW}$

EXPLANATION OF SYMBOLS

For application of the BRY39 as programmable unijunction transistor only the anode gate is used. To simplify the symbols the term gate instead of anode gate will be applied.

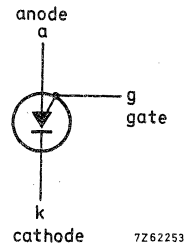
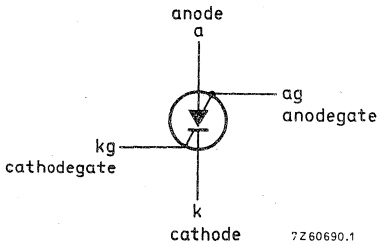

CHARACTERISTICS

$T_{amb} = 25\text{ }^{\circ}\text{C}$ unless otherwise specified

Peak point current

$V_S = 10\text{ V}; R_G = 10\text{ k}\Omega$ $I_P < 5\text{ }\mu\text{A}$

$V_S = 10\text{ V}; R_G = 1\text{ M}\Omega$ $I_P < 1\text{ }\mu\text{A}$

Valley point current

$V_S = 10\text{ V}; R_G = 10\text{ k}\Omega$ $I_V > 50\text{ }\mu\text{A}$

$V_S = 10\text{ V}; R_G = 1\text{ M}\Omega$ $I_V < 50\text{ }\mu\text{A}$

- Practical test circuit:
- 1 Remove BCY71 during measurement of I_P
 - 2 Value of R_1 depends on the voltage range of voltmeter

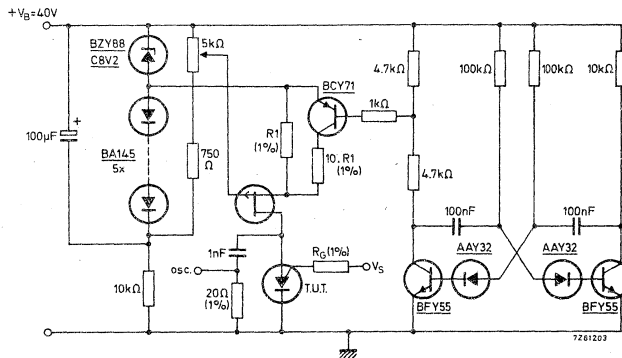

Equivalent test circuit

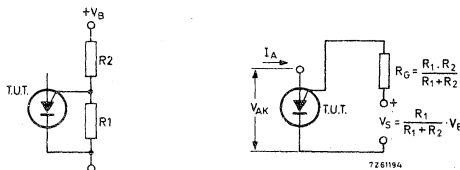

BRY39 with "program" resistors R_1 and R_2 Equivalent test circuit for characteristics testing

Offset voltage $V_{offset} = V_P - V_S (I_A = 0)$

See graph on page 6.

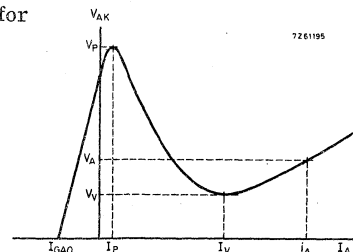

CHARACTERISTICS (continued)

$T_{amb} = 25\text{ }^{\circ}\text{C}$ unless otherwise specified

Gate-anode leakage current

$I_K = 0; V_{GA} = 70\text{ V}$

$I_{GAO} < 10\text{ nA}$

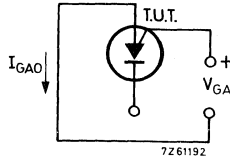

Gate-cathode leakage current

$V_{AK} = 0; V_{GK} = 70\text{ V}$

$I_{GKS} < 100\text{ nA}$

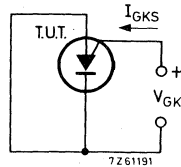

Anode voltage at $I_A = 100\text{ mA}$

$V_A < 1.4\text{ V}$

Peak output voltage

$V_{AA} = 20\text{ V}; C = 0.2\text{ }\mu\text{F}$

$V_{OM} > 6\text{ V}$

Rise time

$V_{AA} = 20\text{ V}; C = 10\text{ nF}$

$t_r < 80\text{ ns}$

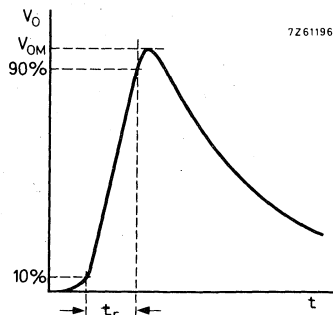
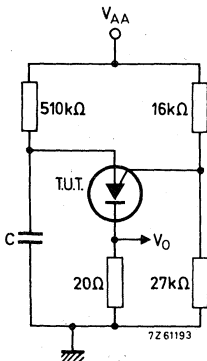

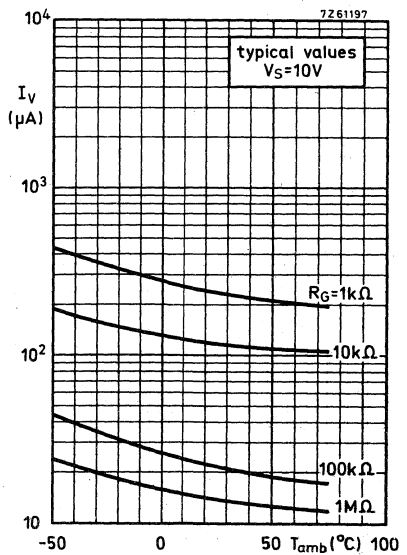
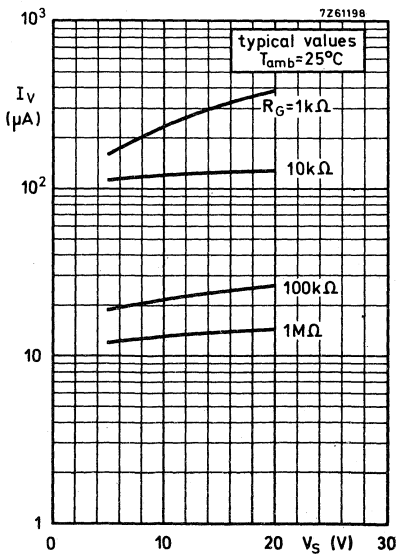
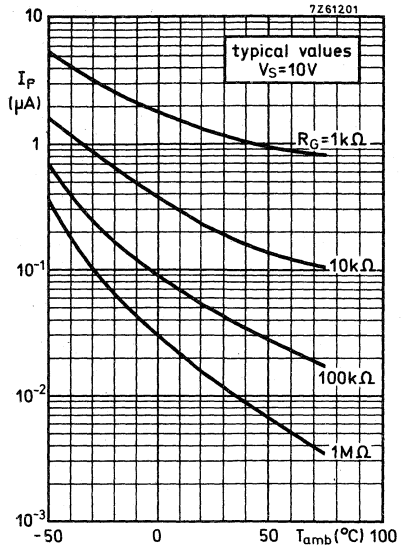
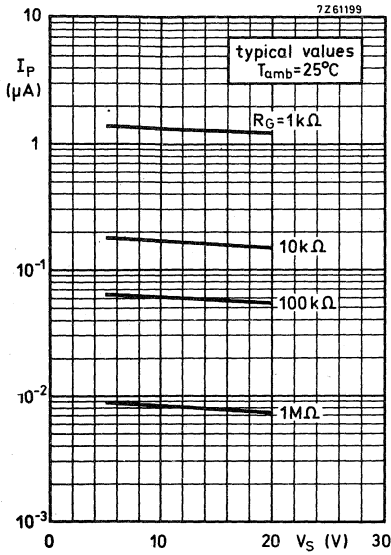

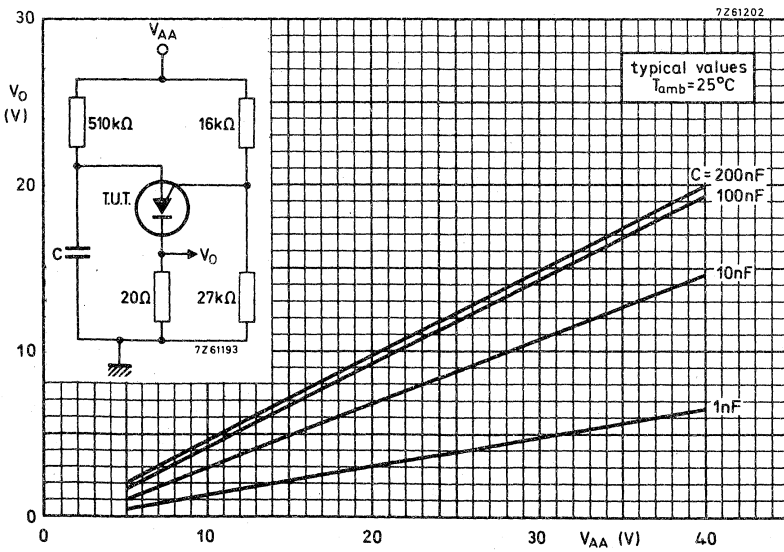
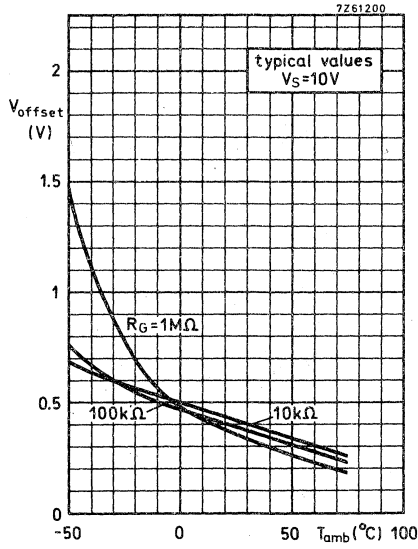

SILICON PLANAR EPITAXIAL TRANSISTOR

N-P-N transistor in a plastic TO-92 variant.

It is primarily intended for general purpose switching and as driver for numerical indicator tubes.

| QUICK REFERENCE DATA | | | |
|---|-----------|------|------------------------|
| Collector-base voltage (open emitter) | V_{CBO} | max. | 120 V |
| Collector-emitter voltage (open base) | V_{CEO} | max. | 100 V |
| Collector current (peak value) | I_{CM} | max. | 250 mA |
| Total power dissipation up to $T_{amb} = 25\text{ }^{\circ}\text{C}$ | P_{tot} | max. | 500 mW |
| Junction temperature | T_j | max. | 150 $^{\circ}\text{C}$ |
| D. C. current gain $I_C = 4\text{ mA}; V_{CE} = 1\text{ V}$ | h_{FE} | > | 20 |
| | | typ. | 80 |
| Transition frequency at $f = 35\text{ MHz}$ $I_C = 4\text{ mA}; V_{CE} = 10\text{ V}$ | f_T | > | 60 MHz |
| Turn-off time $I_{Con} = 15\text{ mA}; I_{Bon} = 1\text{ mA}; -I_{Boff} = 1\text{ mA}$ | t_{off} | < | 1 μs |

MECHANICAL DATA

Dimensions in mm

TO-92 variant

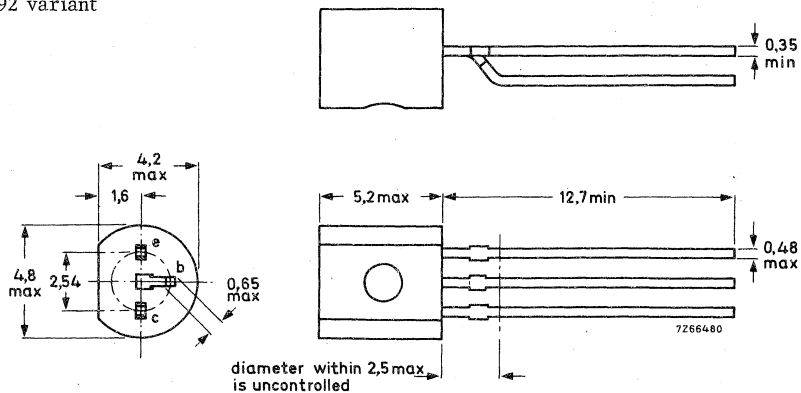

RATINGS Limiting values in accordance with the Absolute Maximum System (IEC134)

Voltages

| | | | | |
|---------------------------------------|-----------|------|-----|---|
| Collector-base voltage (open emitter) | V_{CBO} | max. | 120 | V |
| Collector-emitter voltage (open base) | V_{CEO} | max. | 100 | V |
| Emitter-base voltage (open collector) | V_{EBO} | max. | 5 | V |

Currents

| | | | | |
|---|-------------|------|-----|----|
| Collector current (d. c. or averaged over any 20 ms period) | $I_{C(AV)}$ | max. | 100 | mA |
| Collector current (peak value) | I_{CM} | max. | 250 | mA |

Power dissipation

| | | | | |
|--|-----------|------|-----|----|
| → Total power dissipation up to $T_{amb} = 25\text{ }^{\circ}\text{C}$ | P_{tot} | max. | 500 | mW |
|--|-----------|------|-----|----|

Temperatures

| | | | |
|----------------------|-----------|-------------|--------------------|
| Storage temperature | T_{stg} | -65 to +150 | $^{\circ}\text{C}$ |
| Junction temperature | T_j | max. 150 | $^{\circ}\text{C}$ |

THERMAL RESISTANCE

| | | | | |
|--------------------------------------|---------------|---|------|------------------------------|
| From junction to ambient in free air | $R_{th\ j-a}$ | = | 0,25 | $^{\circ}\text{C}/\text{mW}$ |
|--------------------------------------|---------------|---|------|------------------------------|

CHARACTERISTICS

$T_j = 25\text{ }^{\circ}\text{C}$ unless otherwise specified

Collector cut-off current

| | | | | |
|--|-----------|---|-----|---------------|
| $I_E = 0 ; V_{CB} = 90\text{ V}$ | I_{CBO} | < | 200 | nA |
| $I_E = 0 ; V_{CB} = 90\text{ V}; T_j = 150\text{ }^{\circ}\text{C}$ | I_{CBO} | < | 50 | μA |
| $V_{BE} = 0; V_{CE} = 80\text{ V}; T_j = 85\text{ }^{\circ}\text{C}$ | I_{CES} | < | 20 | μA |

Emitter cut-off current

| | | | | |
|--|-----------|---|-----|---------------|
| $I_C = 0 ; V_{EB} = 4\text{ V}$ | I_{EBO} | < | 200 | nA |
| $I_C = 0 ; V_{EB} = 4\text{ V}; T_j = 150\text{ }^{\circ}\text{C}$ | I_{EBO} | < | 50 | μA |

Saturation voltages

| | | | | |
|--|-------------|---|-----|---|
| $I_C = 4\text{ mA}; I_B = 0,4\text{ mA}$ | V_{CEsat} | < | 0,7 | V |
| | V_{BEsat} | < | 1,2 | V |
| $I_C = 50\text{ mA}; I_B = 15\text{ mA}$ | V_{CEsat} | < | 3,0 | V |

D. C. current gain

| | | | |
|---|----------|------|----|
| $I_C = 4\text{ mA}; V_{CE} = 1\text{ V}$ | h_{FE} | > | 20 |
| | | typ. | 80 |
| $I_C = 10\text{ mA}; V_{CE} = 1\text{ V}$ | h_{FE} | typ. | 80 |

CHARACTERISTICS (continued)

$T_j = 25\text{ }^\circ\text{C}$

Transition frequency at $f = 35\text{ MHz}$

$I_C = 4\text{ mA}; V_{CE} = 10\text{ V}$

$f_T > 60\text{ MHz}$

Collector capacitance at $f = 1\text{ MHz}$

$I_E = I_e = 0; V_{CB} = 10\text{ V}$

$C_c < 4,5\text{ pF}$

Emitter capacitance at $f = 1\text{ MHz}$

$I_C = I_c = 0; V_{EB} = 0,5\text{ V}$

$C_e < 17\text{ pF}$

Switching time

Turn-off time when switched from

$I_{Con} = 15\text{ mA}; I_{Bon} = 1\text{ mA}$ to cut-off with $-I_{Boff} = 1\text{ mA}$

$t_{off} < 1\text{ }\mu\text{s}$

Test circuit for measuring turn-off time:

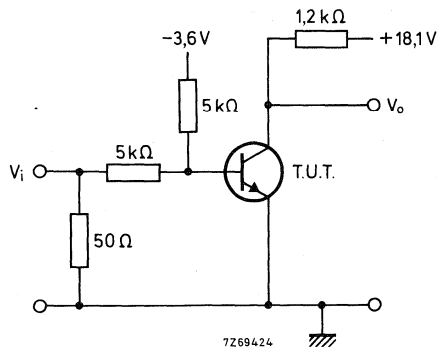

Pulse generator:

Input voltage $V_i = +10\text{ V}$

Pulse duration $t_p = 1\text{ }\mu\text{s}$

Duty factor $\delta = 0,01$

Source impedance $Z_S = 50\text{ }\Omega$

SILICON PLANAR EPITAXIAL TRANSISTORS

N-P-N transistors in TO-18 metal envelopes with the collector connected to the case. They are primarily intended for very high-speed core-driving purposes.

| QUICK REFERENCE DATA | | | | | |
|--|-------------|-------|-----|-------|--------------------|
| | | BSS40 | | BSS41 | |
| Collector-base voltage (open emitter) | V_{CBO} | max. | 60 | 60 | V |
| Collector-emitter voltage (open base) | V_{CEO} | max. | 40 | 30 | V |
| Collector current (peak value) | I_{CM} | max. | 1 | | A |
| Total power dissipation up to $T_{amb} = 25\text{ }^{\circ}\text{C}$ | P_{tot} | max. | 360 | | mW |
| Junction temperature | T_j | max. | 200 | | $^{\circ}\text{C}$ |
| D. C. current gain $I_C = 500\text{ mA}; V_{CE} = 5\text{ V}$ | h_{FE} | > | 25 | | |
| Saturation voltage $I_C = 500\text{ mA}; I_B = 50\text{ mA}$ | V_{CEsat} | < | 0,5 | | V |
| Turn-off time $I_C = 500\text{ mA}; I_B = 50\text{ mA}; -I_{BM} = 50\text{ mA}$ | t_{off} | < | 45 | | ns |

MECHANICAL DATA

Dimensions in mm

Collector connected to case

TO-18

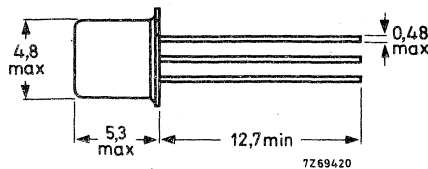
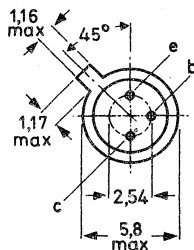

Accessories : 56246 (distance disc); 56263 (cooling fin).

RATINGS Limiting values in accordance with the Absolute Maximum System (IEC134)

Voltages

| | | BSS40 | BSS41 |
|---------------------------------------|----------------|-------|-------|
| Collector-base voltage (open emitter) | V_{CBO} max. | 60 | 60 V |
| Collector-emitter voltage (open base) | V_{CEO} max. | 40 | 30 V |
| Emitter-base voltage (open collector) | V_{EBO} max. | 5 | 5 V |

Currents

| | | | |
|--------------------------------|---------------|-----|---|
| Collector current (peak value) | I_{CM} max. | 1 | A |
| Base current (peak value) | I_{BM} max. | 0.2 | A |

Power dissipation

| | | | |
|--|----------------|-----|----|
| Total power dissipation up to $T_{amb} = 25\text{ }^{\circ}\text{C}$ | P_{tot} max. | 360 | mW |
|--|----------------|-----|----|

Temperatures

| | | | |
|----------------------|------------|-------------|--------------------|
| Storage temperature | T_{stg} | -65 to +200 | $^{\circ}\text{C}$ |
| Junction temperature | T_j max. | 200 | $^{\circ}\text{C}$ |

THERMAL RESISTANCE

| | | | | |
|--------------------------------------|---------------|---|-----|----------------------|
| From junction to ambient in free air | $R_{th\ j-a}$ | = | 480 | $^{\circ}\text{C/W}$ |
| From junction to case | $R_{th\ j-c}$ | = | 150 | $^{\circ}\text{C/W}$ |

CHARACTERISTICS

$T_j = 25\text{ }^\circ\text{C}$ unless otherwise specified

Collector cut-off current

| | | | | |
|--|-----------|---|------|---------------|
| $V_{CE} = 40\text{ V}; R_{BE} = 50\ \Omega$ | I_{CER} | < | 1 | μA |
| $V_{CE} = 40\text{ V}; R_{BE} = 50\ \Omega; T_j = 150\text{ }^\circ\text{C}$ | I_{CER} | < | 1000 | μA |

Current at reverse biased emitter junction

| | | | BSS40 | BSS41 |
|--|------------|---|-------|-----------------|
| $-V_{BE} = 4\text{ V}; V_{CE} = 40\text{ V}$ | $-I_{BEX}$ | < | 1 | μA |
| $-V_{BE} = 4\text{ V}; V_{CE} = 30\text{ V}$ | $-I_{BEX}$ | < | - | 1 μA |

Breakdown voltages

| | | | | | |
|---|---------------|---|----|----|---|
| Collector-base voltage; $I_E = 0; I_C = 100\ \mu\text{A}$ | $V_{(BR)CBO}$ | > | 60 | 60 | V |
| Collector-emitter voltage; $I_C = 1\text{ mA}; R_{BE} = 50\ \Omega$ | $V_{(BR)CER}$ | > | 60 | 50 | V |
| Collector-emitter voltage; $I_B = 0; I_C = 10\text{ mA}$ | $V_{(BR)CEO}$ | > | 40 | 30 | V |
| Emitter-base voltage; $I_C = 0; I_E = 100\ \mu\text{A}$ | $V_{(BR)EBO}$ | > | 5 | 5 | V |

Saturation voltages ¹⁾

| | | | | | |
|---|-------------|---|-----|---|---|
| $I_C = 150\text{ mA}; I_B = 10\text{ mA}$ | V_{CEsat} | < | 0,4 | V | ← |
| | V_{BEsat} | < | 1,0 | V | ← |
| $I_C = 500\text{ mA}; I_B = 50\text{ mA}$ | V_{CEsat} | < | 0,5 | V | ← |
| | V_{BEsat} | < | 1,2 | V | ← |

D. C. current gain

| | | | |
|--|----------|---|----|
| $I_C = 150\text{ mA}; V_{CE} = 5\text{ V}$ | h_{FE} | > | 30 |
| $I_C = 500\text{ mA}; V_{CE} = 5\text{ V}$ | h_{FE} | > | 25 |

Transition frequency at $f = 100\text{ MHz}$

| | | | | |
|--|-------|---|-----|-----|
| $I_C = 50\text{ mA}; V_{CE} = 10\text{ V}$ | f_T | > | 200 | MHz |
|--|-------|---|-----|-----|

Collector capacitance at $f = 1\text{ MHz}$

| | | | | |
|---------------------------------------|-------|---|----|----|
| $I_E = I_e = 0; V_{CB} = 10\text{ V}$ | C_c | < | 10 | pF |
|---------------------------------------|-------|---|----|----|

Emitter capacitance at $f = 1\text{ MHz}$

| | | | | |
|--|-------|---|----|----|
| $I_C = I_c = 0; V_{EB} = 0,5\text{ V}$ | C_e | < | 50 | pF |
|--|-------|---|----|----|

¹⁾ Measured under pulse conditions: $t_p = 300\ \mu\text{s}; \delta = 0,01$.

CHARACTERISTICS (continued)

$T_j = 25\text{ }^\circ\text{C}$ unless otherwise specified

Switching times

Turn-on time when switched from

$-V_{BE} = 2\text{ V}$ to $I_C = 500\text{ mA}$; $I_B = 50\text{ mA}$

$t_{on} < 35\text{ ns}$

Turn-off time when switched from

$I_C = 500\text{ mA}$; $I_B = 50\text{ mA}$ to cut-off with $-I_{BM} = 1\text{ mA}$

$t_{off} < 250\text{ ns}$

Turn-off time when switched from

$I_C = 500\text{ mA}$; $I_B = 50\text{ mA}$ to cut-off with $-I_{BM} = 50\text{ mA}$

$t_{off} < 45\text{ ns}$

Storage time when switched from

$I_C = 500\text{ mA}$; $I_B = 50\text{ mA}$ to cut-off with $-I_{BM} = 50\text{ mA}$

$t_s > 10\text{ ns}$

Test circuit:

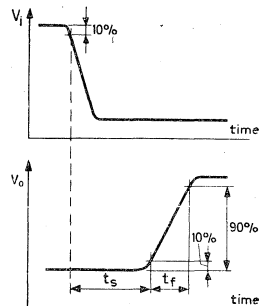
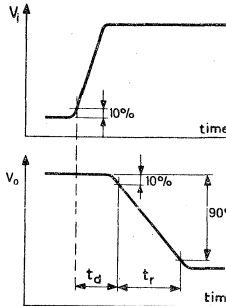
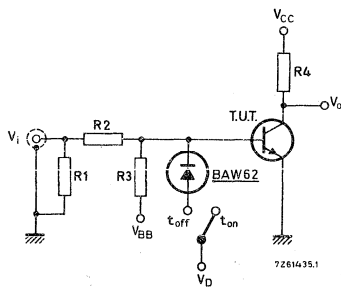

Pulse generator: Pulse duration $t_p \geq 500\text{ ns}$
 Rise time $t_r \leq 5\text{ ns}$
 Fall time $t_f \leq 5\text{ ns}$
 Source impedance $R_S = 50\text{ }\Omega$

| I_C (mA) | I_B (mA) | $-I_{BM}$ (mA) | V_{CC} (V) | R_1 (Ω) | R_2 (Ω) | R_3 (Ω) | R_4 (Ω) | turn-on time | | turn-off time | | |
|---------------|---------------|-------------------|-----------------|-----------------------|-----------------------|-----------------------|-----------------------|------------------|--------------|------------------|--------------|---------------|
| | | | | | | | | $-V_{BB}$ (V) | V_i (V) | $+V_{BB}$ (V) | V_i (V) | $-V_D$ (V) |
| 500 | 50 | 50 | 45 | 56 | 375 | 400 | 90 | 4 | 24.75 | 16.7 | 37.5 | 3 |
| 500 | 50 | 1 | 45 | 56 | 750 | ∞ | 90 | - | - | - | 37.5 | - |

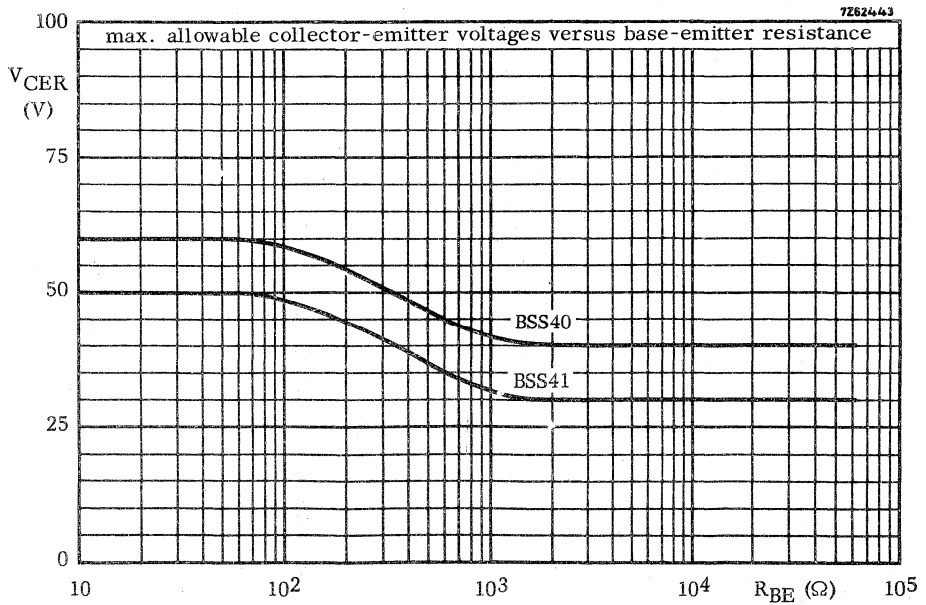
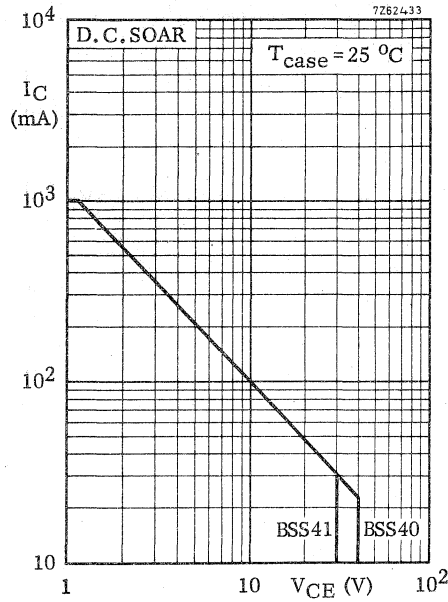

BSS40
BSS41

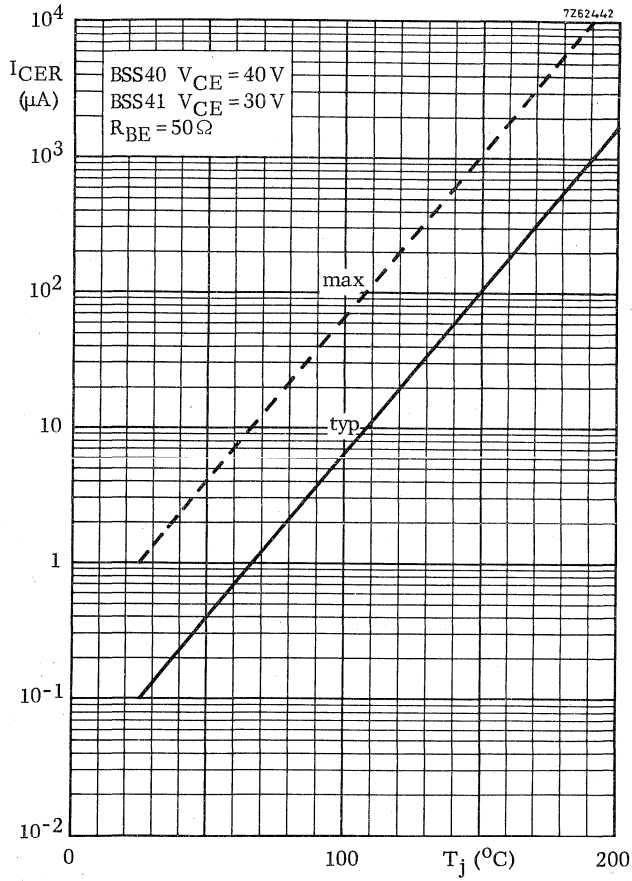

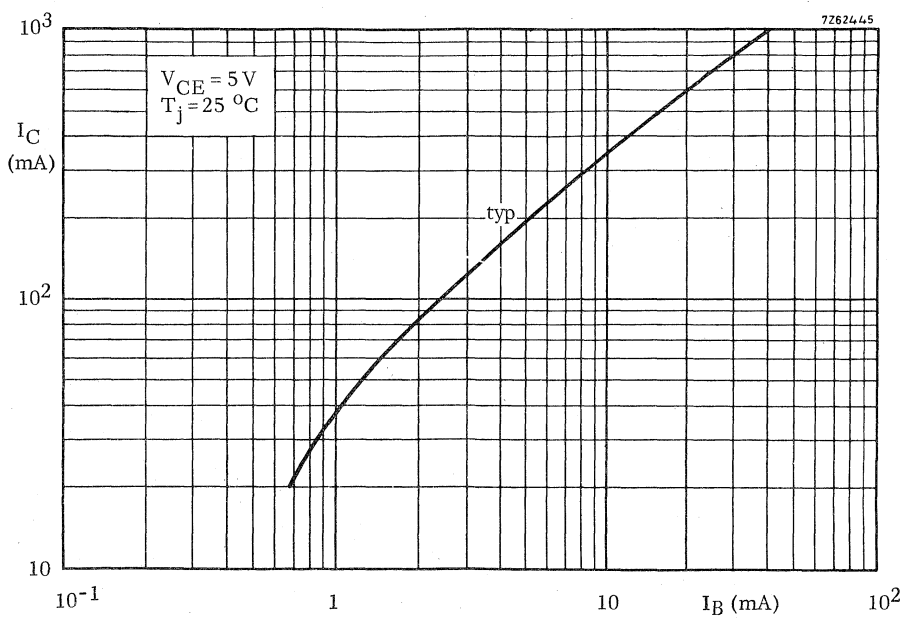
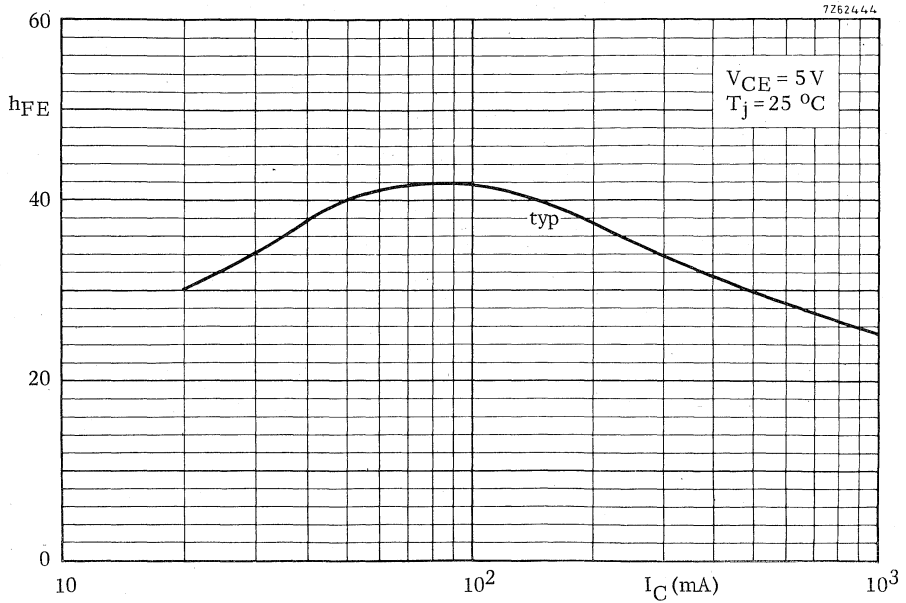

**BSS40
BSS41**

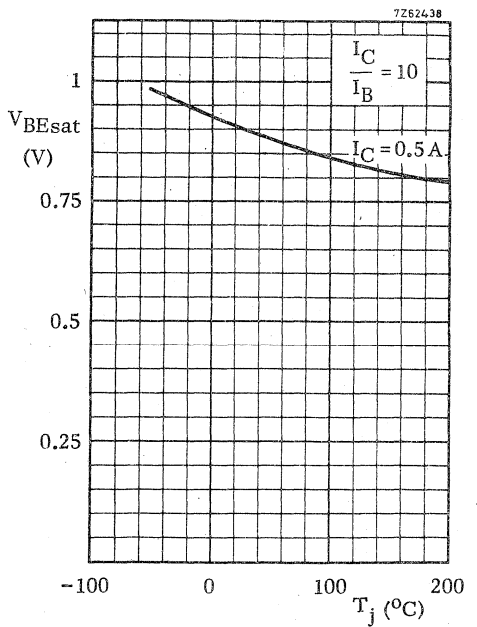
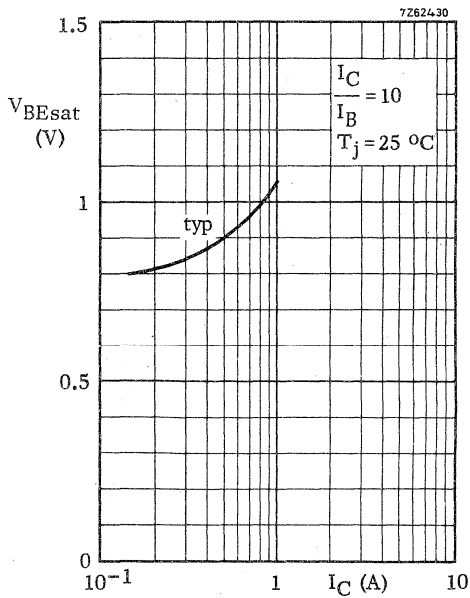
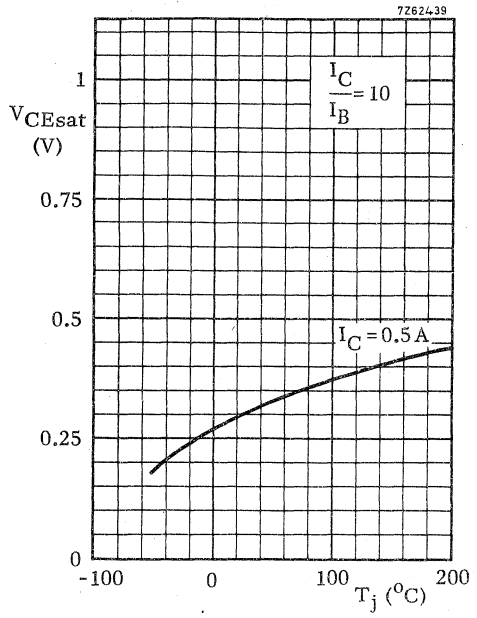
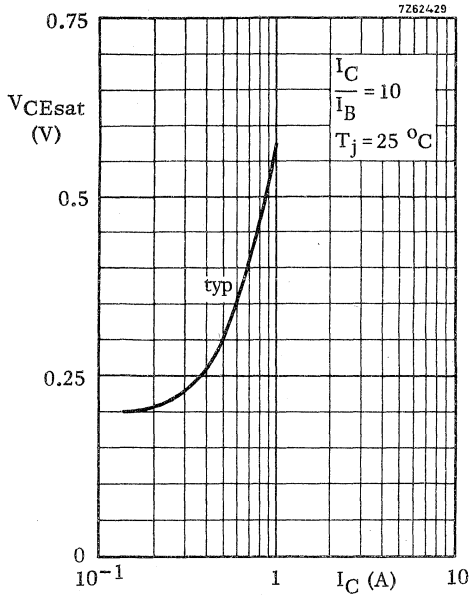

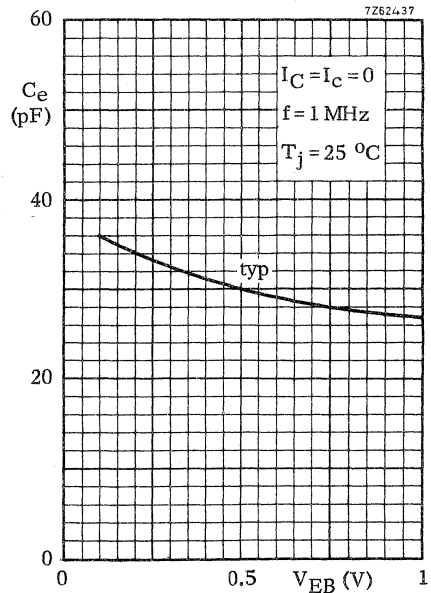
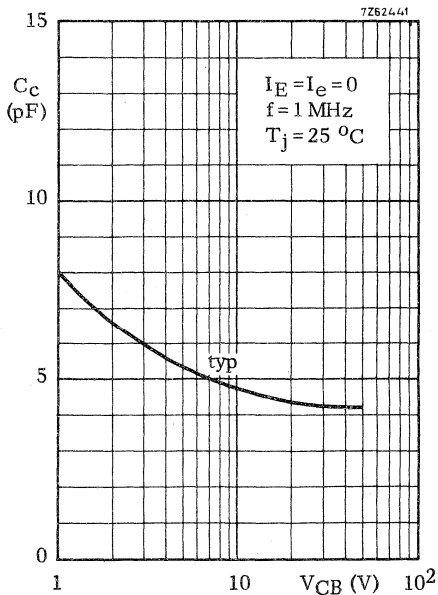
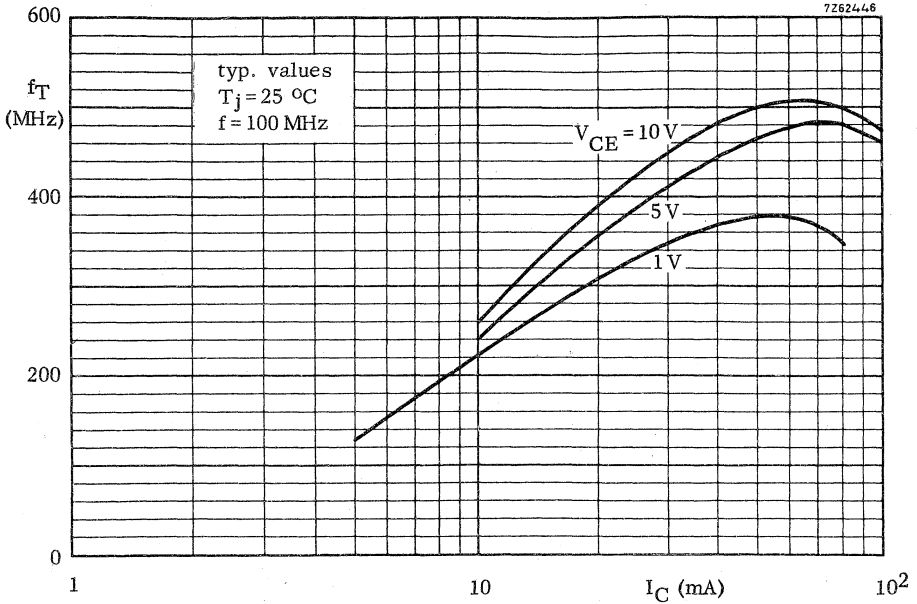

BSS40
BSS41

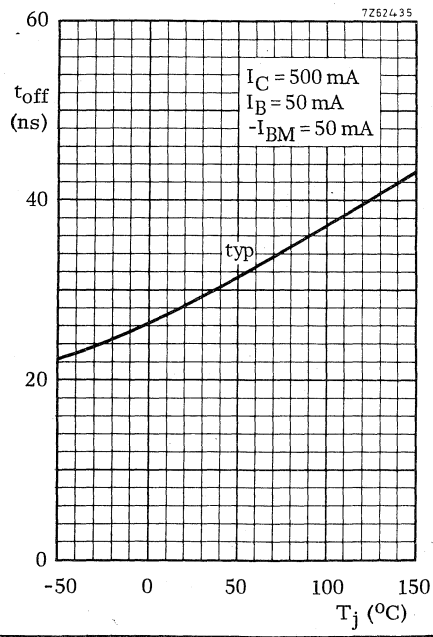
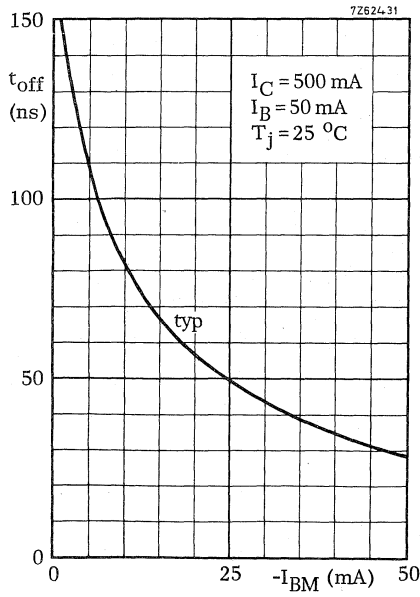
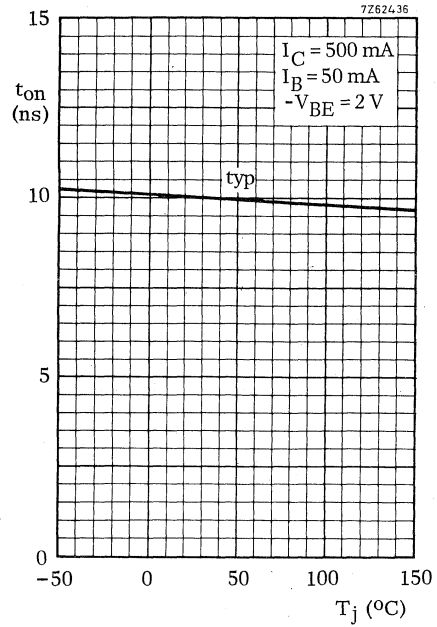
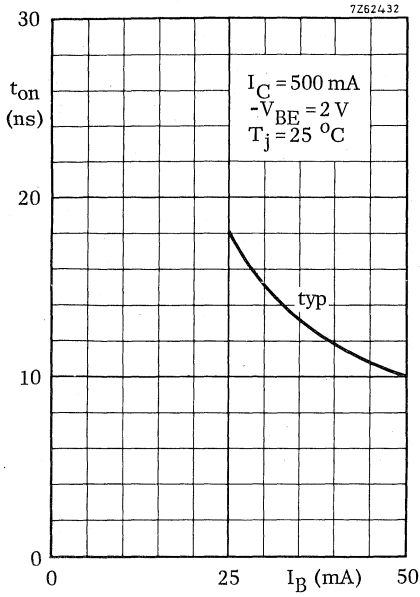

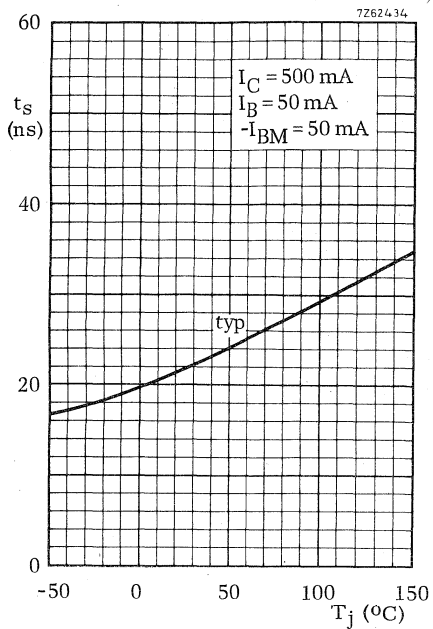
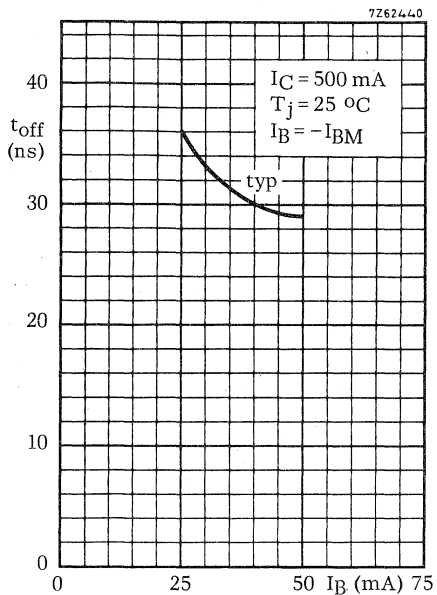

N-P-N DARLINGTON TRANSISTORS

Silicon planar transistors in a TO-39 metal envelope with the collector connected to the case, intended for industrial switching applications e.g. print hammer, solenoid, relay and lamp driving.

| QUICK REFERENCE DATA | | | | | |
|---|---------------------|-------------|-------|-------|---------------|
| | | BSS50 | BSS51 | BSS52 | |
| Collector-base voltage (open emitter) | V_{CBO} | max. 60 | 80 | 100 | V |
| Collector-emitter voltage (see page 5) | V_{CER} | max. 45 | 60 | 80 | V |
| Collector current (d. c.) | I_C | max. | | 1,0 | A |
| Total power dissipation up to $T_{amb} = 25\text{ }^\circ\text{C}$ | P_{tot} | max. | | 0,8 | W |
| Total power dissipation up to $T_{case} = 25\text{ }^\circ\text{C}$ | P_{tot} | max. | | 5,0 | W |
| D. C. current gain $I_C = 500\text{ mA}; V_{CE} = 10\text{ V}$ | h_{FE} | > | | 2000 | |
| Collector-emitter saturation voltages $I_C = 1,0\text{ A}; I_B = 1,0\text{ mA}$ | <u>BSS51</u> | V_{CEsat} | < | 1,6 | V |
| $I_C = 1,0\text{ A}; I_B = 4,0\text{ mA}$ | <u>BSS50; BSS52</u> | V_{CEsat} | < | 1,6 | V |
| Turn-off time when switched from $I_C = 500\text{ mA}; I_B = 0,5\text{ mA}$ to cut-off with $-I_{BM} = 0,5\text{ mA}$ | t_{off} | typ. | | 1,0 | μs |

MECHANICAL DATA

Dimensions in mm

Collector connected to case

TO-39

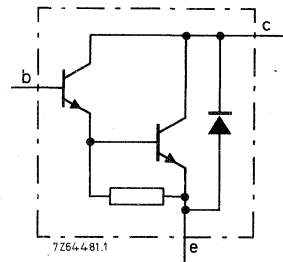
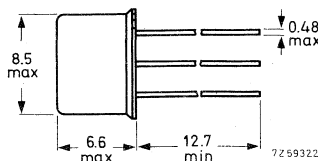
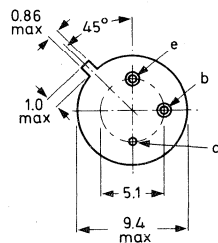

Max. lead diameter is guaranteed only for 12,7 mm

Accessories supplied on request: 56218; 56245

RATINGS Limiting values in accordance with the Absolute Maximum System (IEC134)

Voltages

| | BSS50 | BSS51 | BSS52 |
|--|--------------------|-------|-------|
| Collector-base voltage (open emitter) | V_{CBO} max. 60 | 80 | 100 V |
| Collector-emitter voltage (see page 5) | V_{CER} max. 45 | 60 | 80 V |
| Emitter-base voltage (open collector) | V_{EBO} max. 5,0 | 5,0 | 5,0 V |

Currents

| | | | |
|--------------------------------|----------|------|-------|
| Collector current (d. c.) | I_C | max. | 1,0 A |
| Collector current (peak value) | I_{CM} | max. | 2,0 A |
| Base current (d. c.) | I_B | max. | 0,1 A |

Power dissipation

| | | | |
|---|-----------|------|-------|
| Total power dissipation up to $T_{amb} = 25\text{ }^\circ\text{C}$ | P_{tot} | max. | 0,8 W |
| Total power dissipation up to $T_{case} = 25\text{ }^\circ\text{C}$ | P_{tot} | max. | 5,0 W |

Temperatures

| | | | |
|----------------------|-----------|-------------|------------------|
| Storage temperature | T_{stg} | -65 to +200 | $^\circ\text{C}$ |
| Junction temperature | T_j | max. 200 | $^\circ\text{C}$ |

THERMAL RESISTANCE

| | | | |
|--------------------------------------|---------------|---|-------------------------------|
| From junction to ambient in free air | $R_{th\ j-a}$ | = | 220 $^\circ\text{C}/\text{W}$ |
| From junction to case | $R_{th\ j-c}$ | = | 35 $^\circ\text{C}/\text{W}$ |

CHARACTERISTICS

$T_j = 25\text{ }^\circ\text{C}$ unless otherwise specified

Collector cut-off current

| | | | | | |
|---------------------------------|--------------|-----------|---|----|----|
| $I_E = 0; V_{CB} = 45\text{ V}$ | <u>BSS50</u> | I_{CBO} | < | 50 | nA |
| $I_E = 0; V_{CB} = 60\text{ V}$ | <u>BSS51</u> | I_{CBO} | < | 50 | nA |
| $I_E = 0; V_{CB} = 80\text{ V}$ | <u>BSS52</u> | I_{CBO} | < | 50 | nA |

Emitter cut-off current

| | | | | | |
|----------------------------------|--|-----------|---|----|----|
| $I_C = 0; V_{EB} = 4,0\text{ V}$ | | I_{EBO} | < | 50 | nA |
|----------------------------------|--|-----------|---|----|----|

Base-emitter voltage 1)

| | | | | | |
|---|--|----------|------|-------------|---|
| $I_C = 150\text{ mA}; V_{CE} = 10\text{ V}$ | | V_{BE} | typ. | 1,45 | V |
| | | | | 1,4 to 1,55 | V |
| $I_C = 500\text{ mA}; V_{CE} = 10\text{ V}$ | | V_{BE} | typ. | 1,55 | V |
| | | | | 1,5 to 1,65 | V |

Saturation voltages 2)

| | | | | | |
|--|--------------|-------------|---|-----|---|
| $I_C = 0,5\text{ A}; I_B = 0,5\text{ mA}$ | | V_{CEsat} | < | 1,3 | V |
| | | V_{BEsat} | < | 1,9 | V |
| $I_C = 0,5\text{ A}; I_B = 0,5\text{ mA}; T_j = 200\text{ }^\circ\text{C}$ | | V_{CEsat} | < | 1,3 | V |
| $I_C = 1,0\text{ A}; I_B = 1,0\text{ mA}$ | <u>BSS51</u> | V_{CEsat} | < | 1,6 | V |
| | | V_{BEsat} | < | 2,2 | V |
| $I_C = 1,0\text{ A}; I_B = 1,0\text{ mA}; T_j = 200\text{ }^\circ\text{C}$ | <u>BSS51</u> | V_{CEsat} | < | 2,3 | V |
| $I_C = 1,0\text{ A}; I_B = 4,0\text{ mA}$ | <u>BSS50</u> | V_{CEsat} | < | 1,6 | V |
| | | V_{BEsat} | < | 2,2 | V |
| $I_C = 1,0\text{ A}; I_B = 4,0\text{ mA}; T_j = 200\text{ }^\circ\text{C}$ | <u>BSS50</u> | V_{CEsat} | < | 1,6 | V |
| $I_C = 1,0\text{ A}; I_B = 4,0\text{ mA}$ | <u>BSS52</u> | V_{CEsat} | < | 1,6 | V |
| | | V_{BEsat} | < | 2,2 | V |
| $I_C = 1,0\text{ A}; I_B = 4,0\text{ mA}; T_j = 200\text{ }^\circ\text{C}$ | <u>BSS52</u> | V_{CEsat} | < | 1,6 | V |

D. C. current gain

| | | | | | |
|---|--|----------|---|------|---|
| $I_C = 150\text{ mA}; V_{CE} = 10\text{ V}$ | | h_{FE} | > | 1000 | ← |
| $I_C = 500\text{ mA}; V_{CE} = 10\text{ V}$ | | h_{FE} | > | 2000 | |

Small signal current gain at $f = 35\text{ MHz}$

| | | | | | |
|--|--|----------|------|-----|--|
| $I_C = 500\text{ mA}; V_{CE} = 5,0\text{ V}$ | | h_{fe} | > | 7,5 | |
| | | | typ. | 10 | |

1) V_{BE} decreases by about $3,5\text{ mV}/^\circ\text{C}$ with increasing temperature.

2) V_{BEsat} decreases by about $2,5\text{ mV}/^\circ\text{C}$ with increasing temperature.

CHARACTERISTICS (continued)

$T_j = 25\text{ }^\circ\text{C}$ unless otherwise specified

Switching times

$I_C = 0,5\text{ A}; I_B = -I_{BM} = 0,5\text{ mA}$

Turn-on time

$t_{on} < 400\text{ ns}$

Turn-off time

t_{off} typ. $1,0\text{ }\mu\text{s}$
 $< 2,0\text{ }\mu\text{s}$

$I_C = 1,0\text{ A}; I_B = -I_{BM} = 1,0\text{ mA}$

Turn-on time

$t_{on} < 400\text{ ns}$

Turn-off time

t_{off} typ. $1,0\text{ }\mu\text{s}$
 $< 2,0\text{ }\mu\text{s}$

Test circuit for 500 mA switching:

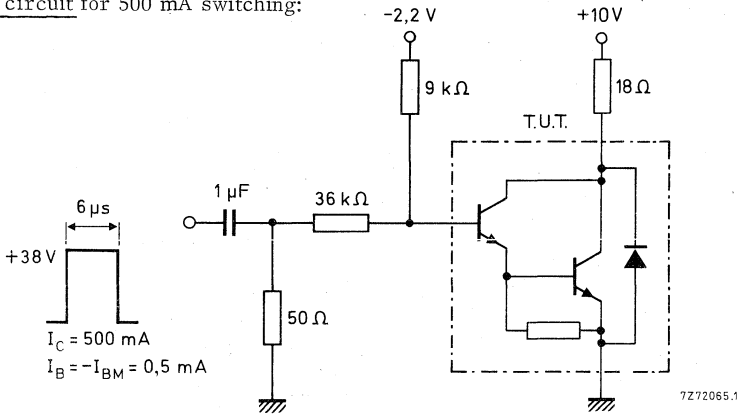

Switching waveforms:

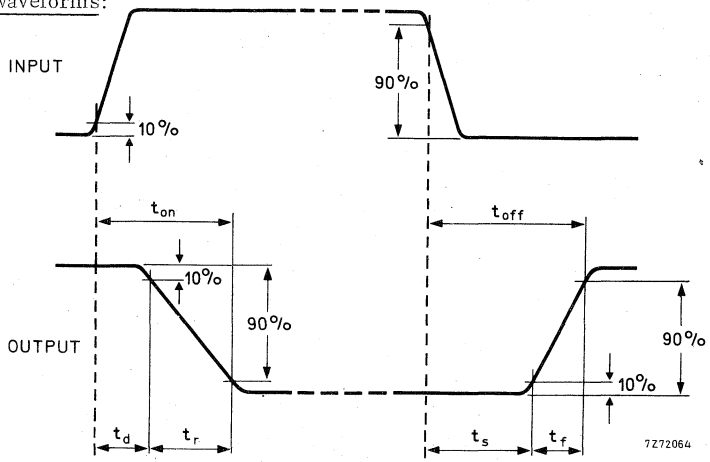

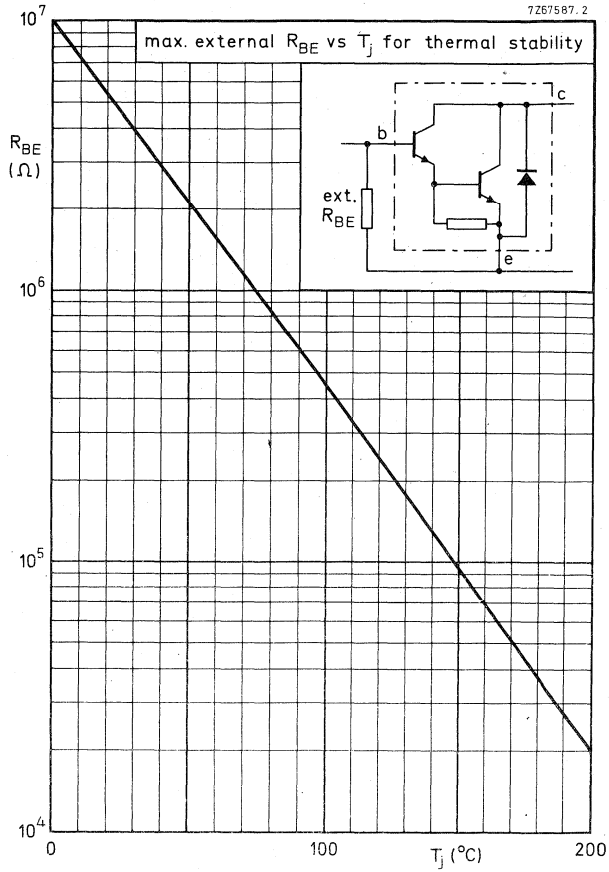

7267588.1

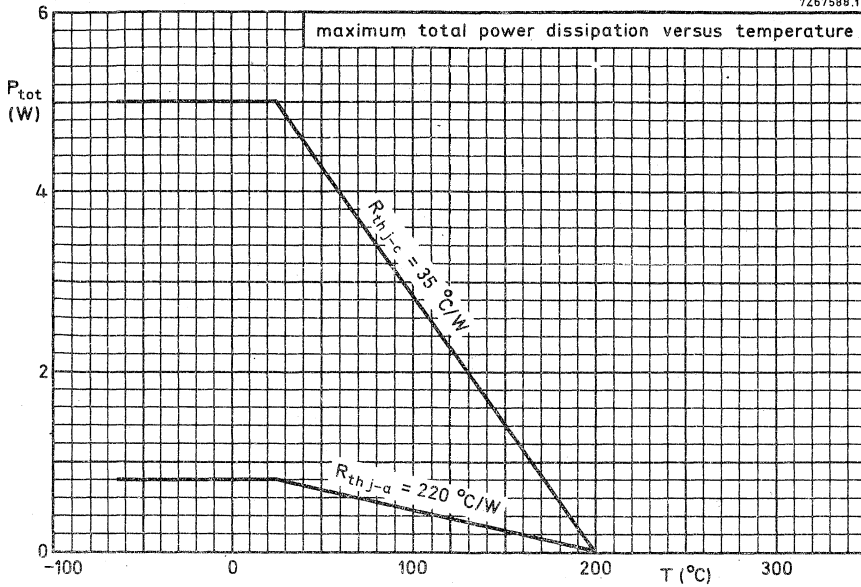

7272063

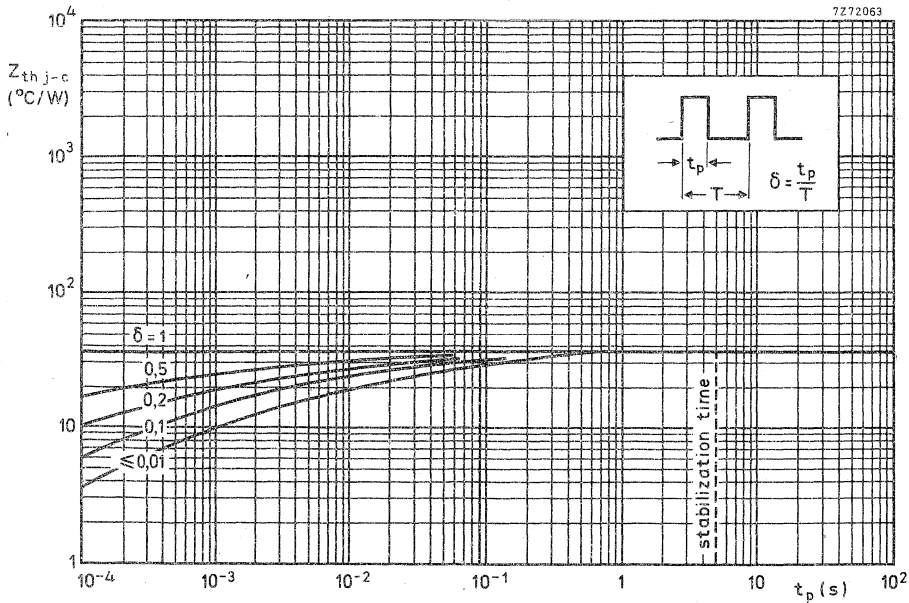

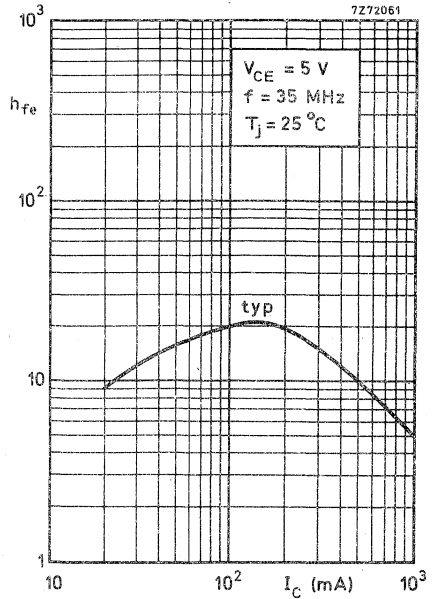
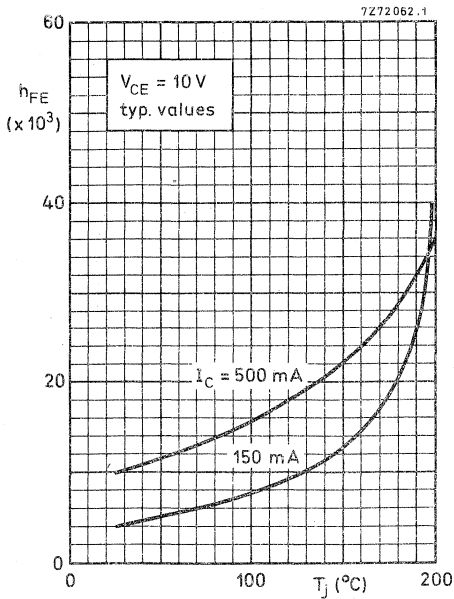
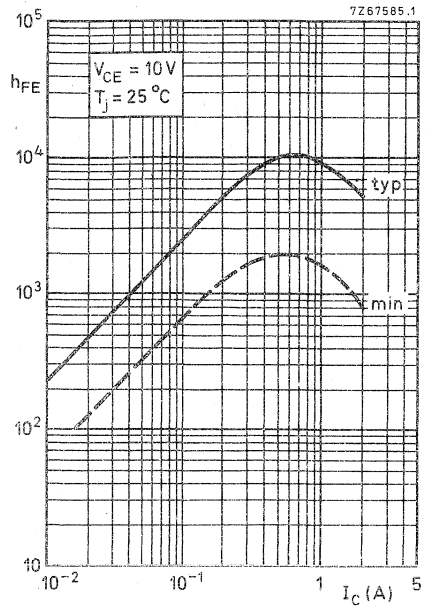
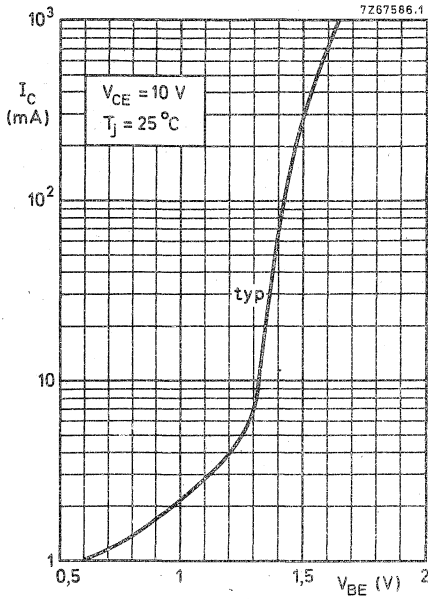

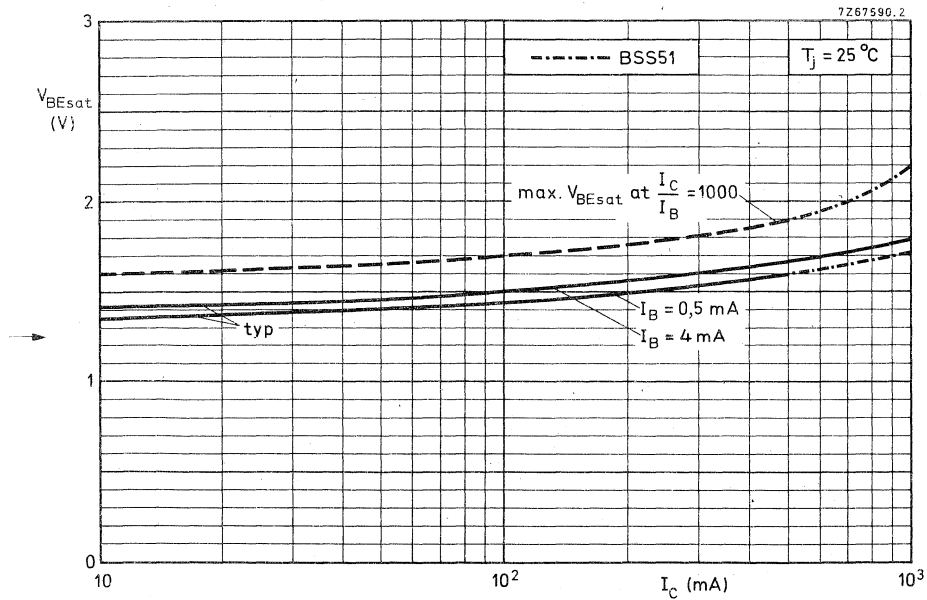
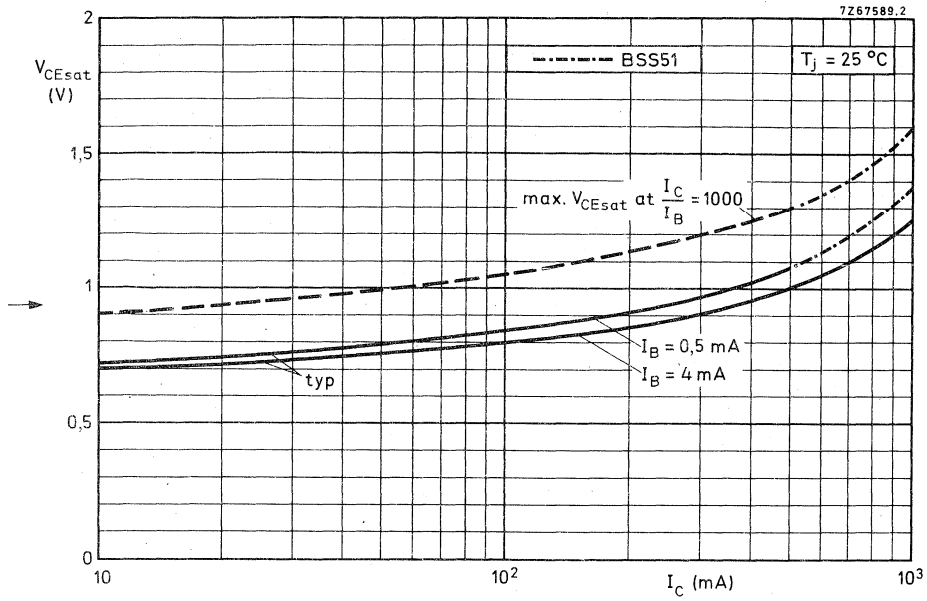

HIGH-VOLTAGE P-N-P TRANSISTOR

Silicon planar epitaxial transistor in a plastic TO-92 variant.
 It is intended for anode switching in dynamically driven numerical indicator tubes and as general purpose switching device.

| QUICK REFERENCE DATA | | | |
|---|------------|------|----------------------|
| Collector-emitter voltage ($R_{BE} = 10 \text{ k}\Omega$) | $-V_{CER}$ | max. | 110 V |
| Collector-emitter voltage (open base) | $-V_{CEO}$ | max. | 100 V |
| Collector current (d. c.) | $-I_C$ | max. | 100 mA |
| Total power dissipation up to $T_{amb} = 25 \text{ }^\circ\text{C}$ | P_{tot} | max. | 500 mW |
| Junction temperature | T_j | max. | 150 $^\circ\text{C}$ |
| D. C. current gain at $T_j = 25 \text{ }^\circ\text{C}$ | h_{FE} | > | 30 |
| $-I_C = 25 \text{ mA}; -V_{CE} = 5 \text{ V}$ | | | |
| Transition frequency at $f = 35 \text{ MHz}$ | f_T | > | 50 MHz |
| $-I_C = 25 \text{ mA}; -V_{CE} = 5 \text{ V}$ | | | |

MECHANICAL DATA

Dimensions in mm

TO-92 variant

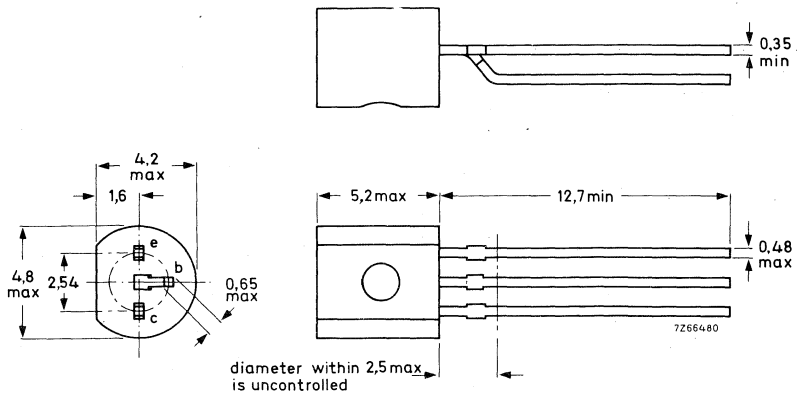

RATINGS Limiting values in accordance with the Absolute Maximum System (IEC 134)

Voltages

| | | | |
|---|------------|------|-------|
| Collector-base voltage (open emitter) | $-V_{CBO}$ | max. | 110 V |
| Collector-emitter voltage ($R_{BE} = 10 \text{ k}\Omega$) | $-V_{CER}$ | max. | 110 V |
| Collector-emitter voltage (open base) | $-V_{CEO}$ | max. | 100 V |
| Emitter-base voltage (open collector) | $-V_{EBO}$ | max. | 6 V |

Current

| | | | |
|---------------------------|--------|------|--------|
| Collector current (d. c.) | $-I_C$ | max. | 100 mA |
|---------------------------|--------|------|--------|

Power dissipation

| | | | |
|---|-----------|------|--------|
| → Total power dissipation up to $T_{amb} = 25 \text{ }^\circ\text{C}$ | P_{tot} | max. | 500 mW |
|---|-----------|------|--------|

Temperatures

| | | | |
|----------------------|-----------|-------------|----------------------|
| Storage temperature | T_{stg} | -65 to +150 | $^\circ\text{C}$ |
| Junction temperature | T_j | max. | 150 $^\circ\text{C}$ |

THERMAL RESISTANCE

| | | | |
|--------------------------------------|----------------------|---|---------------------------------|
| From junction to ambient in free air | $R_{th \text{ j-a}}$ | = | 0,25 $^\circ\text{C}/\text{mW}$ |
|--------------------------------------|----------------------|---|---------------------------------|

CHARACTERISTICS

$T_j = 25 \text{ }^\circ\text{C}$ unless otherwise specified

Collector cut-off current

| | | | |
|---|------------|---|------------------|
| $I_E = 0; -V_{CB} = 100 \text{ V}; T_j = 70 \text{ }^\circ\text{C}$ | $-I_{CBO}$ | < | 10 μA |
|---|------------|---|------------------|

Saturation voltages

| | | | |
|---|--------------|---|--------|
| $-I_C = 25 \text{ mA}; -I_B = 2,5 \text{ mA}$ | $-V_{CEsat}$ | < | 250 mV |
| | $-V_{BEsat}$ | < | 900 mV |

D. C. current gain

| | | | |
|---|----------|---|----|
| $-I_C = 10 \text{ mA}; -V_{CE} = 5 \text{ V}$ | h_{FE} | > | 30 |
| $-I_C = 25 \text{ mA}; -V_{CE} = 5 \text{ V}$ | h_{FE} | > | 30 |

Collector capacitance at $f = 1 \text{ MHz}$

| | | | |
|---|-------|---|------|
| $I_E = I_e = 0; -V_{CB} = 10 \text{ V}$ | C_c | < | 5 pF |
|---|-------|---|------|

Transition frequency at $f = 35 \text{ MHz}$

| | | | |
|---|-------|---|--------|
| $-I_C = 25 \text{ mA}; -V_{CE} = 5 \text{ V}$ | f_T | > | 50 MHz |
|---|-------|---|--------|

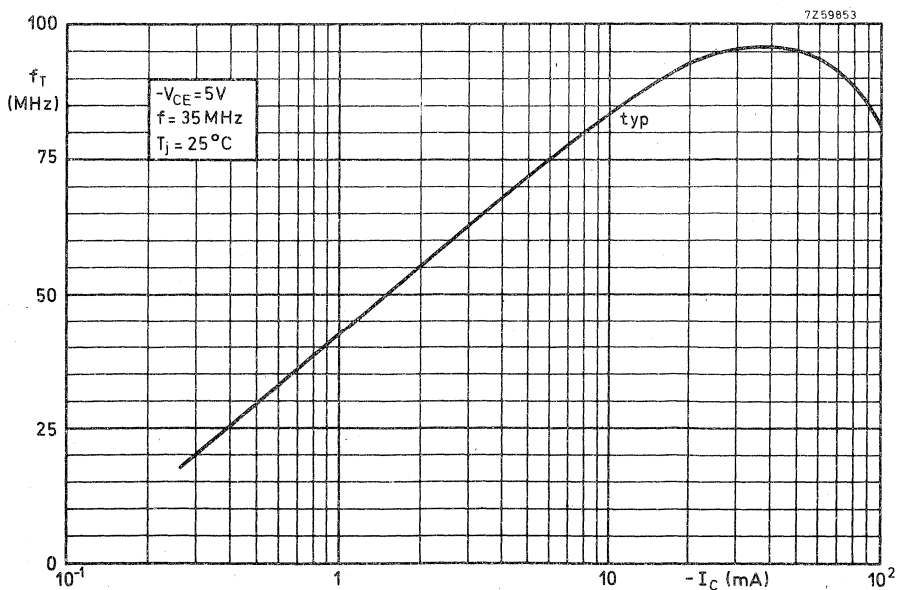
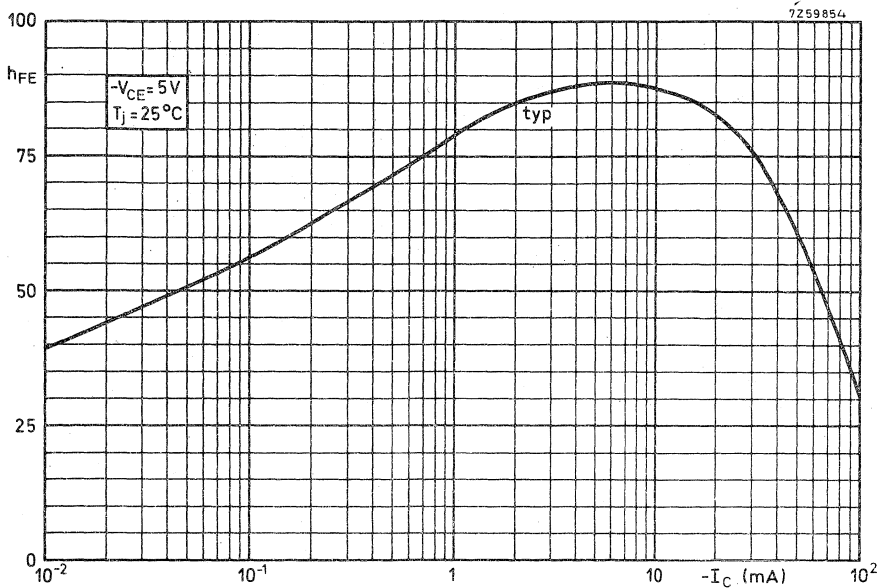

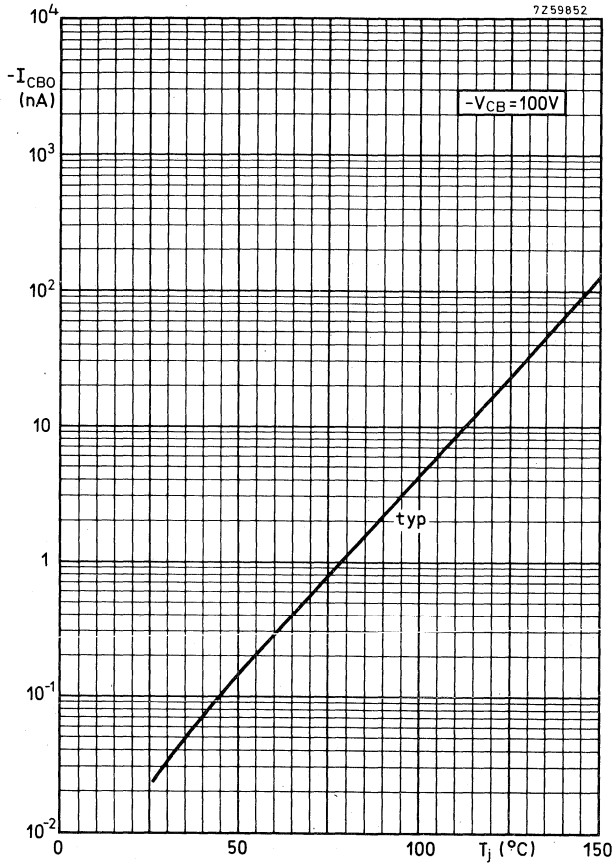

SILICON PLANAR EPITAXIAL TRANSISTORS

P-N-P transistors in a TO-39 metal envelope with the collector connected to the case. These transistors are intended for general industrial applications.

| QUICK REFERENCE DATA | | | | | | |
|---|------------|---|----------|----------|----------|------------------|
| | | BSV15 BSV16 BSV17 | | | | |
| Collector-emitter voltage (open base) | $-V_{CEO}$ | max. | 40 | 60 | 80 | V |
| Collector current (d.c.) | $-I_C$ | max. | 1.0 | | | A |
| Total power dissipation up to $T_{amb} = 25\text{ }^\circ\text{C}$ | P_{tot} | max. | 0.8 | | | W |
| | | up to $T_{case} = 25\text{ }^\circ\text{C}$ | max. | 5.0 | | W |
| Junction temperature | T_j | max. | 200 | | | $^\circ\text{C}$ |
| Transition frequency at $f = 20\text{ MHz}$ | f_T | > | 50 | | | MHz |
| $-I_C = 50\text{ mA}; -V_{CE} = 10\text{ V}$ | | | BSV15-6 | BSV15-10 | BSV15-16 | |
| D.C. current gain | h_{FE} | 40 - 100 | BSV16-6 | BSV16-10 | BSV16-16 | |
| | | | BSV17-6 | BSV17-10 | | |
| | | | | | | 100 - 250 |
| $-I_C = 100\text{ mA}; -V_{CE} = 1\text{ V}$ | | | 63 - 160 | | | |

MECHANICAL DATA

Dimensions in mm

TO-39
Collector connected
to case

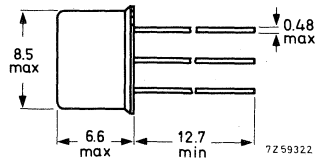
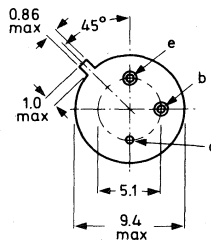

max. lead diameter is guaranteed only for 12.7 mm

Accessories supplied on request: 56218, 56245.

RATINGS Limiting values in accordance with the Absolute Maximum System (IEC134)

Voltages

| | | | BSV15 | BSV16 | BSV17 | |
|--|------------|------|-------|-------|-------|---|
| Collector-emitter voltage (open base) | $-V_{CEO}$ | max. | 40 | 60 | 80 | V |
| Collector-emitter voltage ($V_{BE} = 0$) | $-V_{CES}$ | max. | 40 | 60 | 90 | V |
| Emitter-base voltage (open collector) | $-V_{EBO}$ | max. | 5 | 5 | 5 | V |

Currents

| | | | | | |
|--------------------------|--------|------|-----|--|----|
| Collector current (d.c.) | $-I_C$ | max. | 1.0 | | A |
| Base current (d.c.) | $-I_B$ | max. | 200 | | mA |

Power dissipation

| | | | | | |
|--|-----------|------|-----|--|---|
| Total power dissipation up to $T_{amb} = 25\text{ }^{\circ}\text{C}$ | P_{tot} | max. | 0.8 | | W |
| up to $T_{case} = 25\text{ }^{\circ}\text{C}$ | P_{tot} | max. | 5.0 | | W |
| up to $T_{mb} = 50\text{ }^{\circ}\text{C}$ | P_{tot} | max. | 5.0 | | W |

Temperatures

| | | | | | |
|----------------------|-----------|------|-------------|--|--------------------|
| Storage temperature | T_{stg} | | -65 to +200 | | $^{\circ}\text{C}$ |
| Junction temperature | T_j | max. | 200 | | $^{\circ}\text{C}$ |

THERMAL RESISTANCE

| | | | | | |
|--------------------------------------|----------------|---|-----|--|-----------------------------|
| From junction to ambient in free air | $R_{th\ j-a}$ | = | 220 | | $^{\circ}\text{C}/\text{W}$ |
| From junction to case | $R_{th\ j-c}$ | = | 35 | | $^{\circ}\text{C}/\text{W}$ |
| From junction to mounting base | $R_{th\ j-mb}$ | = | 30 | | $^{\circ}\text{C}/\text{W}$ |

CHARACTERISTICS

$T_{amb} = 25\text{ }^{\circ}\text{C}$ unless otherwise specified

Collector cut-off currents

| | | BSV15 | BSV16 | BSV17 |
|--|------------|-------|-------|------------------|
| $V_{BE} = 0; -V_{CE} = 40\text{ V}$ | $-I_{CES}$ | < 100 | - | - nA |
| $V_{BE} = 0; -V_{CE} = 40\text{ V}; T_{amb} = 150\text{ }^{\circ}\text{C}$ | $-I_{CES}$ | < 50 | - | - μA |
| $V_{BE} = 0; -V_{CE} = 60\text{ V}$ | $-I_{CES}$ | < - | 100 | - nA |
| $V_{BE} = 0; -V_{CE} = 60\text{ V}; T_{amb} = 150\text{ }^{\circ}\text{C}$ | $-I_{CES}$ | < - | 50 | - μA |
| $V_{BE} = 0; -V_{CE} = 80\text{ V}$ | $-I_{CES}$ | < - | - | 100 nA |
| $V_{BE} = 0; -V_{CE} = 80\text{ V}; T_{amb} = 150\text{ }^{\circ}\text{C}$ | $-I_{CES}$ | < - | - | 50 μA |
| $-V_{BE} = 0.2\text{ V}; -V_{CE} = 40\text{ V}; T_{amb} = 100\text{ }^{\circ}\text{C}$ | $-I_{CEX}$ | < 50 | - | - μA |
| $-V_{BE} = 0.2\text{ V}; -V_{CE} = 60\text{ V}; T_{amb} = 100\text{ }^{\circ}\text{C}$ | $-I_{CEX}$ | < - | 50 | - μA |
| $-V_{BE} = 0.2\text{ V}; -V_{CE} = 80\text{ V}; T_{amb} = 100\text{ }^{\circ}\text{C}$ | $-I_{CEX}$ | < - | - | 50 μA |

Emitter cut-off current

| | | | | |
|---------------------------------|------------|------|----|-------|
| $I_C = 0; -V_{EB} = 4\text{ V}$ | $-I_{EBO}$ | < 50 | 50 | 50 nA |
|---------------------------------|------------|------|----|-------|

Breakdown voltages

| | | | | |
|---|----------------|------|----|------|
| $I_B = 0; -I_C = 50\text{ mA}; t_p = 200\text{ }\mu\text{s}; \delta = 0.01$ | $-V_{(BR)CEO}$ | > 40 | 60 | 80 V |
| $V_{BE} = 0; -I_C = 10\text{ }\mu\text{A}$ | $-V_{(BR)CES}$ | > 40 | 60 | 90 V |
| $I_C = 0; -I_E = 10\text{ }\mu\text{A}$ | $-V_{(BR)EBO}$ | > 5 | 5 | 5 V |

Base-emitter voltage

| | | | | |
|--|-----------|------|------------|---|
| $-I_C = 100\text{ mA}; -V_{CE} = 1\text{ V}$ | $-V_{BE}$ | < | 1.0 | V |
| $-I_C = 500\text{ mA}; -V_{CE} = 1\text{ V}$ | $-V_{BE}$ | typ. | 0.85 | V |
| | | | 0.7 to 1.4 | V |

Saturation voltage

| | | | | |
|---|--------------|--|-------------|---|
| $-I_C = 500\text{ mA}; -I_B = 25\text{ mA}$ | $-V_{CEsat}$ | | 0.25 to 1.0 | V |
|---|--------------|--|-------------|---|

Collector capacitance at $f = 1\text{ MHz}$

| | | | | | |
|--|---------------------|-------|------|----|----|
| $I_E = I_e = 0; -V_{CB} = 10\text{ V}$ | <u>BSV15; BSV16</u> | C_c | typ. | 20 | pF |
| | | | < | 30 | pF |
| $I_E = I_e = 0; -V_{CB} = 10\text{ V}$ | <u>BSV17</u> | C_c | typ. | 15 | pF |
| | | | < | 25 | pF |

Emitter capacitance at $f = 1\text{ MHz}$

| | | | | |
|---|-------|------|-----|----|
| $I_C = I_c = 0; -V_{EB} = 0.5\text{ V}$ | C_e | typ. | 180 | pF |
|---|-------|------|-----|----|

Transition frequency at $f = 20\text{ MHz}$

| | | | | |
|--|-------|---|----|-----|
| $-I_C = 50\text{ mA}; -V_{CE} = 10\text{ V}$ | f_T | > | 50 | MHz |
|--|-------|---|----|-----|

CHARACTERISTICS (continued)

$T_{amb} = 25\text{ }^{\circ}\text{C}$ unless otherwise specified

D.C. current gain

$-I_C = 0.1\text{ mA}; -V_{CE} = 1\text{ V}$

| | BSV15-6 | BSV15-10 | BSV15-16 |
|----------|---------|----------|----------|
| h_{FE} | > 15 | 20 | 30 |
| typ. | 44 | 75 | 120 |

$-I_C = 100\text{ mA}; -V_{CE} = 1\text{ V}$

| | BSV16-6 | BSV16-10 | BSV16-16 |
|----------|-----------|-----------|------------|
| h_{FE} | typ. 63 | 100 | 160 |
| | 40 to 100 | 63 to 160 | 100 to 250 |

$-I_C = 500\text{ mA}; -V_{CE} = 1\text{ V}$

| | BSV17-6 | BSV17-10 | |
|----------|---------|----------|----|
| h_{FE} | > 20 | 25 | 35 |
| typ. | 40 | 55 | 85 |

h parameter at $f = 1\text{ kHz}$

$-I_C = 1\text{ mA}; -V_{CE} = 5\text{ V}$

Small signal current gain

| | | |
|----------|---|----|
| h_{fe} | > | 20 |
|----------|---|----|

Switching times

Turn-on time

$-I_C = 100\text{ mA}; -I_B = +I_{BM} = 5\text{ mA}$

| | | | |
|----------|---|-----|----|
| t_{on} | < | 500 | ns |
|----------|---|-----|----|

Turn-off time

$-I_C = 100\text{ mA}; -I_B = +I_{BM} = 5\text{ mA}$

Storage time

| | | | |
|-------|---|-----|----|
| t_s | < | 500 | ns |
|-------|---|-----|----|

Fall time

| | | | |
|-------|---|-----|----|
| t_f | < | 150 | ns |
|-------|---|-----|----|

Test circuit:

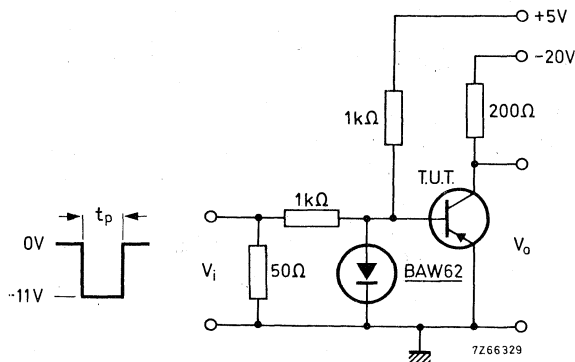

Pulse generator:

| | |
|------------------|----------------------------------|
| Pulse duration | $t_p \geq 10\text{ }\mu\text{s}$ |
| Rise time | $t_r \leq 15\text{ ns}$ |
| Fall time | $t_f \leq 15\text{ ns}$ |
| Source impedance | $R_S = 50\text{ }\Omega$ |

Oscilloscope:

| | |
|-----------------|---------------------------|
| Rise time | $\leq 15\text{ ns}$ |
| Input impedance | $\geq 100\text{ k}\Omega$ |

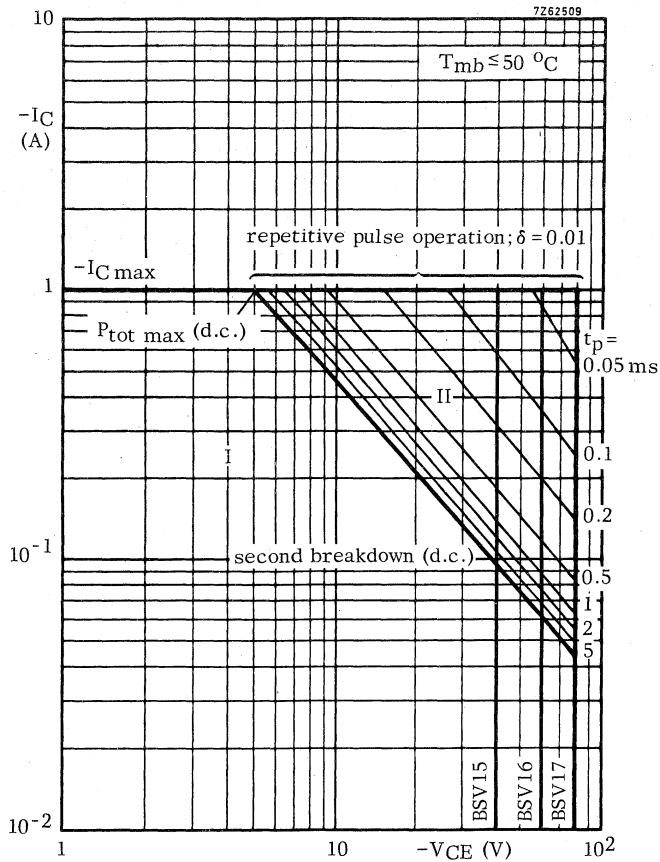

Safe Operating Area with the transistor forward biased

- I Region of permissible d. c. operation
- II Permissible extension for repetitive pulse operation

7262508

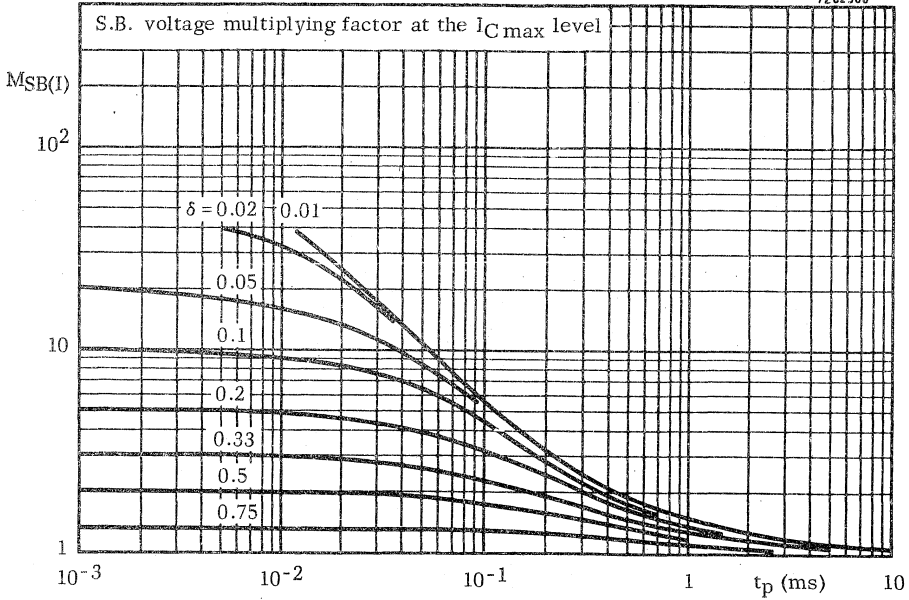

7262507

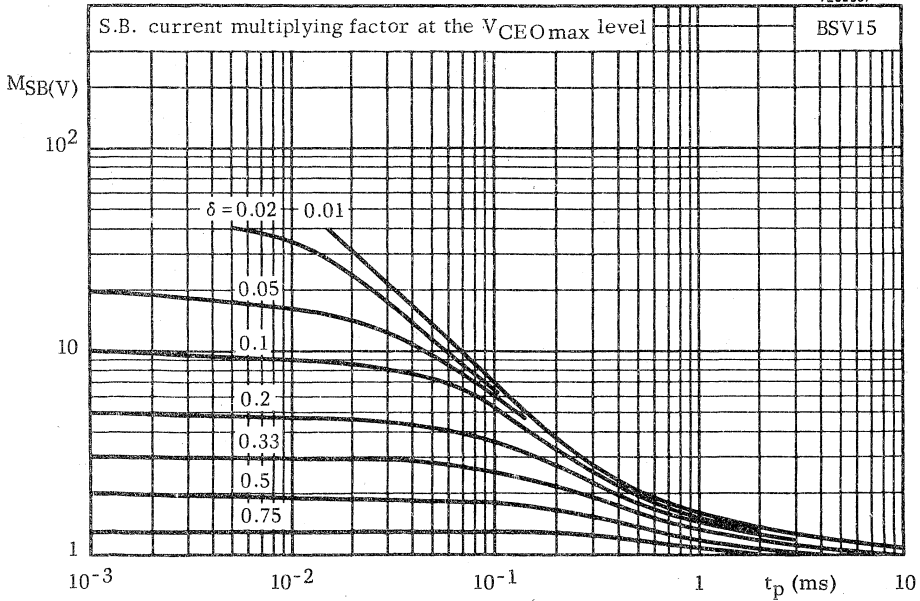

BSV15

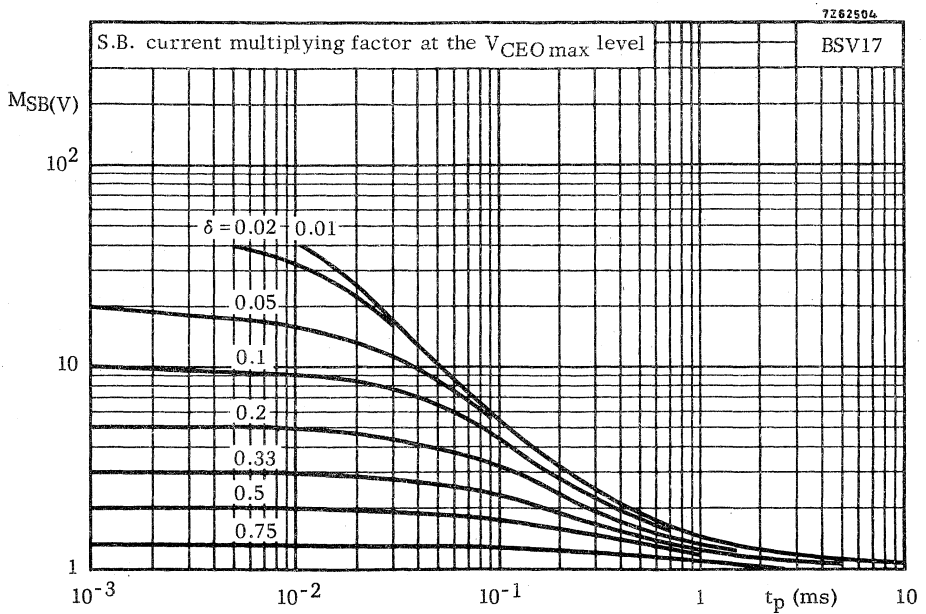
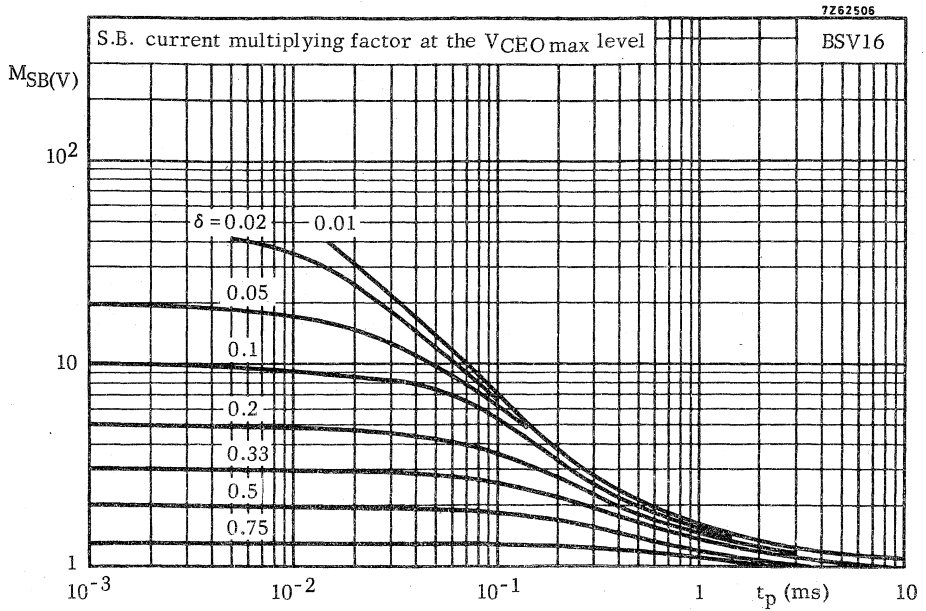

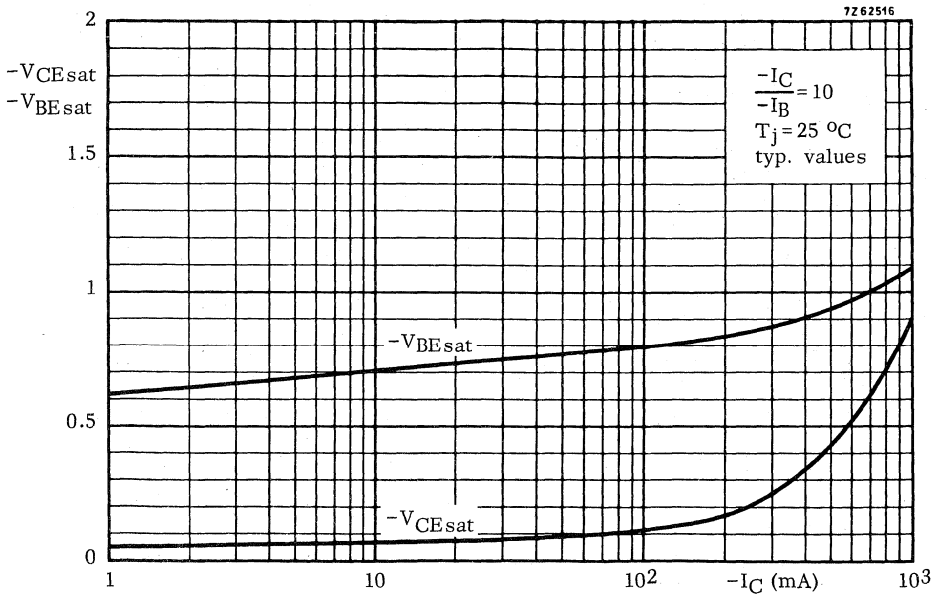
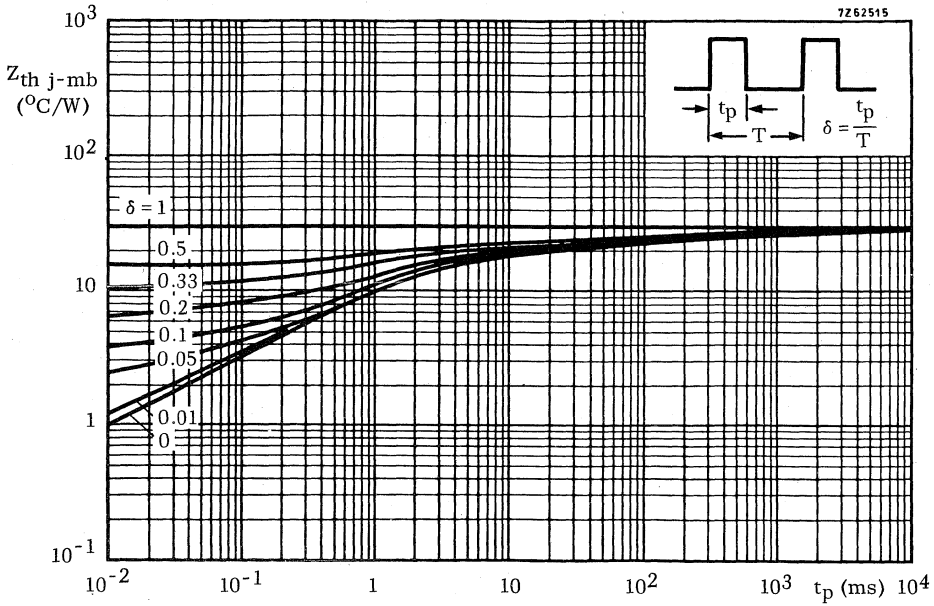

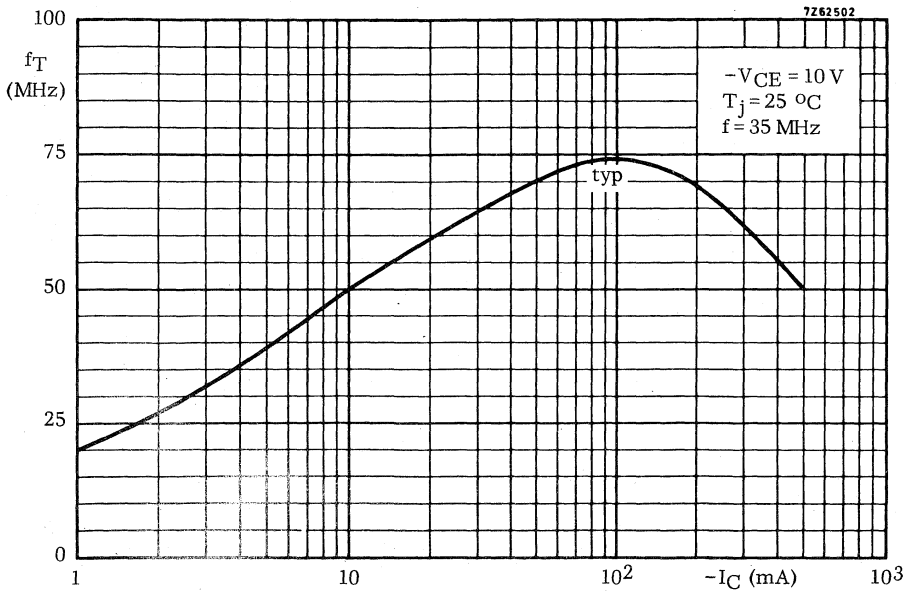
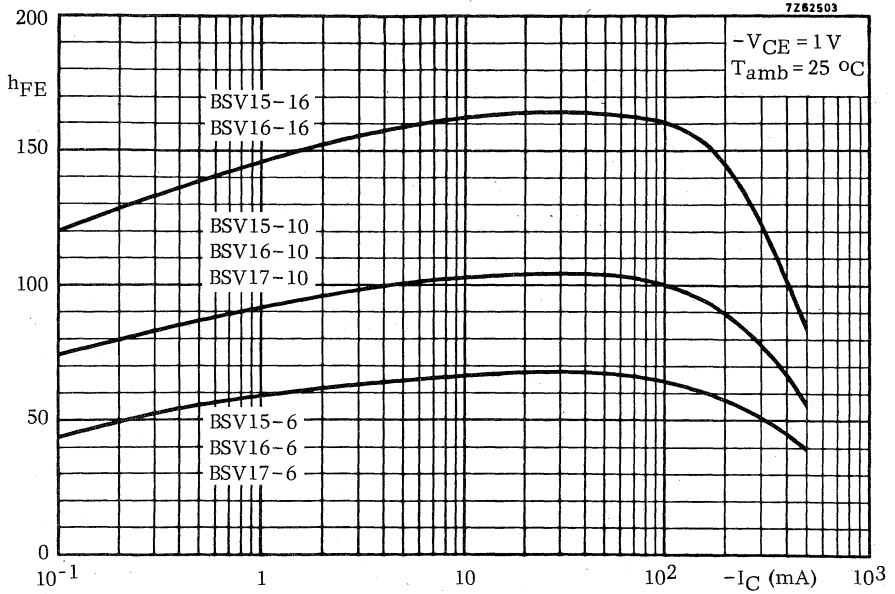

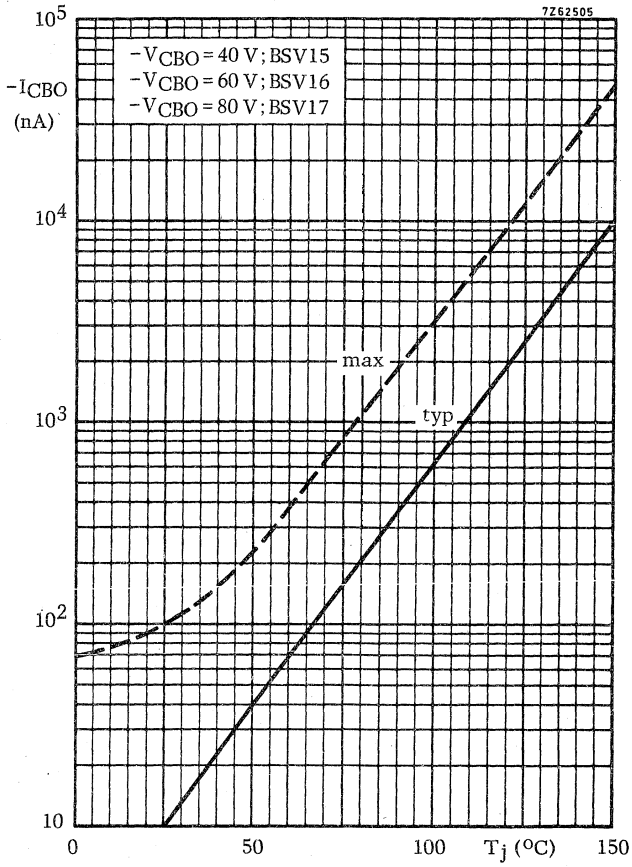

000000
000000
000000
000000
000000
000000

SILICON PLANAR EPITAXIAL TRANSISTOR

N-P-N transistor in a TO-39 metal envelope primarily intended for use as a print hammer drive. It has good high current saturation characteristics.

| QUICK REFERENCE DATA | | |
|--|-----------|-----------------------------|
| Collector-base voltage (open emitter) | V_{CBO} | max. 100 V |
| Collector-emitter voltage (open base) | V_{CEO} | max. 60 V |
| Collector current (peak value) | I_{CM} | max. 5.0 A |
| Total power dissipation up to $T_{case} = 50\text{ }^{\circ}\text{C}$ | P_{tot} | max. 5.0 W |
| Junction temperature | T_j | max. 175 $^{\circ}\text{C}$ |
| D.C. current gain $I_C = 2\text{ A}; V_{CE} = 2\text{ V}$ | h_{FE} | > 40 |
| Transition frequency at $f = 35\text{ MHz}$ $I_C = 0.5\text{ A}; V_{CE} = 5\text{ V}$ | f_T | typ. 100 MHz |
| Turn off time when switched from $I_C = 5\text{ A}; I_B = 0.5\text{ A}$ to cut-off with $-I_{BM} = 0.5\text{ A}$ | t_{off} | < 1.2 μs |

MECHANICAL DATA

Dimensions in mm

Collector connected to case

TO-39

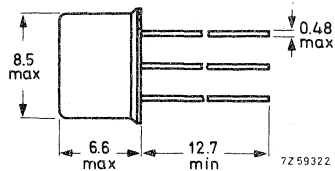
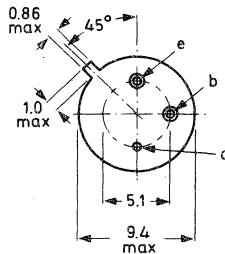

max. lead diameter is guaranteed only for 12.7 mm

Accessories supplied on request: 56218; 56245

RATINGS Limiting values in accordance with the Absolute Maximum System (IEC 134)Voltages

| | | | | |
|---|-----------|------|-----|---|
| Collector-base voltage (open emitter) | V_{CBO} | max. | 100 | V |
| Collector-emitter voltage ($R_{BE} \leq 50 \Omega$) | V_{CER} | max. | 80 | V |
| Collector-emitter voltage (open base) | V_{CEO} | max. | 60 | V |
| Emitter-base voltage (open collector) | V_{EBO} | max. | 5 | V |

Currents

| | | | | |
|--------------------------------|----------|------|-----|---|
| Collector current (d. c.) | I_C | max. | 2,0 | A |
| Collector current (peak value) | I_{CM} | max. | 5,0 | A |
| Base current (d. c.) | I_B | max. | 1,0 | A |

Power dissipation

| | | | | |
|--|-----------|------|-----|---|
| Total power dissipation up to $T_{case} = 50 \text{ }^\circ\text{C}$ | P_{tot} | max. | 5,0 | W |
|--|-----------|------|-----|---|

Temperatures

| | | | |
|----------------------|-----------|-------------|------------------|
| Storage temperature | T_{stg} | -55 to +175 | $^\circ\text{C}$ |
| Junction temperature | T_j | max. 175 | $^\circ\text{C}$ |

THERMAL RESISTANCE

| | | | | |
|-----------------------|----------------------|---|----|--------------------|
| From junction to case | $R_{th \text{ j-c}}$ | = | 25 | $^\circ\text{C/W}$ |
|-----------------------|----------------------|---|----|--------------------|

CHARACTERISTICS

$T_j = 25^\circ\text{C}$ unless otherwise specified

Collector cut-off current

$I_E = 0; V_{CB} = 60\text{ V}$ $I_{CBO} < 10\ \mu\text{A}$

Emitter cut-off current

$I_C = 0; V_{EB} = 4\text{ V}$ $I_{EBO} < 10\ \mu\text{A}$

Saturation voltages

$I_C = 5\text{ A}; I_B = 0.5\text{ A}$ $V_{CEsat} < 1.0\text{ V}$
 $V_{BEsat} < 1.8\text{ V}$

D.C. current gain

$I_C = 2\text{ A}; V_{CE} = 2\text{ V}$ $h_{FE} > 40$

Collector capacitance at $f = 1\text{ MHz}$

$I_E = I_e = 0; V_{CB} = 10\text{ V}$ $C_c < 80\text{ pF}$

Transition frequency at $f = 35\text{ MHz}$

$I_C = 0.5\text{ A}; V_{CE} = 5\text{ V}$ $f_T \text{ typ. } 100\text{ MHz}$

Turn on time when switched from

$-V_{BE} = 2.0\text{ V}$ to $I_C = 5\text{ A}; I_B = 0.5\text{ A}$
 with $I_{BM} = 0.5\text{ A}$ $t_{on} < 0.6\ \mu\text{s}$

Turn off time when switched from

$I_C = 5\text{ A}; I_B = 0.5\text{ A}$ to $-V_{BE} = 2.0\text{ V}$
 with $-I_{BM} = 0.5\text{ A}$ $t_{off} < 1.2\ \mu\text{s}$



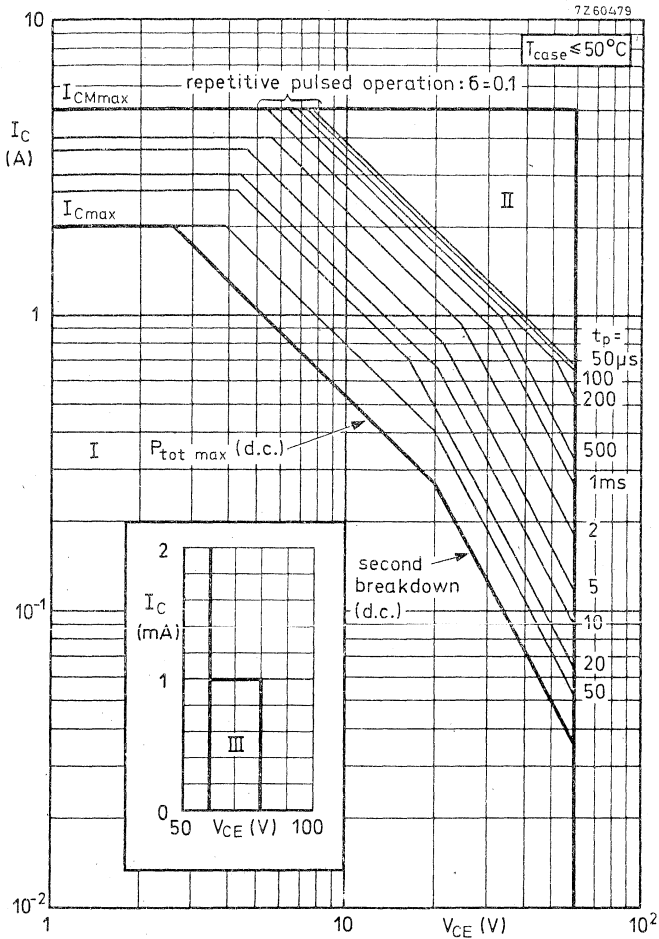

Safe Operating Area

- I Region of permissible d.c. operation
- II Permissible extension for repetitive pulsed operation
- III D.C. operation in this region is allowable, provided $R_{BE} \leq 50 \Omega$

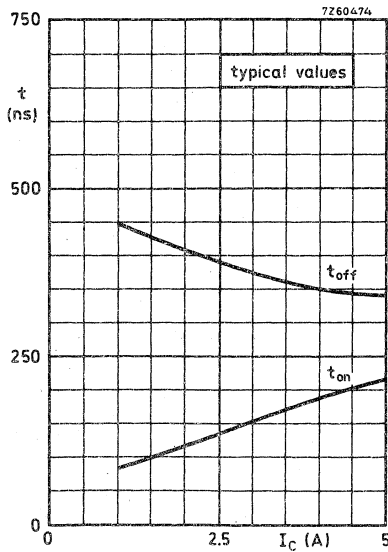
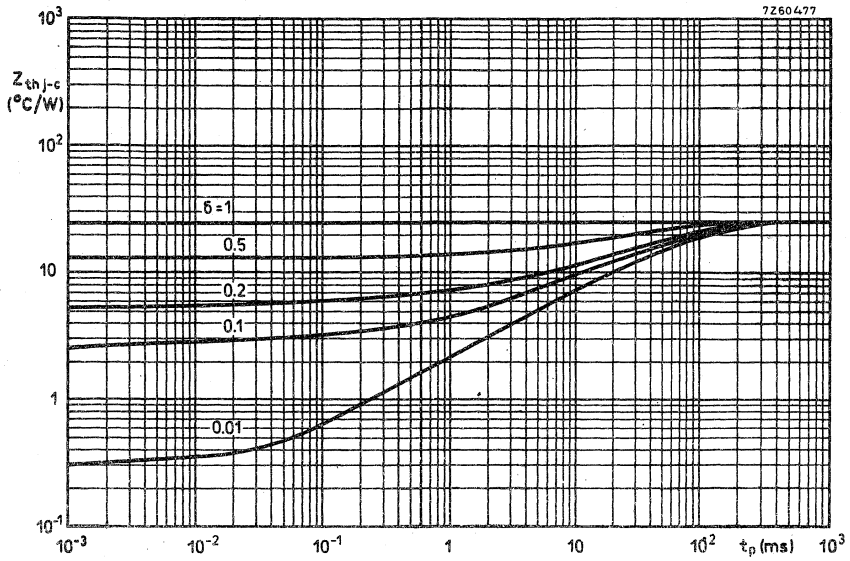

BSV64

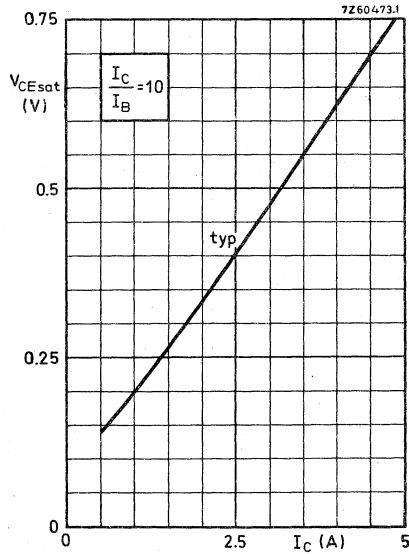
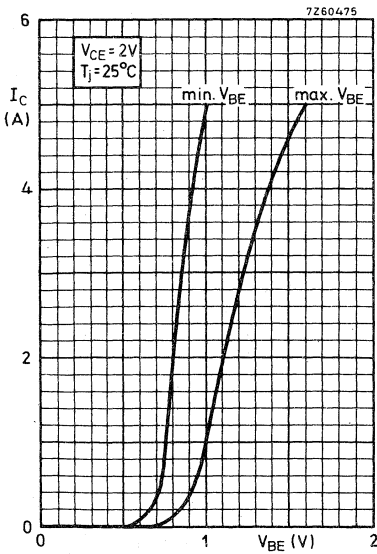
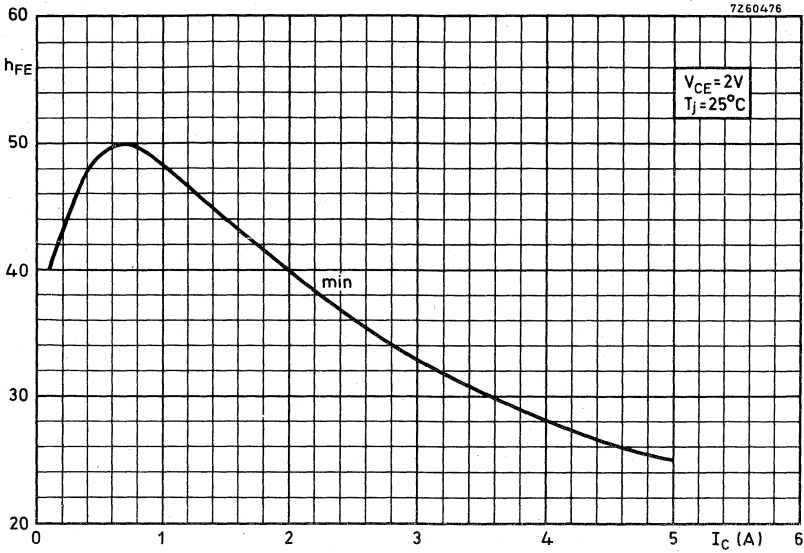

SILICON PLANAR EPITAXIAL TRANSISTOR

N-P-N transistor in a TO-18 metal envelope intended for core driver applications in small memories.

| QUICK REFERENCE DATA | | | |
|---|-----------|------|------------------------|
| Collector-base voltage (open emitter) | V_{CBO} | max. | 40 V |
| Collector-emitter voltage (open base) | V_{CEO} | max. | 25 V |
| Collector current (peak value) | I_{CM} | max. | 500 mA |
| Total power dissipation up to $T_{case} = 25\text{ }^{\circ}\text{C}$ | P_{tot} | max. | 1,0 W |
| Junction temperature | T_j | max. | 200 $^{\circ}\text{C}$ |
| D.C. current gain $I_C = 500\text{ mA}; V_{CE} = 1\text{ V}$ | h_{FE} | > | 15 |
| Transition frequency $I_C = 50\text{ mA}; V_{CE} = 10\text{ V}; f = 100\text{ MHz}$ | f_T | > | 250 MHz |
| Turn-off time when switched from $I_C = 500\text{ mA}; I_B = 50\text{ mA}$ to cut-off with $-I_{BM} = 50\text{ mA}$ | t_{off} | < | 60 ns |

MECHANICAL DATA

Dimensions in mm

Collector connected to case

TO-18

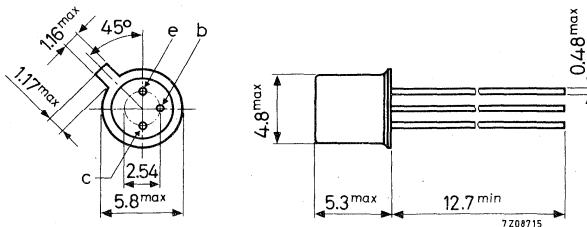

Accessories supplied on request: 56246; 56263

RATINGS Limiting values in accordance with the Absolute Maximum System (IEC134)Voltages

Collector-base voltage (open emitter)

$I_C = 0, 1 \text{ mA}$

$V_{CBO} \quad \text{max.} \quad 40 \text{ V}$

Collector-emitter voltage (open base)

$I_C = 30 \text{ mA}$

$V_{CEO} \quad \text{max.} \quad 25 \text{ V}$

Emitter-base voltage (open collector)

$I_E = 0, 1 \text{ mA}$

$V_{EBO} \quad \text{max.} \quad 5 \text{ V}$

Currents

Collector current (d.c.)

$I_C \quad \text{max.} \quad 300 \text{ mA}$

Collector current (peak value)

$I_{CM} \quad \text{max.} \quad 500 \text{ mA}$

Power dissipationTotal power dissipation up to $T_{\text{case}} = 25 \text{ }^\circ\text{C}$

$P_{\text{tot}} \quad \text{max.} \quad 1, 0 \text{ W}$

Temperatures

Storage temperature

$T_{\text{stg}} \quad -65 \text{ to } +200 \text{ }^\circ\text{C}$

Junction temperature

$T_j \quad \text{max.} \quad 200 \text{ }^\circ\text{C}$

THERMAL RESISTANCE

From junction to ambient in free air

$R_{\text{th j-a}} = 0, 50 \text{ }^\circ\text{C/mW}$

From junction to case

$R_{\text{th j-c}} = 0, 175 \text{ }^\circ\text{C/mW}$

CHARACTERISTICS $T_j = 25\text{ }^\circ\text{C}$ unless otherwise specifiedCollector cut-off current

| | | | | |
|--|-----------|---|-----|---------------|
| $I_E = 0; V_{CB} = 30\text{ V}$ | I_{CBO} | < | 0,5 | μA |
| $I_E = 0; V_{CB} = 30\text{ V}; T_j = 100\text{ }^\circ\text{C}$ | I_{CBO} | < | 50 | μA |

Breakdown voltages

| | | | | |
|---|---------------|---|----|---|
| $I_C = 30\text{ mA}; R_{BE} = 100\ \Omega$ | $V_{(BR)CER}$ | > | 40 | V |
| $I_C = 30\text{ mA}; R_{BE} = 1\text{ k}\Omega$ | $V_{(BR)CER}$ | > | 30 | V |

Saturation voltages

| | | | | |
|---|-------------|---|-----|---|
| $I_C = 150\text{ mA}; I_B = 15\text{ mA}$ | V_{CEsat} | < | 0,5 | V |
| | V_{BEsat} | < | 1,3 | V |
| $I_C = 500\text{ mA}; I_B = 35\text{ mA}$ | V_{CEsat} | < | 0,7 | V |
| $I_C = 500\text{ mA}; I_B = 50\text{ mA}$ | V_{BEsat} | < | 1,8 | V |

D.C. current gain

| | | | |
|--|----------|---|----|
| $I_C = 10\text{ mA}; V_{CE} = 10\text{ V}$ | h_{FE} | > | 30 |
| $I_C = 150\text{ mA}; V_{CE} = 1\text{ V}$ | h_{FE} | > | 40 |
| $I_C = 500\text{ mA}; V_{CE} = 1\text{ V}$ | h_{FE} | > | 15 |

Collector capacitance at $f = 1\text{ MHz}$

| | | | | |
|---------------------------------------|-------|---|-----|----|
| $I_E = I_e = 0; V_{CB} = 10\text{ V}$ | C_c | < | 8,0 | pF |
|---------------------------------------|-------|---|-----|----|

Transition frequency at $f = 100\text{ MHz}$

| | | | | |
|--|-------|---|-----|-----|
| $I_C = 50\text{ mA}; V_{CE} = 10\text{ V}$ | f_T | > | 250 | MHz |
|--|-------|---|-----|-----|

Turn-on time when switched to

| | | | | |
|---|----------|---|----|----|
| a) $I_C = 150\text{ mA}; I_B = 15\text{ mA}$ (Fig. 1 on page 4) | t_{on} | < | 60 | ns |
| b) $I_C = 300\text{ mA}; I_B = 40\text{ mA}$ (Fig. 1 on page 4) | t_{on} | < | 50 | ns |

Turn-off time when switched from

| | | | | |
|--|-----------|---|-----|----|
| c) $I_C = 150\text{ mA}; I_B = 15\text{ mA}$ to cut-off with $-I_{BM} = 15\text{ mA}$ (Fig. 2 on page 4) | t_{off} | < | 70 | ns |
| d) $I_C = 300\text{ mA}; I_B = 40\text{ mA}$ to cut-off with $-I_{BM} = 20\text{ mA}$ (Fig. 1 on page 4) | t_{off} | < | 110 | ns |
| e) $I_C = 400\text{ mA}; I_B = 50\text{ mA}$ to cut-off with $-I_{BM} = 1\text{ mA}$ (Fig. 1 on page 4) | t_{off} | < | 300 | ns |
| f) $I_C = 500\text{ mA}; I_B = 50\text{ mA}$ to cut-off with $-I_{BM} = 50\text{ mA}$ (Fig. 3 on page 4) | t_{off} | < | 60 | ns |

CHARACTERISTICS (continued)

| | I_C (mA) | I_B (mA) | I_{BM} (mA) | V_{CC} (V) | R_1 (k Ω) | R_2 (k Ω) | R_3 (Ω) | R_4 (Ω) | V_{BB} (V) | V_{BE} (V) | V_i (V) |
|---|---------------|---------------|------------------|-----------------|------------------------|------------------------|-----------------------|-----------------------|-----------------|-----------------|---------------|
| a | 150 | 15 | - | 10 | 1 | ∞ | 50 | 62 | - | - | 0 to +16 |
| b | 300 | 40 | - | 15,5 | 0,33 | 0,33 | 56 | 50 | -4,5 | -2,25 | 0 to +20 |
| c | 150 | 15 | -15 | 10 | 1 | 1 | 50 | 62 | +16 | - | 0 to -30 |
| d | 300 | 40 | -20 | 15,5 | 0,33 | 0,33 | 56 | 50 | +15,3 | - | 0 to -20 |
| e | 400 | 50 | -1 | 12,5 | 1 | ∞ | 50 | 30 | - | - | +51 to 0 |
| f | 500 | 50 | -50 | 21 | 0,2 | - | - | 40 | -3 | - | +11,3 to -8,7 |

Test circuits:

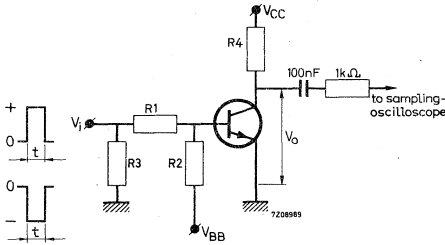

Fig. 1

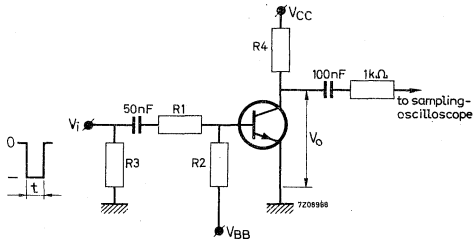

Fig. 2

Pulse generator:

Rise time $t_r \leq 2$ ns
 Pulse duration $t \approx 200$ ns
 Fall time $t_f \leq 2$ ns
 Output resistance $R_o = 50 \Omega$

Oscilloscope:

Input resistance $R_i = 50 \Omega$

Equivalent test circuit:

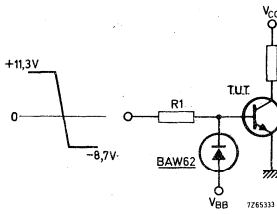
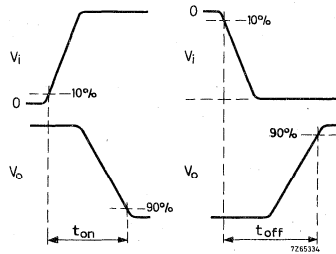
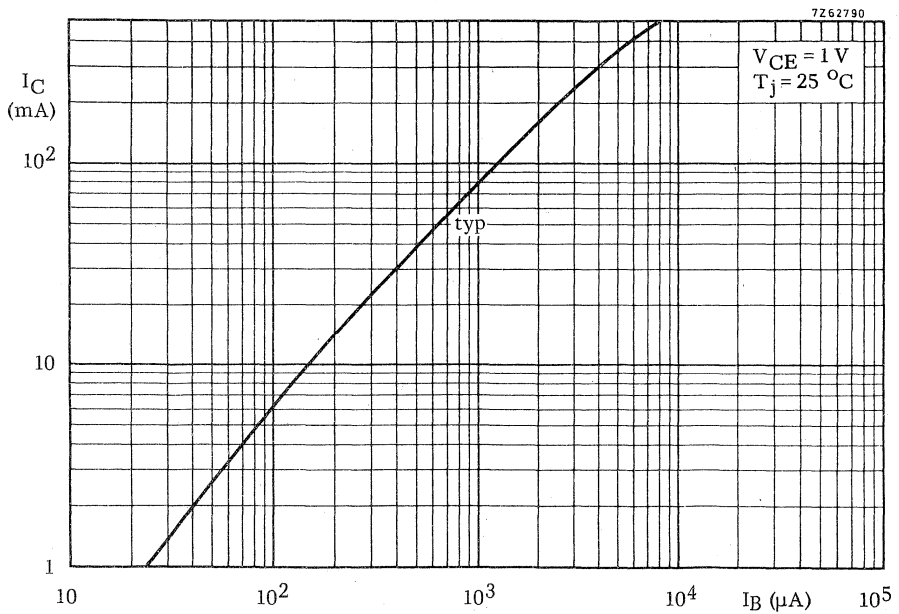
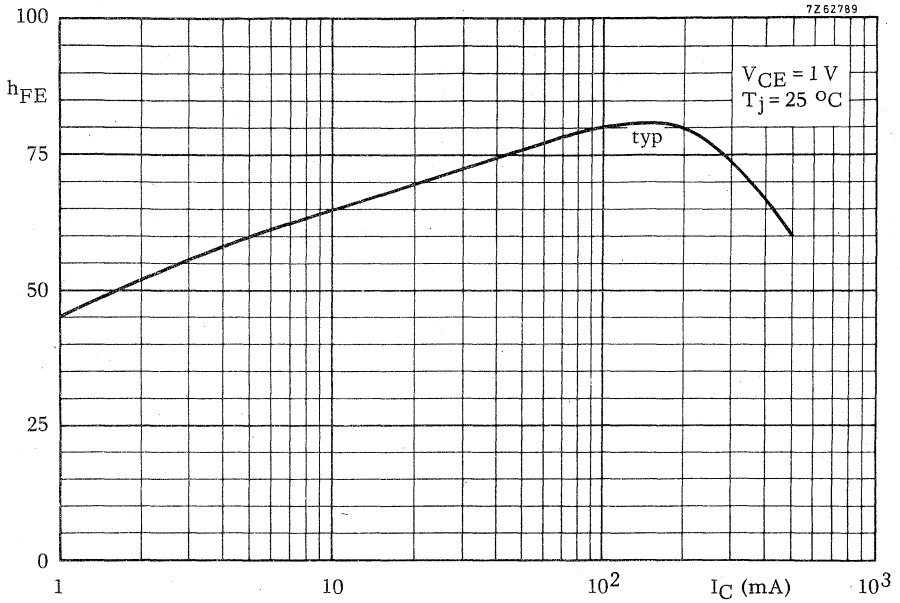
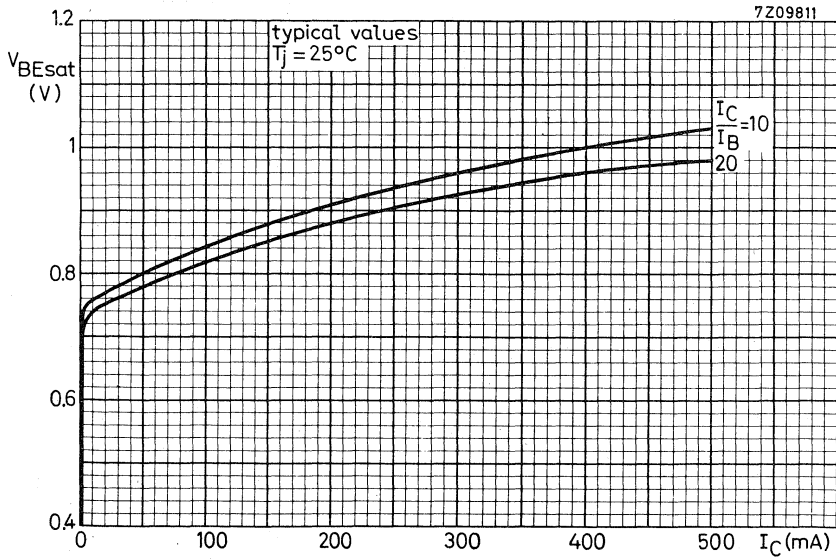
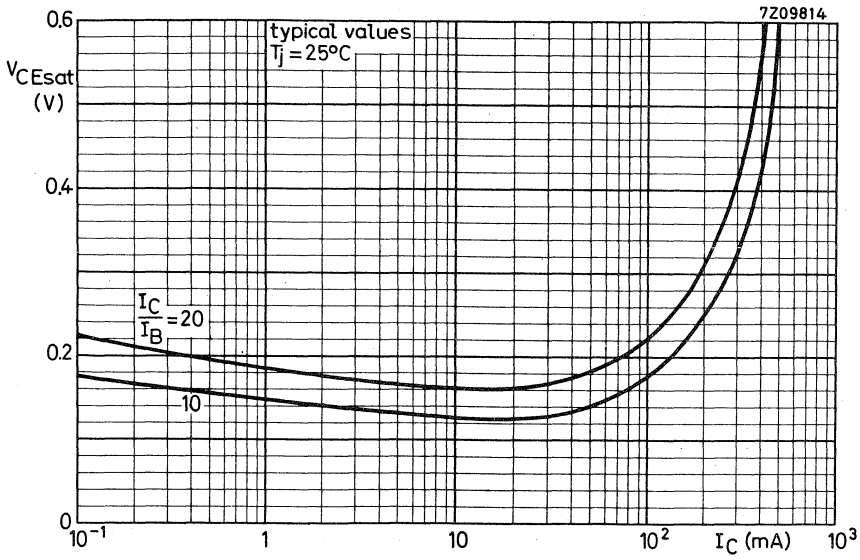
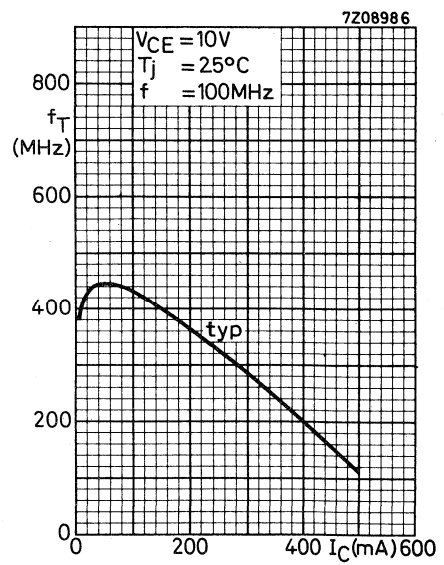
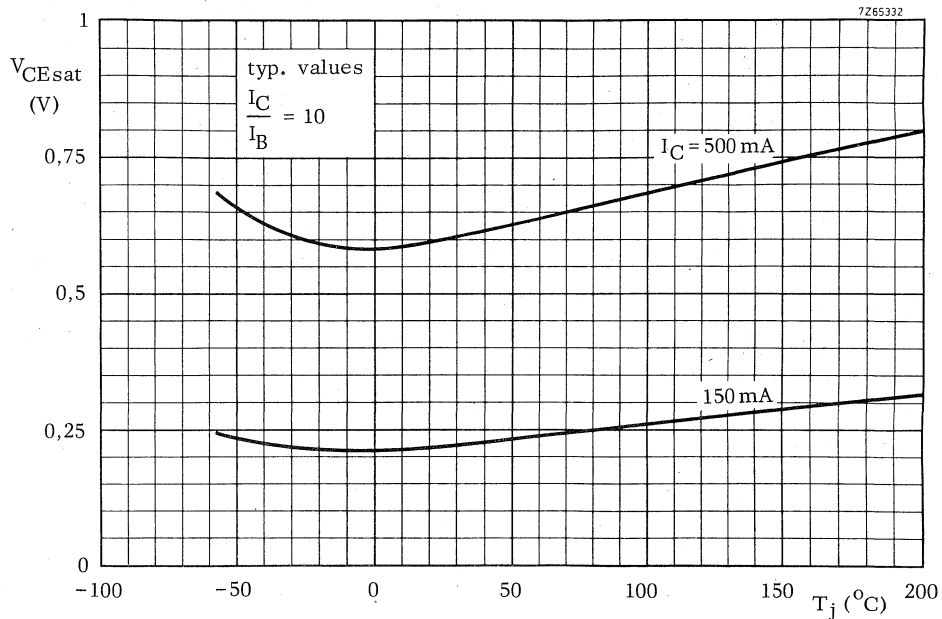

Fig. 3









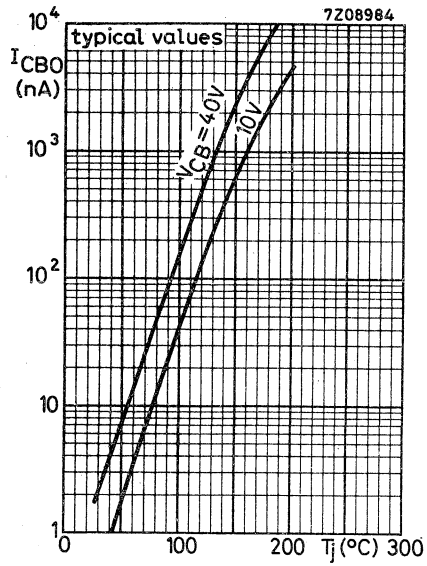
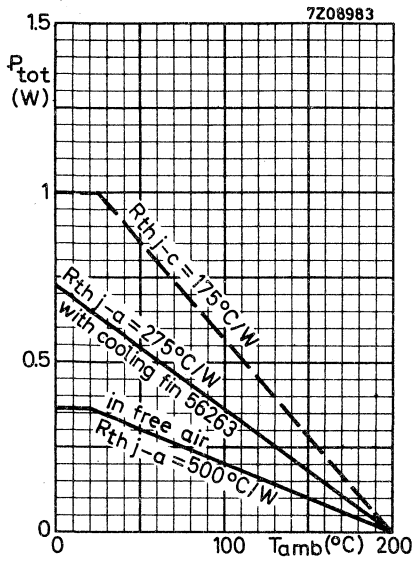

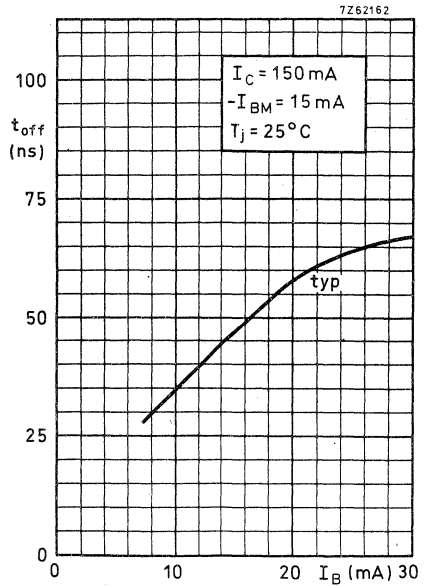
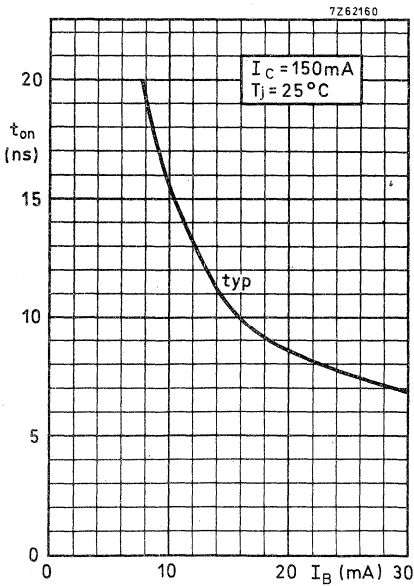
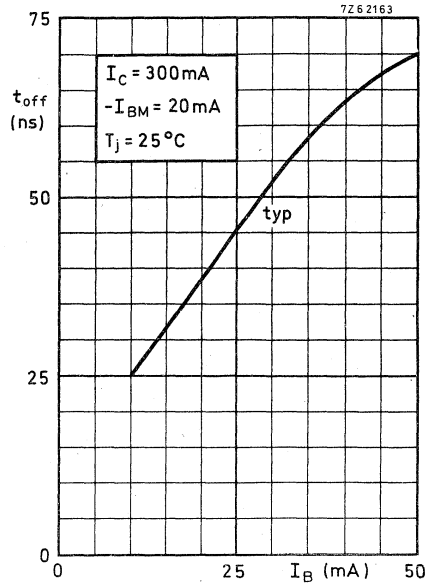
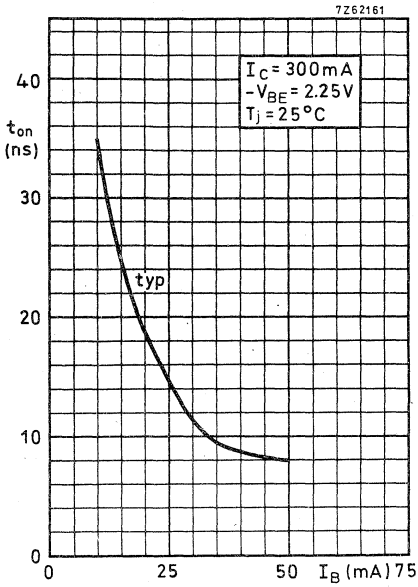

SILICON PLANAR EPITAXIAL TRANSISTORS

N-P-N transistors in TO-39 metal envelopes with the collector connected to the case. They are primarily intended for switching with inductive load and for general purposes.

| QUICK REFERENCE DATA | | | BSW66 | BSW67 | BSW68 |
|---|-----------|------|------------------------|-------|-------|
| Collector-base voltage (open emitter) | V_{CBO} | max. | 100 | 120 | 150 V |
| Collector-emitter voltage (open base) | V_{CEO} | max. | 100 | 120 | 150 V |
| Emitter-base voltage (open collector) | V_{EBO} | max. | 6 | 6 | 6 V |
| Collector current (peak value) | I_{CM} | max. | 2 A | | |
| Total power dissipation up to $T_{case} = 25\text{ }^{\circ}\text{C}$ | P_{tot} | max. | 5,0 W | | |
| Junction temperature | T_j | max. | 200 $^{\circ}\text{C}$ | | |
| Transition frequency at $f = 35\text{ MHz}$ $I_C = 100\text{ mA}$; $V_{CE} = 20\text{ V}$ | f_T | typ. | 80 MHz | | |
| D. C. current gain | | | | | |
| $I_C = 10\text{ mA}$; $V_{CE} = 5\text{ V}$ | h_{FE} | > | 30 | | |
| $I_C = 500\text{ mA}$; $V_{CE} = 5\text{ V}$ | h_{FE} | > | 30 | | |

MECHANICAL DATA

Dimensions in mm

Collector connected to case

TO-39

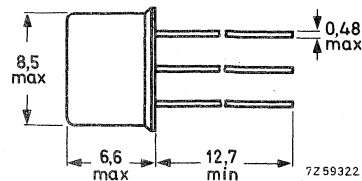
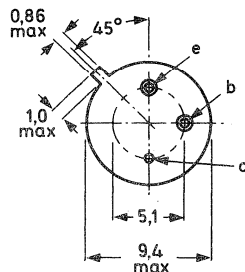

Accessories: 56218 (package); 56245 (distance disc).

RATINGS Limiting values in accordance with the Absolute Maximum System (IEC134)

| <u>Voltages</u> | | BSW66 | BSW67 | BSW68 |
|---|-----------|----------|-------|-------|
| Collector-base voltage (open emitter) | V_{CBO} | max. 100 | 120 | 150 V |
| Collector-emitter voltage (open base) ¹⁾ | V_{CEO} | max. 100 | 120 | 150 V |
| Emitter-base voltage (open collector) | V_{EBO} | max. 6 | 6 | 6 V |

Currents

| | | | |
|---|-----------|------|-----|
| Collector current (d.c. or average over any 20 ms period) | I_C | max. | 1 A |
| Collector current (peak value) | I_{CM} | max. | 2 A |
| Emitter current (peak value) | $-I_{EM}$ | max. | 2 A |

Power dissipation

| | | | |
|---|-----------|------|-------|
| Total power dissipation up to $T_{amb} = 25\text{ }^\circ\text{C}$ $T_{case} = 25\text{ }^\circ\text{C}$ | P_{tot} | max. | 0.8 W |
| | P_{tot} | max. | 5.0 W |

Switch off energy with inductive load

| | | | |
|--------------------------|-----|------|-------|
| $I_C \leq 500\text{ mA}$ | E | max. | 5 mWs |
|--------------------------|-----|------|-------|

Temperatures

| | | | |
|----------------------|-----------|-------------|------------------|
| Storage temperature | T_{stg} | -65 to +200 | $^\circ\text{C}$ |
| Junction temperature | T_j | max. 200 | $^\circ\text{C}$ |

THERMAL RESISTANCE

| | | | |
|--------------------------------------|---------------|---|------------------------|
| From junction to ambient in free air | $R_{th\ j-a}$ | = | 220 $^\circ\text{C/W}$ |
| From junction to case | $R_{th\ j-c}$ | = | 35 $^\circ\text{C/W}$ |

CHARACTERISTICS

$T_j = 25\text{ }^\circ\text{C}$ unless otherwise specified

Collector cut-off current

| | | | |
|---|-----------|---|-------------------|
| $I_E = 0; V_{CB} = V_{CBOmax}$ | I_{CBO} | < | 100 μA |
| $I_E = 0; V_{CB} = \frac{1}{2} V_{CBOmax}$ | I_{CBO} | < | 100 nA |
| $I_E = 0; V_{CB} = \frac{1}{2} V_{CBOmax}; T_j = 150\text{ }^\circ\text{C}$ | I_{CBO} | < | 50 μA |

Emitter cut-off current

| | | | |
|--------------------------------|-----------|---|-------------------|
| $I_C = 0; V_{EB} = 6\text{ V}$ | I_{EBO} | < | 100 μA |
| $I_C = 0; V_{EB} = 3\text{ V}$ | I_{EBO} | < | 100 nA |

¹⁾ $I_C = 100\text{ mA}$

CHARACTERISTICS (continued)

Saturation voltages

$I_C = 100 \text{ mA}; I_B = 10 \text{ mA}$

| | | | |
|-------------|---|-----|----|
| V_{CEsat} | < | 150 | mV |
| V_{BEsat} | < | 900 | mV |

$I_C = 500 \text{ mA}; I_B = 50 \text{ mA}$ BSW66; BSW67
BSW68

| | | | |
|-------------|---|-----|----|
| V_{CEsat} | < | 400 | mV |
| V_{CEsat} | < | 500 | mV |
| V_{BEsat} | < | 1.1 | V |

$I_C = 1 \text{ A}; I_B = 150 \text{ mA}$

| | | | |
|-------------|---|-----|---|
| V_{CEsat} | < | 1 | V |
| V_{BEsat} | < | 1.4 | V |

D. C. current gain

$I_C = 10 \text{ mA}; V_{CE} = 5 \text{ V}$

| | | |
|----------|---|----|
| h_{FE} | > | 30 |
|----------|---|----|

$I_C = 100 \text{ mA}; V_{CE} = 5 \text{ V}$

| | | |
|----------|---|----|
| h_{FE} | > | 40 |
|----------|---|----|

$I_C = 500 \text{ mA}; V_{CE} = 5 \text{ V}$

| | | |
|----------|---|----|
| h_{FE} | > | 30 |
|----------|---|----|

$I_C = 1 \text{ A}; V_{CE} = 5 \text{ V}$

| | | |
|----------|---|----|
| h_{FE} | > | 15 |
|----------|---|----|

Collector capacitance at $f = 1 \text{ MHz}$

$I_E = I_e = 0; V_{CB} = 10 \text{ V}$

| | | | |
|-------|---|----|----|
| C_c | < | 35 | pF |
|-------|---|----|----|

Emitter capacitance at $f = 1 \text{ MHz}$

$I_C = I_c = 0; V_{EB} = 0$

| | | | |
|-------|---|-----|----|
| C_e | < | 650 | pF |
|-------|---|-----|----|

Transition frequency at $f = 35 \text{ MHz}$

$I_C = 100 \text{ mA}; V_{CE} = 20 \text{ V}$

| | | | |
|-------|------|----|-----|
| f_T | typ. | 80 | MHz |
|-------|------|----|-----|

Turn on time when switched from

$-V_{BE} = 4 \text{ V}$ to $I_C = 500 \text{ mA}; I_B = 50 \text{ mA}$

| | | | |
|----------|------|-----|---------------|
| t_{on} | typ. | 0.5 | μs |
|----------|------|-----|---------------|

Turn off time when switched from

$I_C = 500 \text{ mA}; I_B = 50 \text{ mA}$ to $-V_{BB} = 6.5 \text{ V}$
($-I_{BM} = 50 \text{ mA}$)

| | | | |
|-----------|------|---|---------------|
| t_{off} | typ. | 1 | μs |
|-----------|------|---|---------------|

Test circuit:

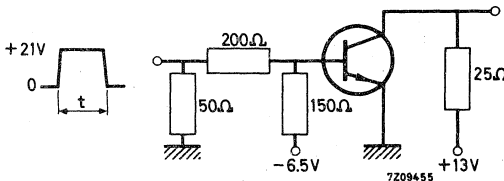

Pulse generator:

| | |
|----------------|-----------------------|
| Pulse duration | $t > 5 \mu\text{s}$ |
| Rise time | $t_r < 10 \text{ ns}$ |
| Fall time | $t_f < 10 \text{ ns}$ |

Note

$-I_{BM}$ is the reverse current that can flow during switching off. The indicated $-I_{BM}$ is determined and limited by the applied cut-off voltage and series resistance.

CHARACTERISTICS (continued)

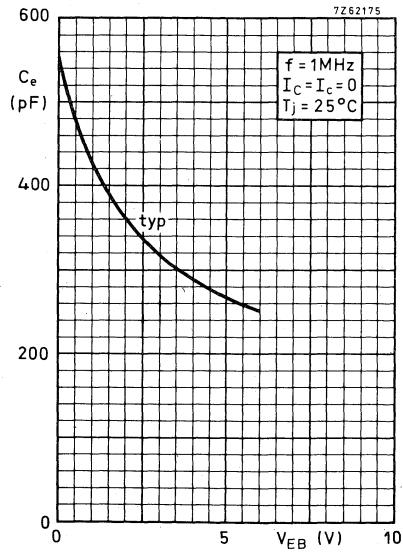
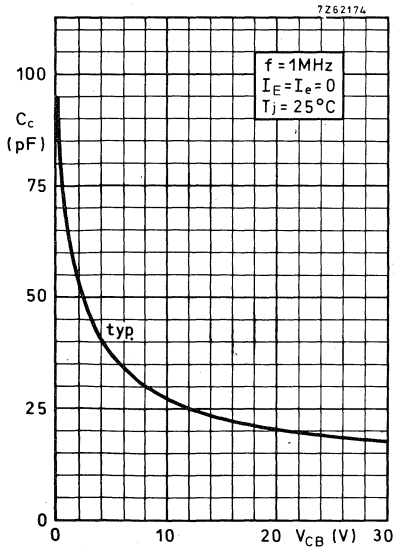
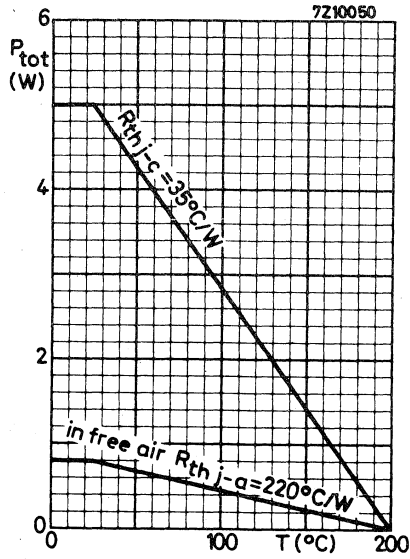

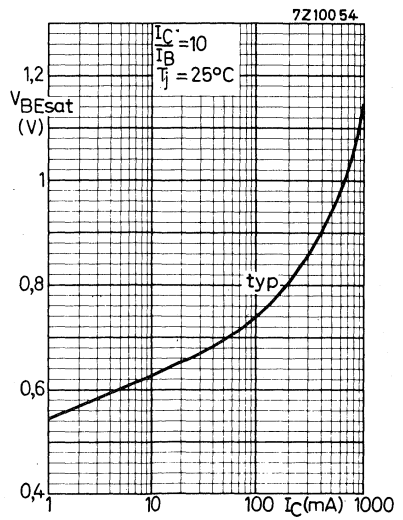
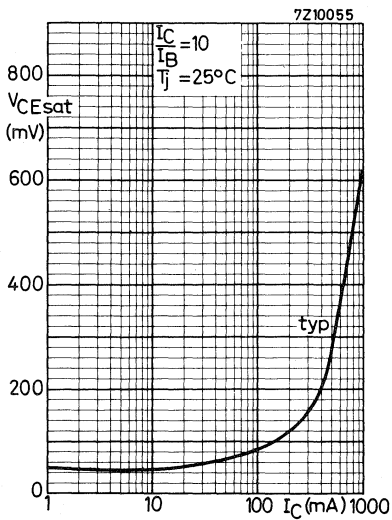
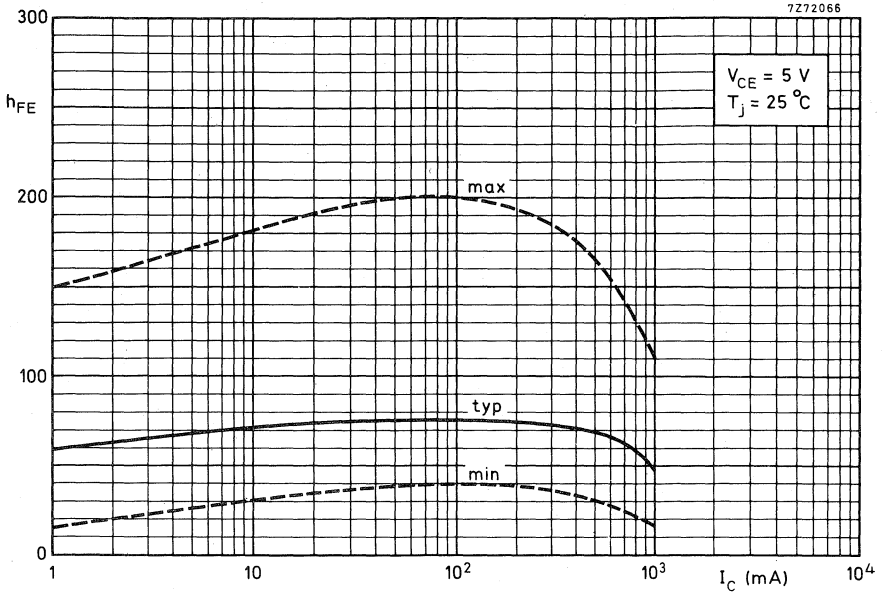

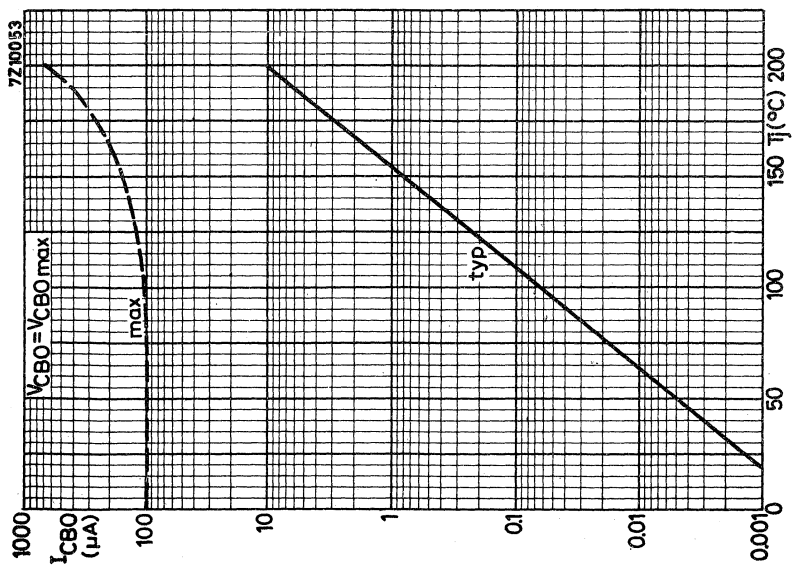
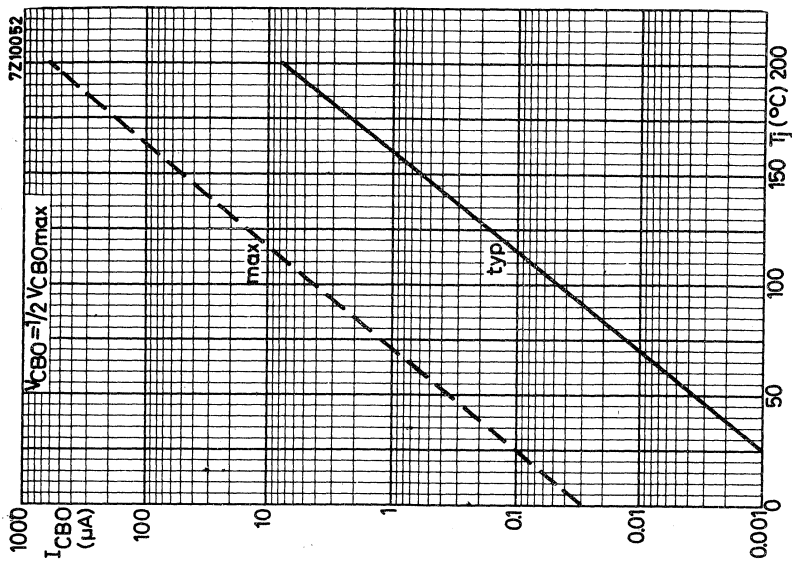

VERY HIGH SPEED SWITCHING TRANSISTORS

N-P-N silicon planar epitaxial transistors in a TO-18 metal envelope with the collector connected to the case. The BSX19 and BSX20 are primarily intended for very high speed saturated switching.

| QUICK REFERENCE DATA | | | |
|---|-----------|----------|-----------|
| | | BSX19 | BSX20 |
| Collector-base voltage (open emitter) | V_{CBO} | max. 40 | 40 V |
| Collector-emitter voltage (open base) | V_{CEO} | max. 15 | 15 V |
| Collector-emitter voltage ($V_{BE} = 0$) | V_{CES} | max. 40 | 40 V |
| Collector current (peak value) | I_{CM} | max. 500 | 500 mA |
| Total power dissipation up to $T_{amb} = 25\text{ }^{\circ}\text{C}$ | P_{tot} | max. 360 | 360 mW |
| D.C. current gain at $T_j = 25\text{ }^{\circ}\text{C}$ | | | |
| $I_C = 10\text{ mA}; V_{CE} = 1\text{ V}$ | h_{FE} | 20 to 60 | 40 to 120 |
| $I_C = 100\text{ mA}; V_{CE} = 2\text{ V}$ | h_{FE} | > 10 | 20 |
| Transition frequency | | | |
| $I_C = 10\text{ mA}; V_{CE} = 10\text{ V}$ | f_T | > 400 | 500 MHz |
| Storage time | | | |
| $I_C = I_B = -I_{BM} = 10\text{ mA}$ | t_s | < 10 | 13 ns |

MECHANICAL DATA

Collector connected to case
TO-18

Dimensions in mm

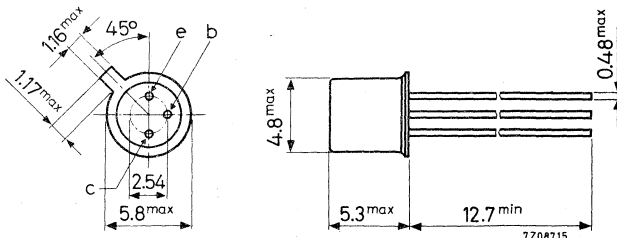

Accessories available: 56246, 56263

RATINGS (Limiting values) ¹⁾

Voltages

| | | | |
|---|-----------|------|-------|
| Collector-base voltage (open emitter) | V_{CBO} | max. | 40 V |
| Collector-emitter voltage (open base) | V_{CEO} | max. | 15 V |
| Collector-emitter voltage with $V_{BE} = 0$ | V_{CES} | max. | 40 V |
| Emitter-base voltage (open collector) | V_{EBO} | max. | 4.5 V |

Current

| | | | |
|---|----------|------|--------|
| Collector current (peak value; $t = 10 \mu s$) | I_{CM} | max. | 500 mA |
|---|----------|------|--------|

Power dissipation

| | | | |
|---|-----------|------|--------|
| Total power dissipation up to $T_{amb} = 25 \text{ }^\circ\text{C}$ | P_{tot} | max. | 360 mW |
|---|-----------|------|--------|

Temperatures

| | | | |
|----------------------|-----------|-------------|------------------|
| Storage temperature | T_{stg} | -65 to +200 | $^\circ\text{C}$ |
| Junction temperature | T_j | max. 200 | $^\circ\text{C}$ |

THERMAL RESISTANCE

| | | | |
|--------------------------------------|--------------|---|---------------------------------|
| From junction to ambient in free air | $R_{th j-a}$ | = | 0.48 $^\circ\text{C}/\text{mW}$ |
| From junction to case | $R_{th j-c}$ | = | 0.15 $^\circ\text{C}/\text{mW}$ |

¹⁾ Limiting values according to the Absolute Maximum System as defined in IEC publication 134.

CHARACTERISTICS

$T_j = 25\text{ }^\circ\text{C}$ unless otherwise specified

Collector cut-off current

| | | | |
|--|-----------|---|--------------------|
| $I_E = 0; V_{CB} = 20\text{ V}$ | I_{CBO} | < | 400 nA |
| $I_E = 0; V_{CB} = 20\text{ V}; T_j = 150\text{ }^\circ\text{C}$ | I_{CBO} | < | 30 μA |
| $V_{BE} = 0; V_{CE} = 15\text{ V}; T_j = 55\text{ }^\circ\text{C}$ | I_{CES} | < | 0.40 μA |
| $V_{BE} = 0; V_{CE} = 40\text{ V}$ | I_{CES} | < | 1.0 μA |

Emitter cut-off current

| | | | |
|----------------------------------|-----------|---|------------------|
| $I_C = 0; V_{EB} = 4.5\text{ V}$ | I_{EBO} | < | 10 μA |
|----------------------------------|-----------|---|------------------|

Currents at reverse biased emitter junction

| | | | |
|--|------------|---|--------------------|
| $V_{CE} = 15\text{ V}; -V_{BE} = 3\text{ V}; T_j = 55\text{ }^\circ\text{C}$ | I_{CEX} | < | 0.60 μA |
| | $-I_{BEX}$ | < | 0.60 μA |

Sustaining voltages

| | | | |
|---|----------------------|---|------|
| $I_C = 10\text{ mA}; I_B = 0$ | $V_{CEO\text{sust}}$ | > | 15 V |
| $I_C = 10\text{ mA}; R_{BE} = 10\text{ }\Omega$ | $V_{CER\text{sust}}$ | > | 20 V |

Base-emitter voltage (see also page 8)

| | | | |
|--|----------|---|--------|
| $I_C = 30\text{ }\mu\text{A}; V_{CE} = 20\text{ V}; T_j = 100\text{ }^\circ\text{C}$ | V_{BE} | > | 0.35 V |
|--|----------|---|--------|

Saturation voltages

| | | | |
|--|--------------------|---|----------------|
| $I_C = 10\text{ mA}; \text{BSX19: } I_B = 0.6\text{ mA}$ $\text{BSX20: } I_B = 0.3\text{ mA}$ | $V_{CE\text{sat}}$ | < | 0.3 V |
| $I_C = 10\text{ mA}; I_B = 1\text{ mA}$ | $V_{CE\text{sat}}$ | < | 0.25 V |
| | $V_{BE\text{sat}}$ | > | 0.70 to 0.85 V |
| $I_C = 100\text{ mA}; I_B = 10\text{ mA}$ | $V_{CE\text{sat}}$ | < | 0.60 V |
| | $V_{BE\text{sat}}$ | < | 1.50 V |

Collector capacitance at $f = 1\text{ MHz}$

| | | | |
|--------------------------------------|-------|---|------|
| $I_E = I_e = 0; V_{CB} = 5\text{ V}$ | C_c | < | 4 pF |
|--------------------------------------|-------|---|------|

Emitter capacitance at $f = 1\text{ MHz}$

| | | | |
|--------------------------------------|-------|---|--------|
| $I_C = I_c = 0; V_{EB} = 1\text{ V}$ | C_e | < | 4.5 pF |
|--------------------------------------|-------|---|--------|

CHARACTERISTICS (continued)

$T_j = 25\text{ }^\circ\text{C}$ unless otherwise specified

D.C. current gain

$I_C = 10\text{ mA}; V_{CE} = 1\text{ V}$

h_{FE}

BSX19

BSX20

20 to 60

40 to 120

$I_C = 10\text{ mA}; V_{CE} = 1\text{ V}; T_j = -55\text{ }^\circ\text{C}$

h_{FE}

> 10

20

$I_C = 100\text{ mA}; V_{CE} = 2\text{ V}$

h_{FE}

> 10

20

Transition frequency

$I_C = 10\text{ mA}; V_{CE} = 10\text{ V}$

f_T

> 400
typ. 500

500 MHz
600 MHz

Switching times

Storage time (see also pages 20 and 21)

$I_C = I_B = -I_{BM} = 10\text{ mA}$

t_s

typ. 5
< 10

6 ns
13 ns

Test circuit:

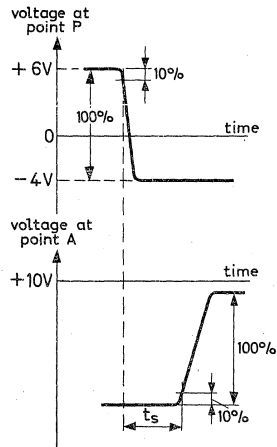
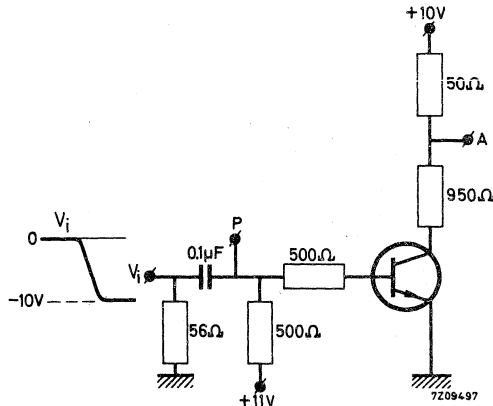

Pulse generator:

Rise time $t_R < 1\text{ ns}$
Pulse duration $t > 300\text{ ns}$
Duty cycle $\delta < 0.02$
Source impedance $R_S = 50\text{ }\Omega$

Oscilloscope:

Input impedance $R_i = 50\text{ }\Omega$
Rise time $t_R < 1\text{ ns}$

CHARACTERISTICS (continued)

$T_j = 25^\circ\text{C}$ unless otherwise specified

Switching times

Turn on time (see also pages 14 and 15)

from $-V_{BE} = 1.5\text{ V}$ to $I_C = 10\text{ mA}$; $I_B = 3\text{ mA}$

$t_{on} < 12\text{ ns}$

from $-V_{BE} = 2.25\text{ V}$ to $I_C = 100\text{ mA}$; $I_B = 40\text{ mA}$

$t_{on} < 7\text{ ns}$

Turn off time (see also pages 16 to 19)

from $I_C = 10\text{ mA}$; $I_B = 3\text{ mA}$

BSX 19

$t_{off} < 15\text{ ns}$

to cut-off with $-I_{BM} = 1.5\text{ mA}$

BSX 20

$t_{off} < 18\text{ ns}$

from $I_C = 100\text{ mA}$; $I_B = 40\text{ mA}$ to cut-off

BSX 19

$t_{off} < 18\text{ ns}$

with $-I_{BM} = 20\text{ mA}$

BSX 20

$t_{off} < 21\text{ ns}$

Test circuit:

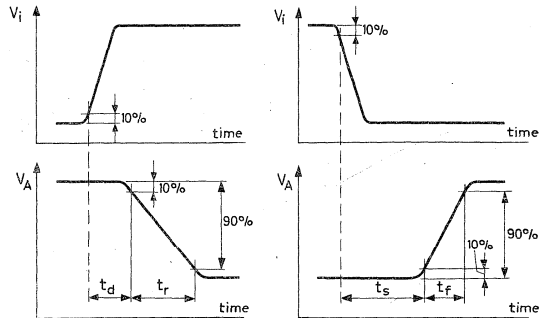
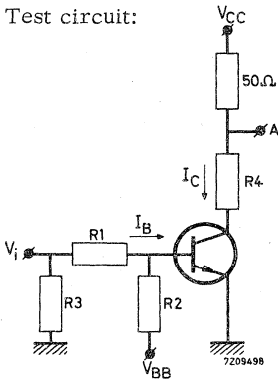

Pulse generator:

Rise time $t_r < 1\text{ ns}$

Pulse duration $t > 300\text{ ns}$

Duty cycle $\delta < 0.02$

Source impedance $R_S = 50\ \Omega$

Oscilloscope:

Input impedance $R_i = 50\ \Omega$

Rise time $t_r < 1\text{ ns}$

| I_C (mA) | I_B (mA) | $-I_{BM}$ (mA) | V_{CC} (V) | $R_1;R_2$ (k Ω) | R_3 (Ω) | R_4 (Ω) | turn on time | | | turn off time | |
|---------------|---------------|-------------------|-----------------|----------------------------|-----------------------|-----------------------|------------------|------------------|--------------|-----------------|---------------|
| | | | | | | | $-V_{BB}$ (V) | $-V_{BE}$ (V) | V_i (V) | V_{BB} (V) | $-V_i$ (V) |
| 10 | 3 | 1.5 | 3 | 3.3 | 50 | 220 | 3.0 | 1.5 | 15 | 12.0 | 15 |
| 100 | 40 | 20 | 6 | 0.33 | 56 | 0 | 4.5 | 2.25 | 20 | 15.3 | 20 |

Note

$-I_{BM}$ is the reverse current that can flow during switching off. The indicated $-I_{BM}$ is determined and limited by the applied cut-off voltage and series resistance.

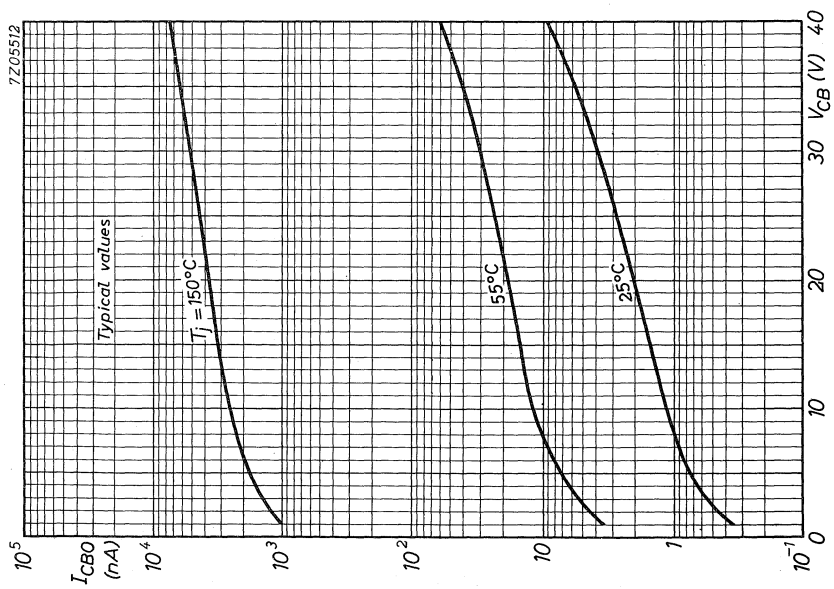
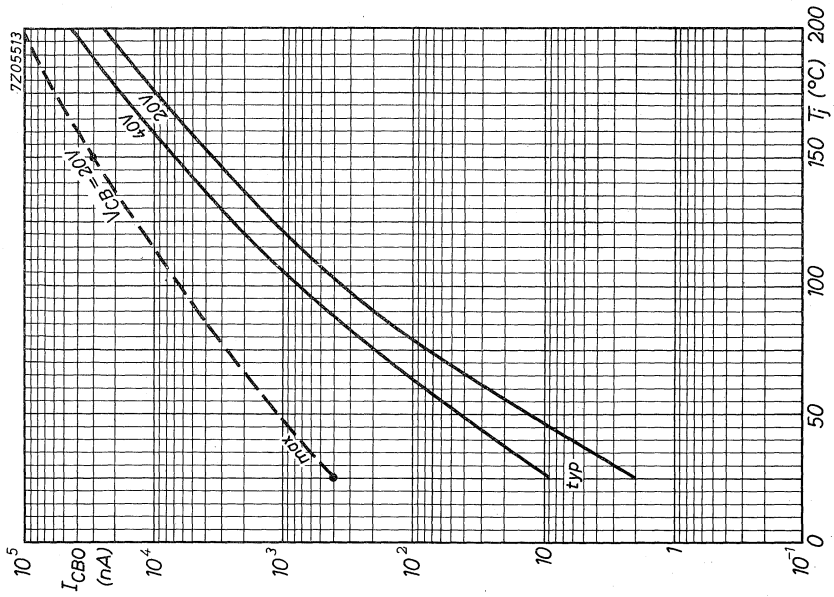

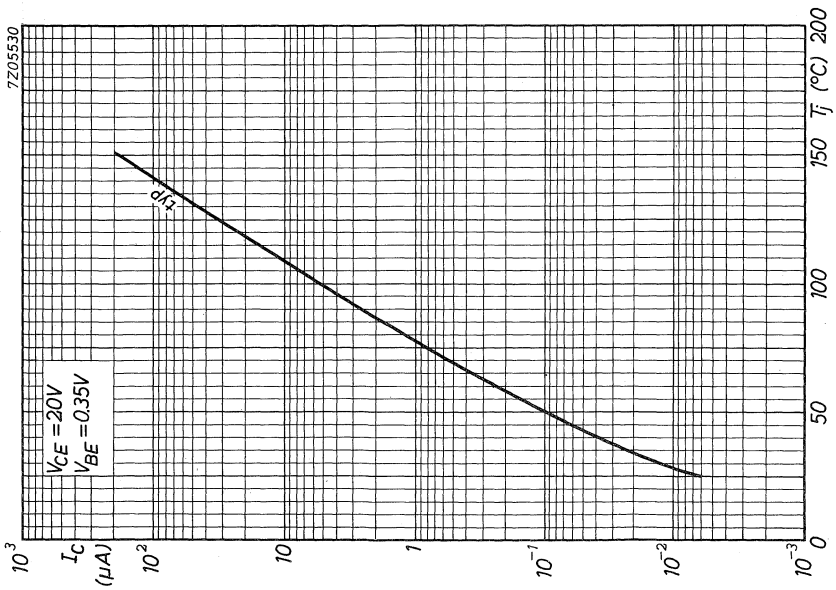
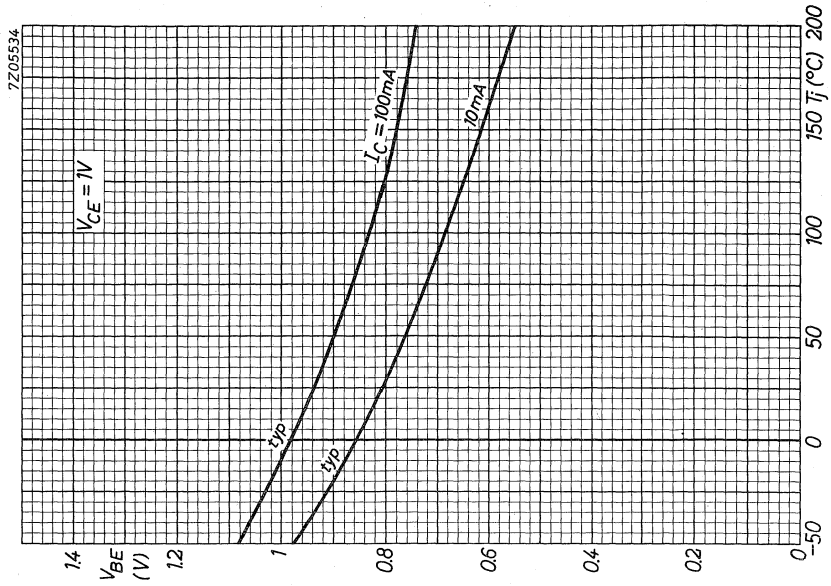

BSX19
BSX20

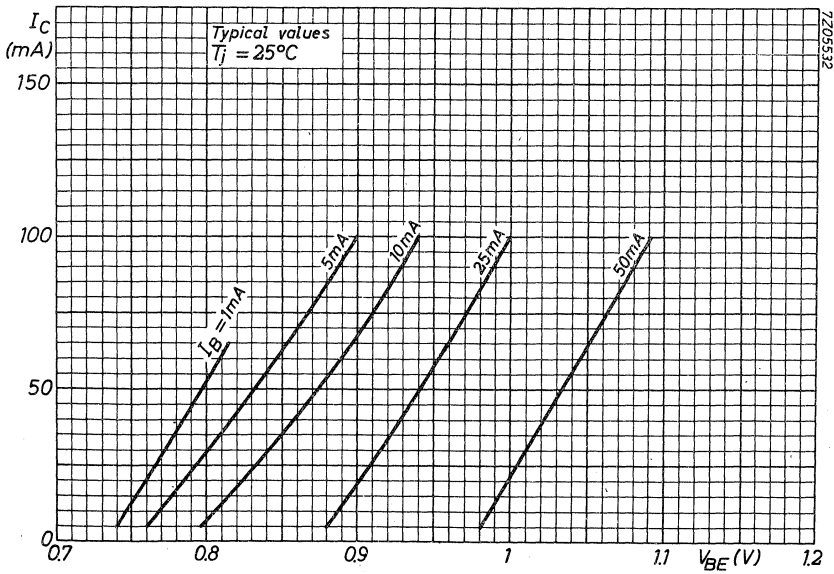
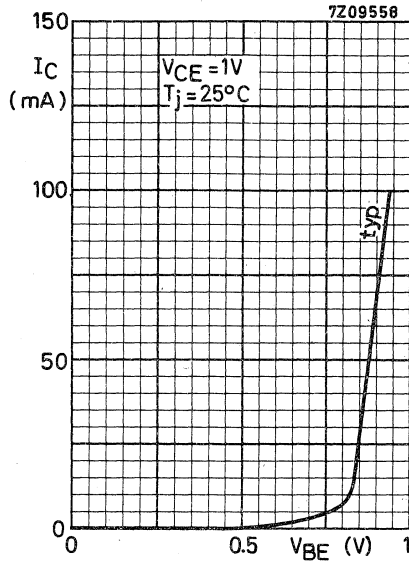
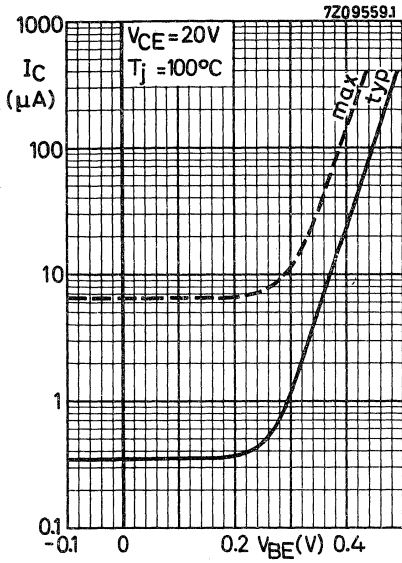

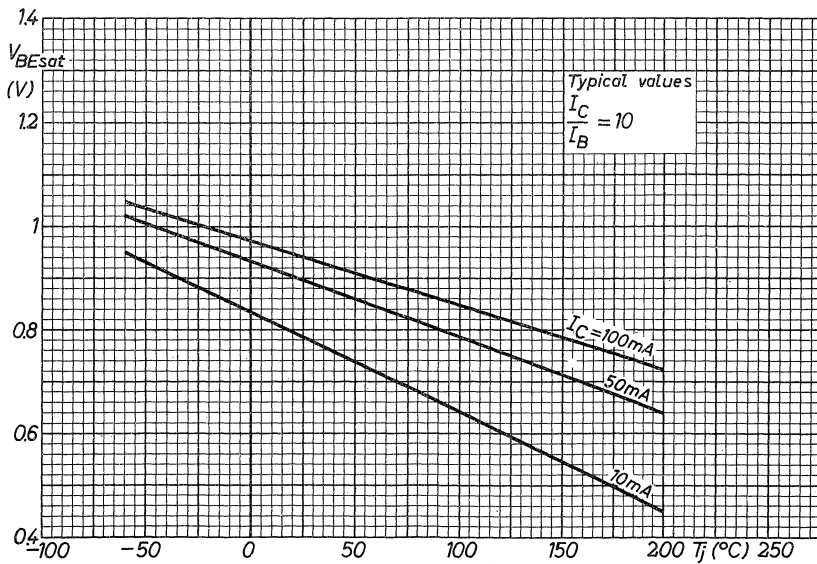
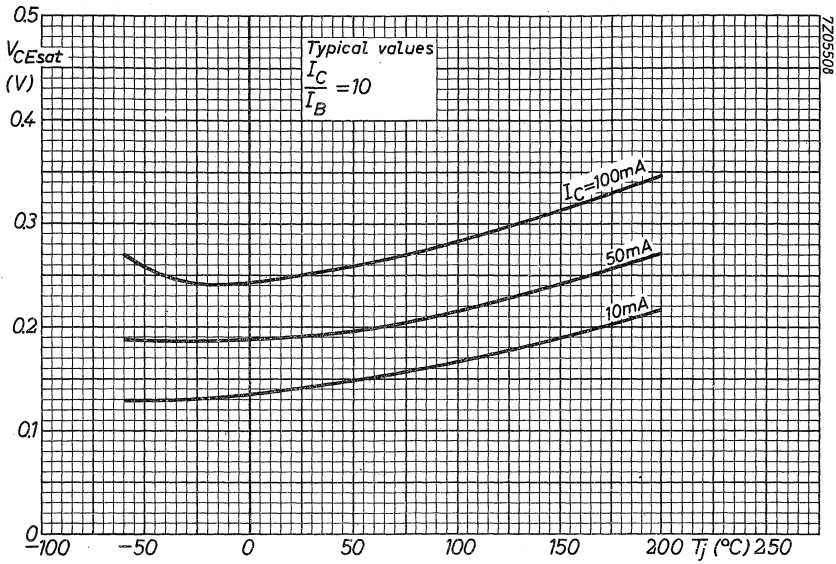

**BSX19
BSX20**

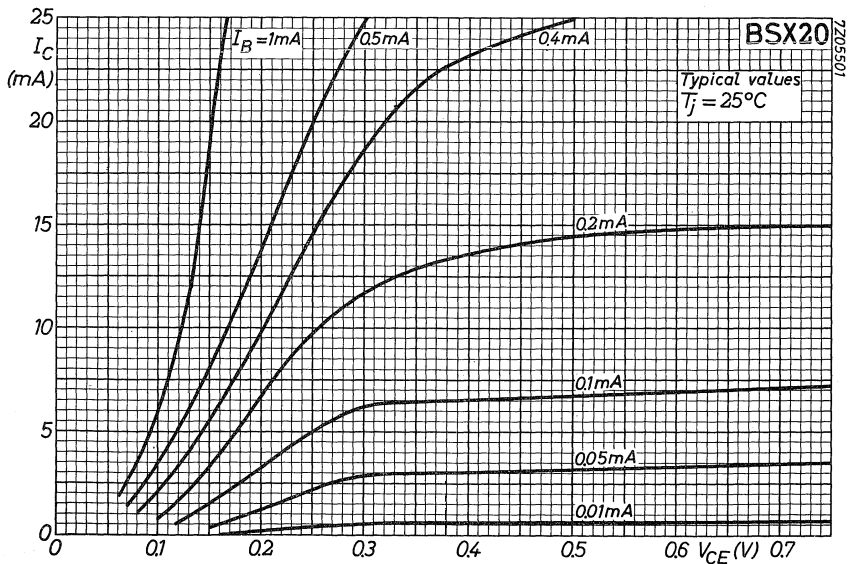
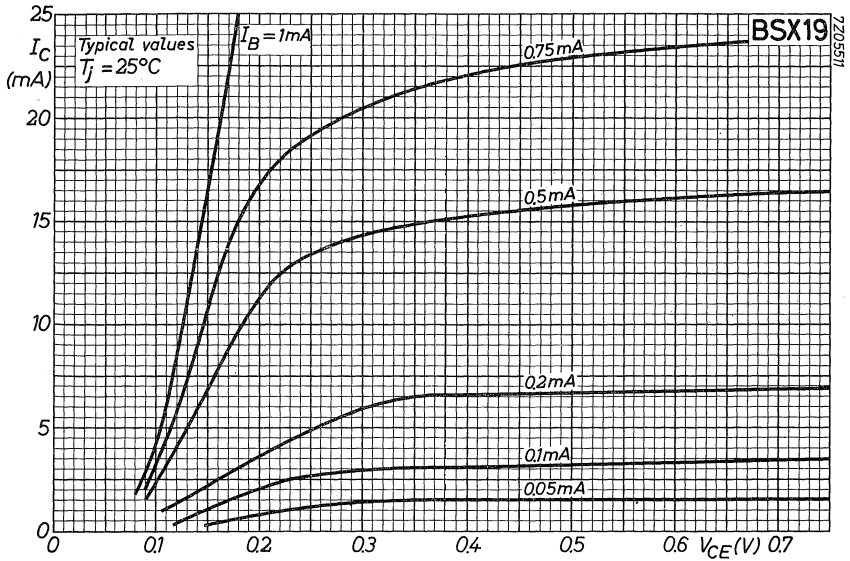

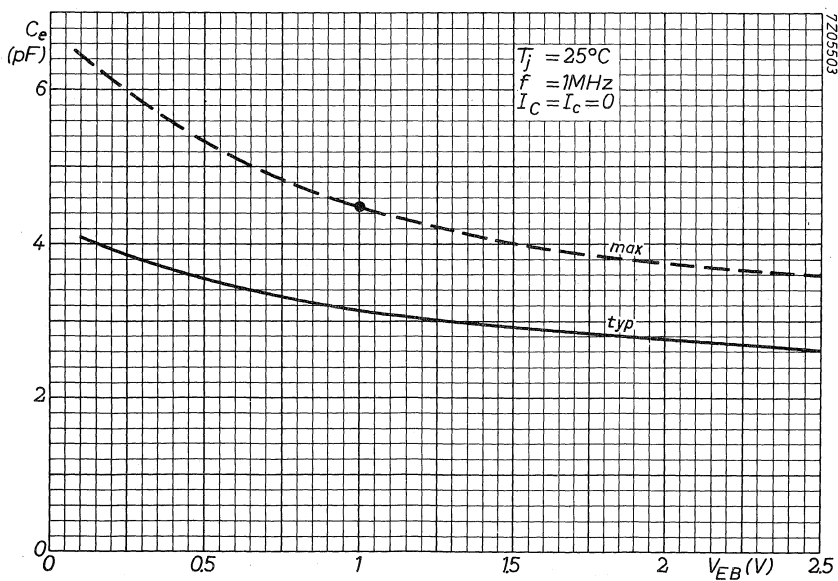
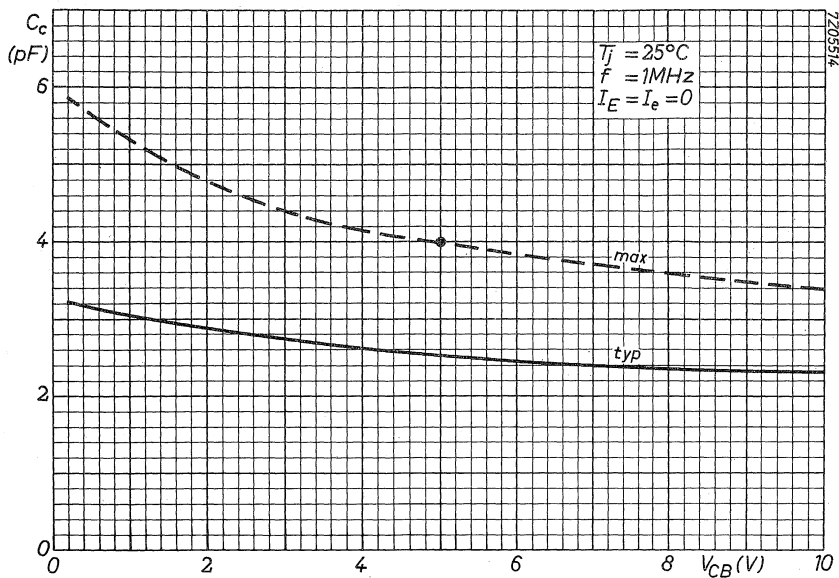

BSX19
BSX20

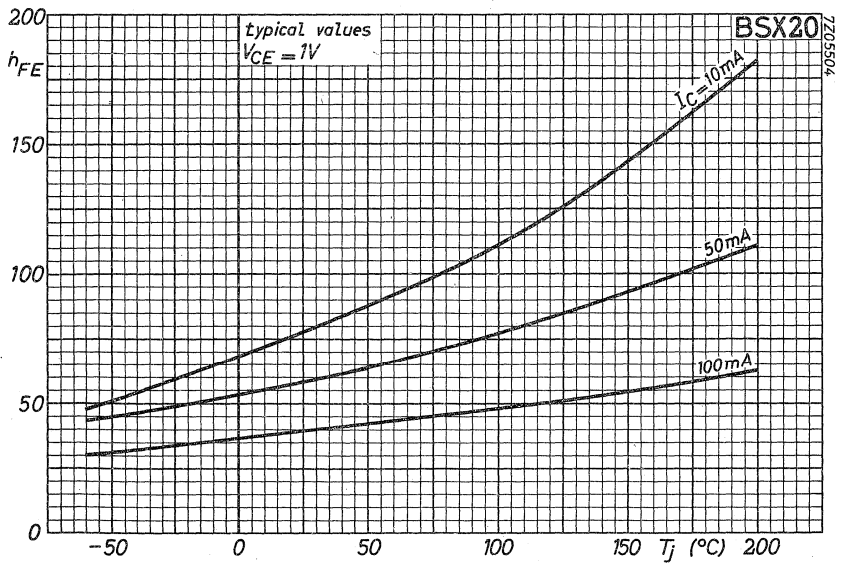
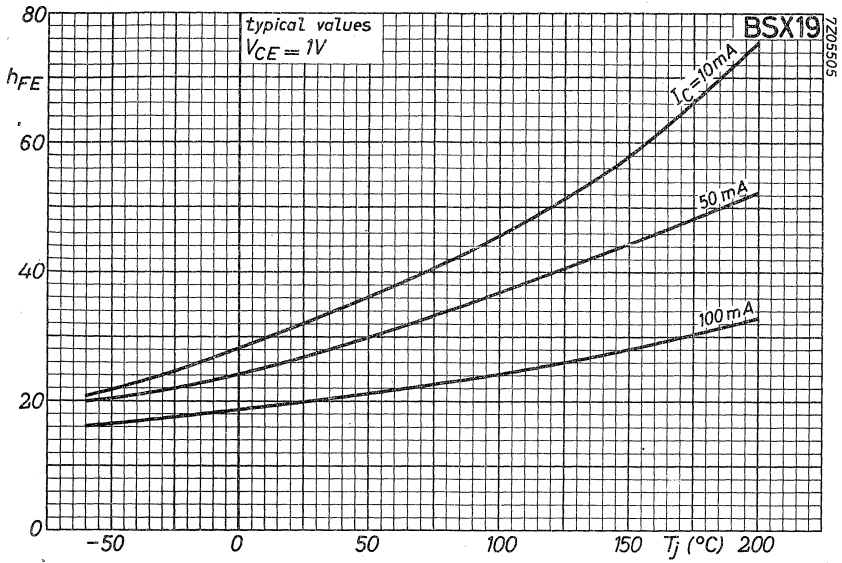

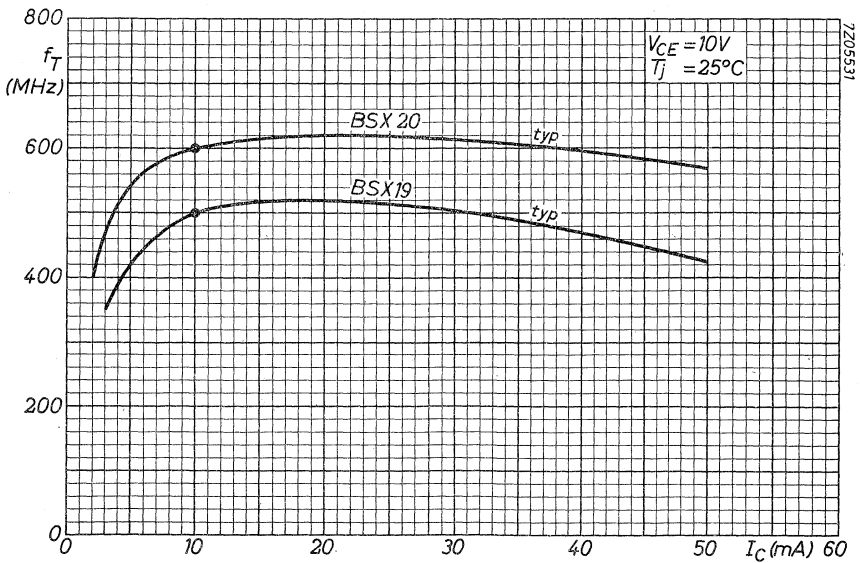
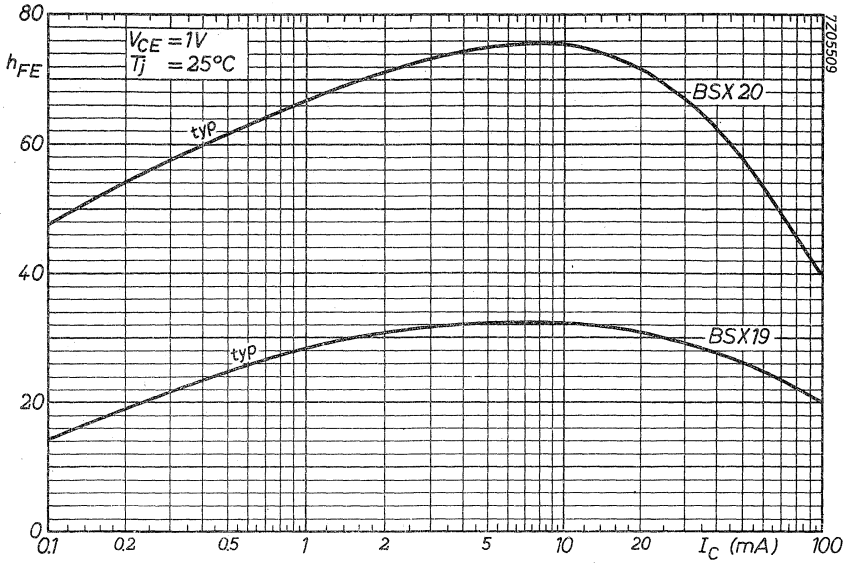

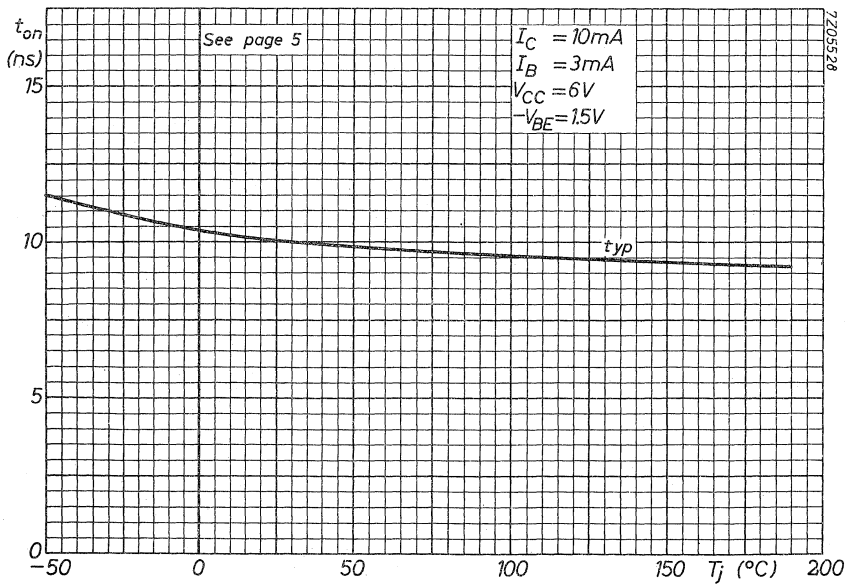
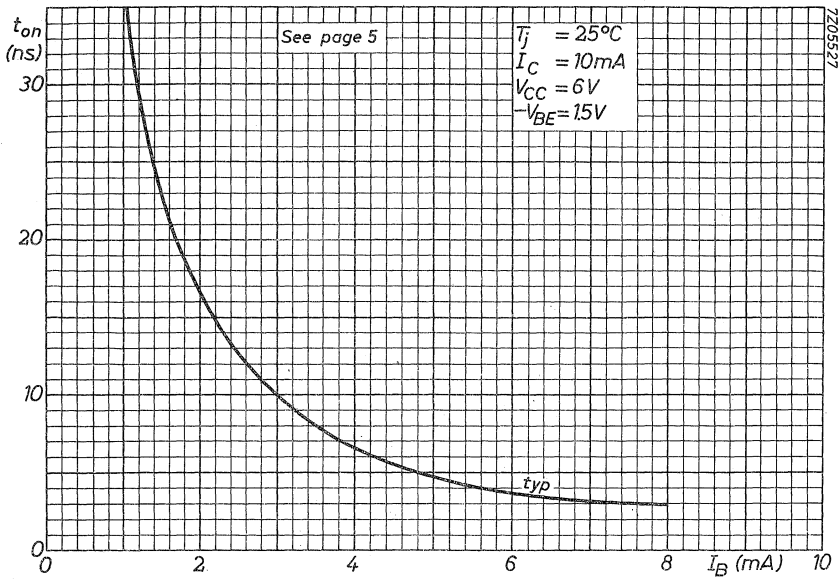

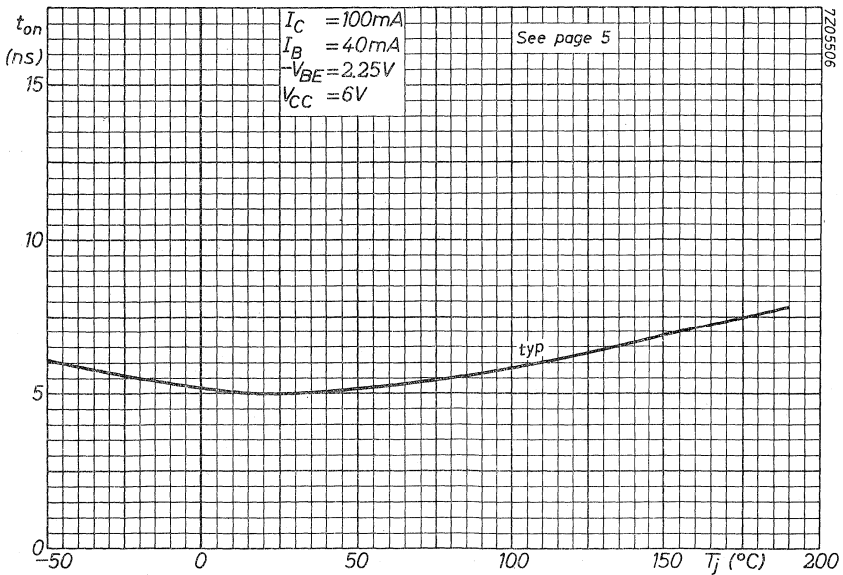
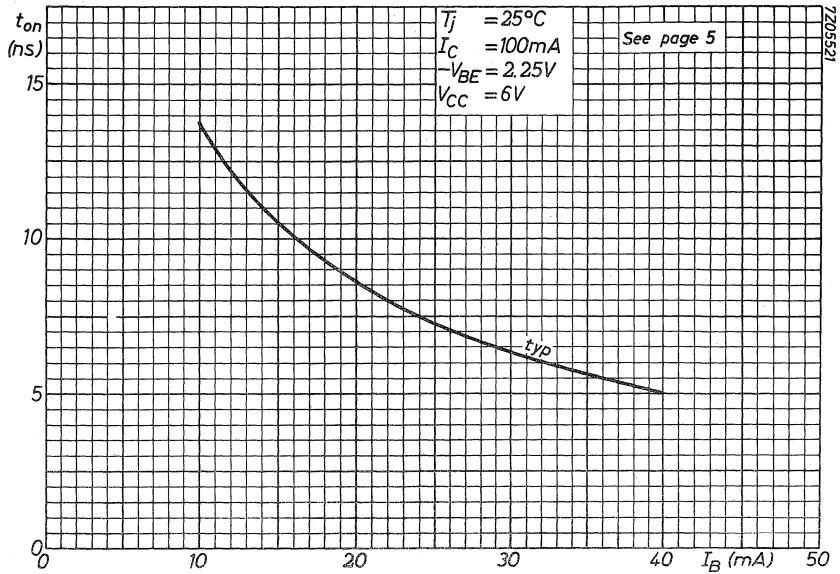

BSX19
BSX20

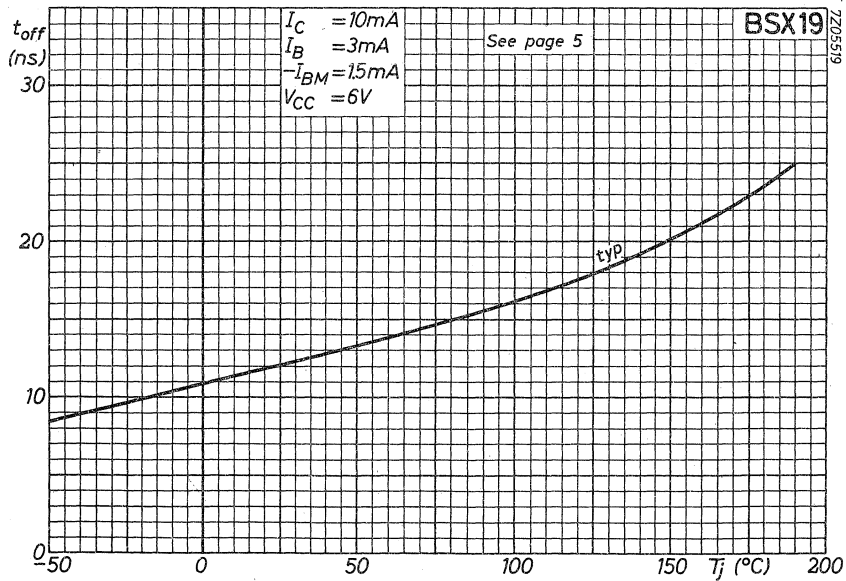
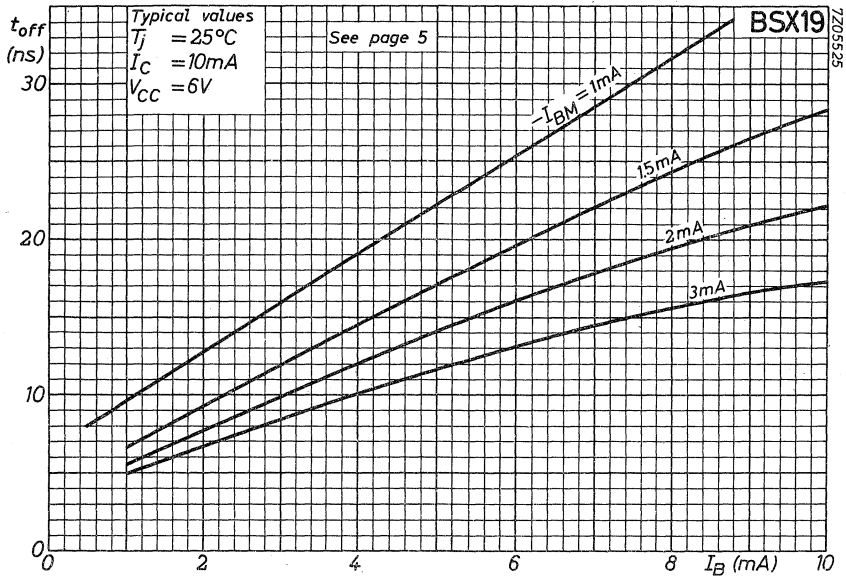

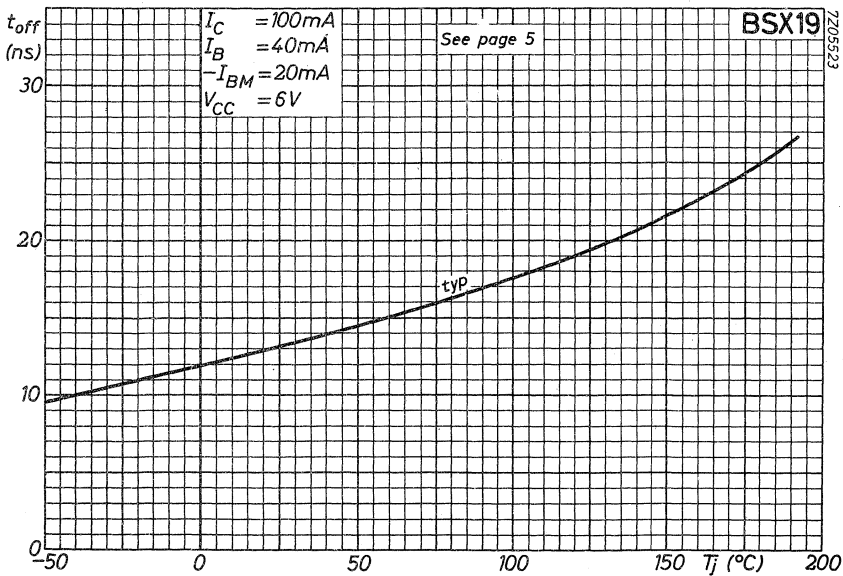
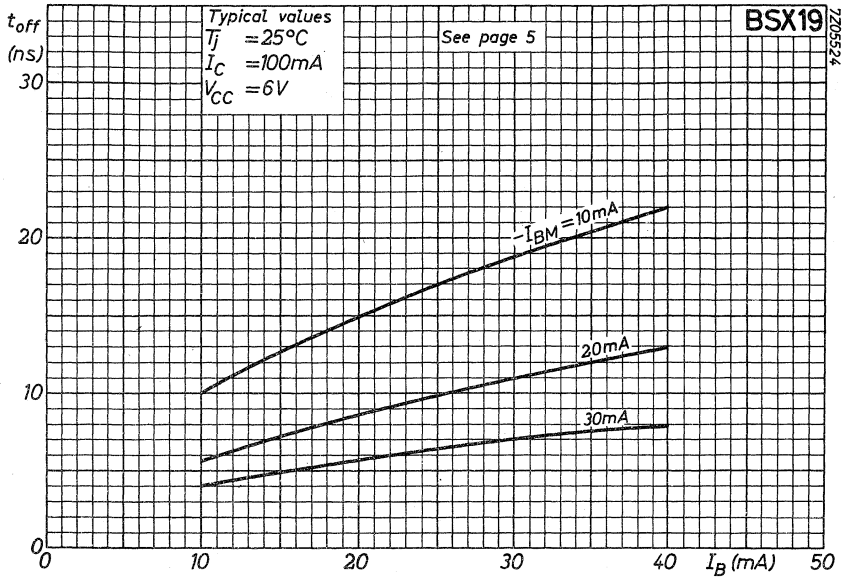

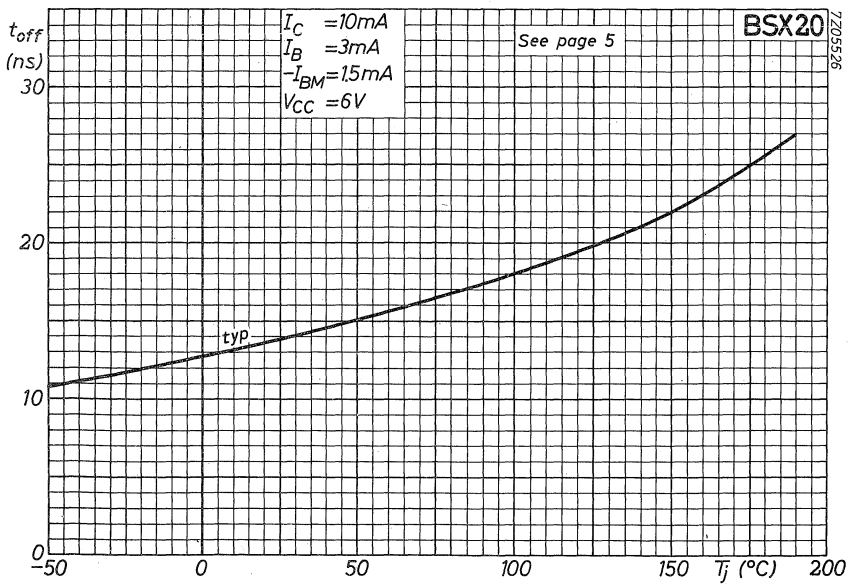
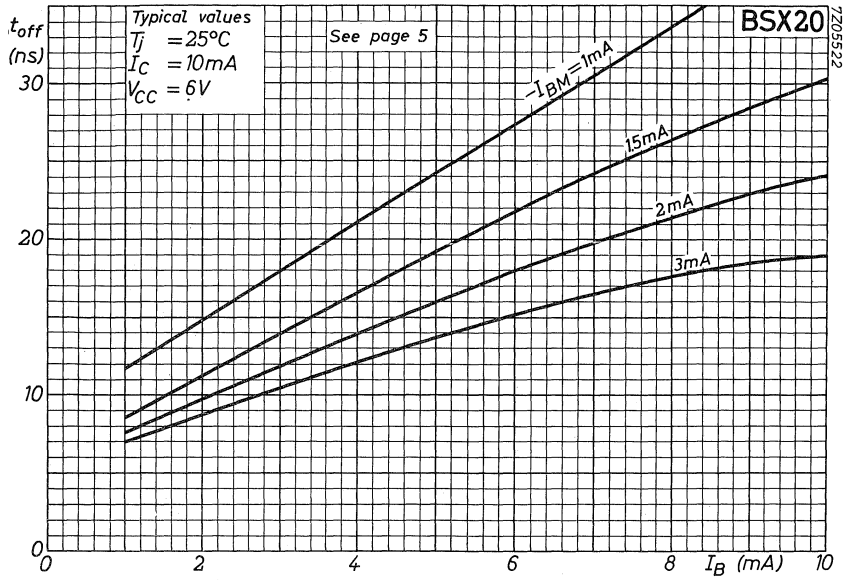

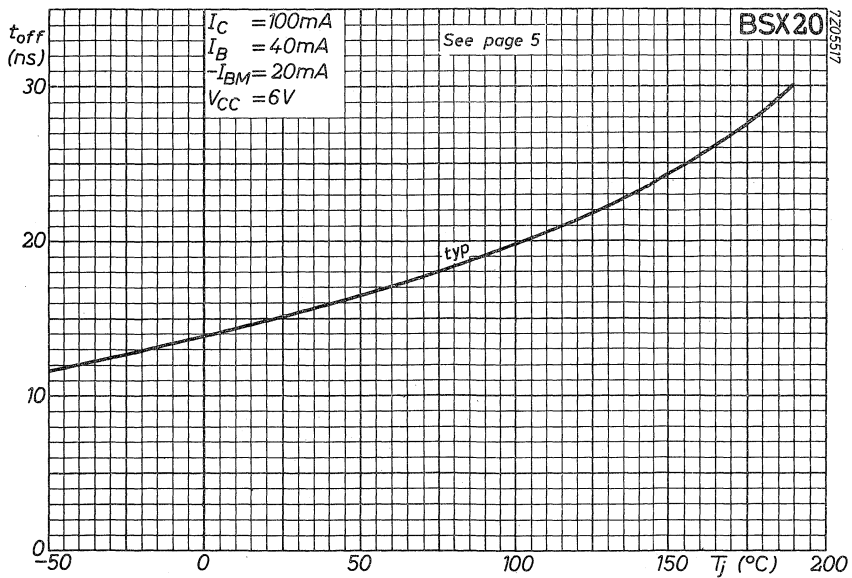
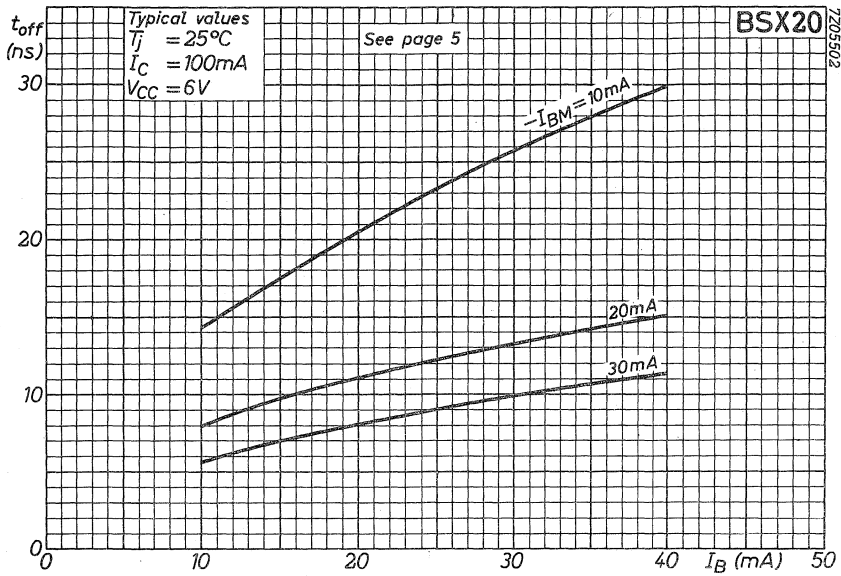

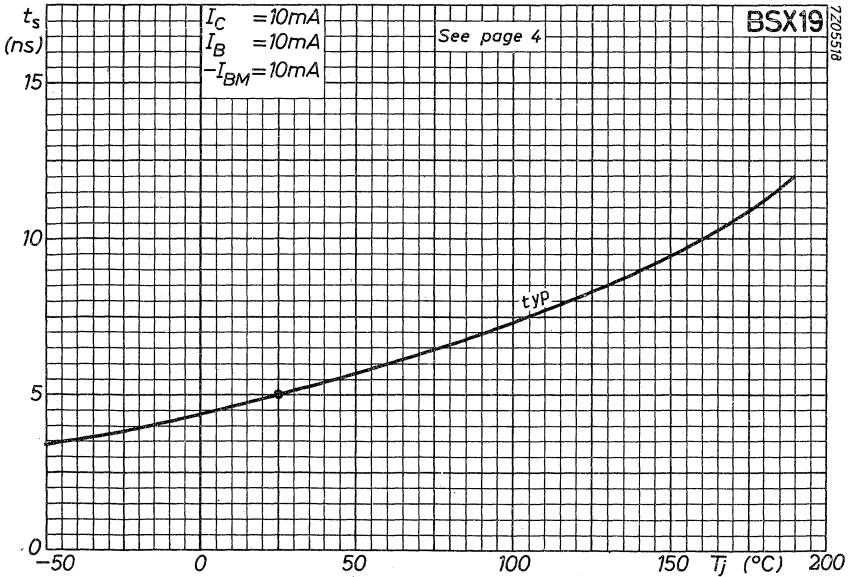
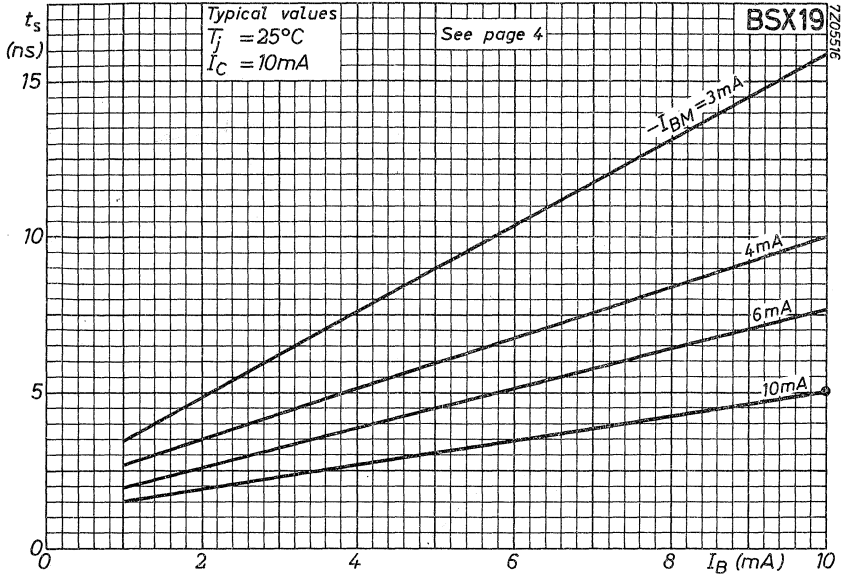

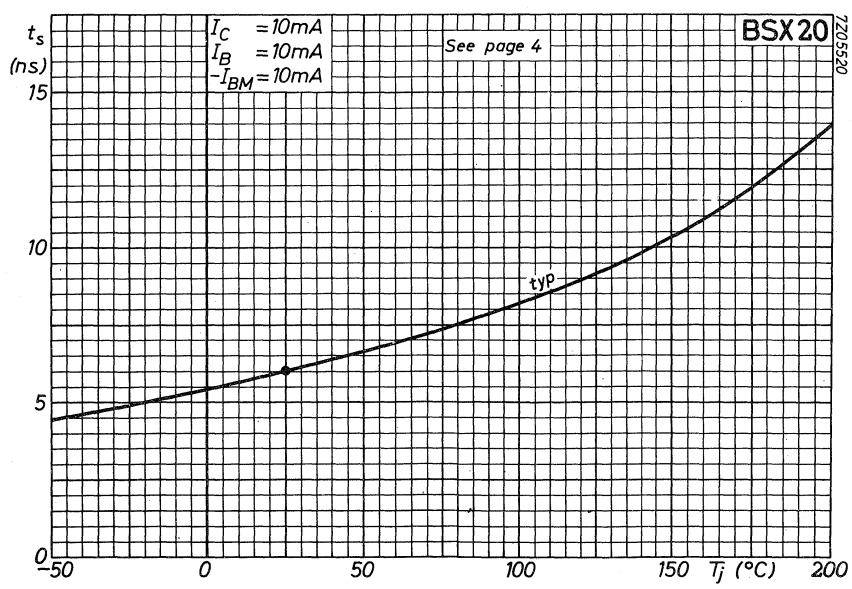
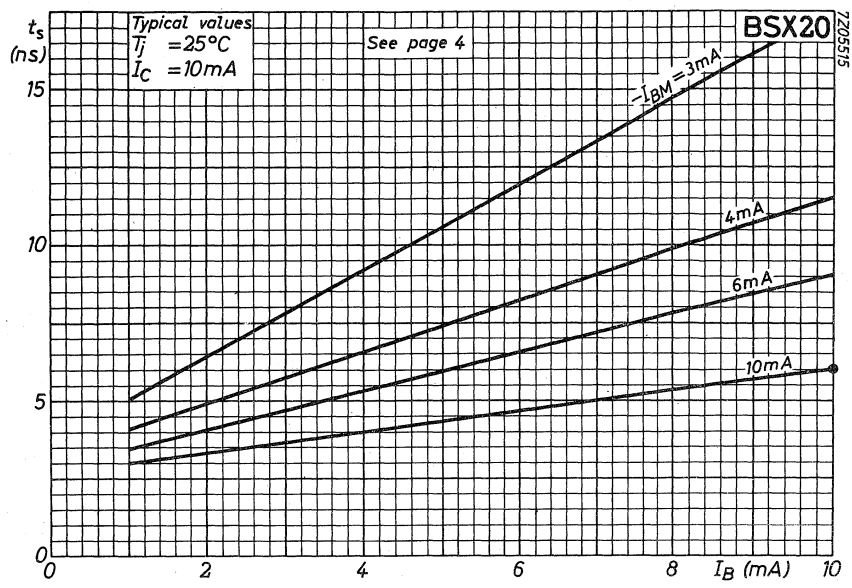

APPLICATION INFORMATION

NAND gate circuit (Diode Transistor Logic)

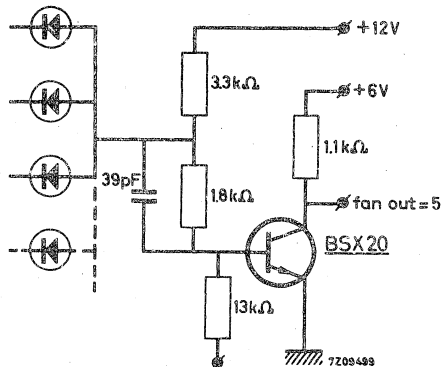

Delay time per stage; fan in = 5

t_d typ. 15 ns

Note

Fan out = 5 means: The circuit may be loaded by maximum 5 circuits, each presenting a load identical to that of one input branch of the circuit itself.

SILICON PLANAR EPITAXIAL TRANSISTOR

N-P-N transistor in a TO-18 metal envelope, with the collector connected to the case.

It is primarily intended for driving numerical indicator tubes.

| QUICK REFERENCE DATA | | |
|--|-----------|-----------------------------|
| Collector-base voltage (open emitter) | V_{CBO} | max. 120 V |
| Collector-emitter voltage (open base) | V_{CEO} | max. 80 V |
| Collector current (peak value) | I_{CM} | max. 250 mA |
| Total power dissipation up to $T_{amb} = 25\text{ }^{\circ}\text{C}$ | P_{tot} | max. 300 mW |
| Junction temperature | T_j | max. 175 $^{\circ}\text{C}$ |
| D.C. current gain at $T_j = 25\text{ }^{\circ}\text{C}$ $I_C = 4\text{ mA}; V_{CE} = 1\text{ V}$ | h_{FE} | > 20 typ. 80 |
| Transition frequency at $f = 35\text{ MHz}$ $I_C = 4\text{ mA}; V_{CE} = 10\text{ V}$ | f_T | > 60 MHz |
| NOTE: The BSX21 may be operated in the breakdown region up to $V_{CE} = 160\text{ V}$, provided P_{tot} at $T_{amb} = 85\text{ }^{\circ}\text{C}$ does not exceed 100 mW. | | |

MECHANICAL DATA

Dimensions in mm

Collector connected to case

TO-18

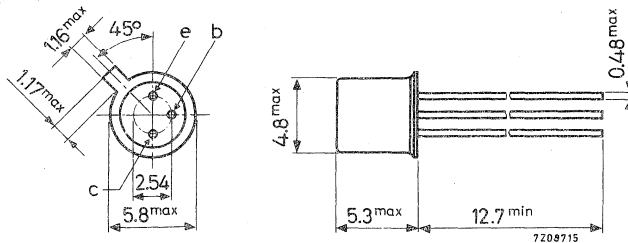

Accessories available: 56246, 56263

BSX21

RATINGS Limiting values in accordance with the Absolute Maximum System (IEC 134)

Voltages

Collector-base voltage (open emitter)

$$I_C = 100 \mu\text{A}$$

$$V_{CBO} \quad \text{max.} \quad 120 \text{ V } ^1)$$

Collector-emitter voltage (open base)

$$I_C = 4 \text{ mA}$$

$$V_{CEO} \quad \text{max.} \quad 80 \text{ V } ^1)$$

Emitter-base voltage (open collector)

$$I_E = 100 \mu\text{A}$$

$$V_{EBO} \quad \text{max.} \quad 5 \text{ V}$$

Currents

Collector current (d.c. or average over
any 20 ms period)

$$I_C \quad \text{max.} \quad 100 \text{ mA}$$

Collector current (peak value)

$$I_{CM} \quad \text{max.} \quad 250 \text{ mA } ^2)$$

Emitter current (d.c. or average over
any 20 ms period)

$$-I_E \quad \text{max.} \quad 100 \text{ mA}$$

Emitter current (peak value)

$$-I_{EM} \quad \text{max.} \quad 250 \text{ mA}$$

Power dissipation

Total power dissipation up to $T_{amb} = 25 \text{ }^\circ\text{C}$

$$P_{tot} \quad \text{max.} \quad 300 \text{ mW}$$

Temperatures

Storage temperature

$$T_{stg} \quad -65 \text{ to } +175 \text{ }^\circ\text{C}$$

Junction temperature

$$T_j \quad \text{max.} \quad 175 \text{ }^\circ\text{C}$$

THERMAL RESISTANCE

From junction to ambient in free air

$$R_{th \text{ j-a}} = 0.5 \text{ }^\circ\text{C/mW}$$

From junction to case

$$R_{th \text{ j-c}} = 0.15 \text{ }^\circ\text{C/mW}$$

1) The BSX21 may be operated in the breakdown region up to $V_{CE} = 160 \text{ V}$, provided P_{tot} at $T_{amb} = 85 \text{ }^\circ\text{C}$ does not exceed 100 mW.

2) The transistor can withstand a capacitive load of 500 pF, combined with a collector-base voltage of max. 150 V before switching on.

CHARACTERISTICS

$T_j = 25\text{ }^\circ\text{C}$ unless otherwise specified

Collector cut-off current

| | | |
|--|-----------|---|
| $I_E = 0; V_{CB} = 90\text{ V}$ | I_{CBO} | typ. 1 nA < 200 nA |
| $I_E = 0; V_{CB} = 90\text{ V}; T_j = 150\text{ }^\circ\text{C}$ | I_{CBO} | typ. 0.25 μA < 50 μA |
| $V_{BE} = 0; V_{CE} = 80\text{ V}; T_j = 85\text{ }^\circ\text{C}$ | I_{CES} | typ. 0.01 μA < 20 μA |

Emitter cut-off current

| | | |
|---|-----------|---|
| $I_C = 0; V_{EB} = 4\text{ V}$ | I_{EBO} | typ. 0.5 nA < 200 nA |
| $I_C = 0; V_{EB} = 4\text{ V}; T_j = 150\text{ }^\circ\text{C}$ | I_{EBO} | typ. 0.05 μA < 50 μA |

Saturation voltages

| | | |
|--|-------------|---------|
| $I_C = 4\text{ mA}; I_B = 400\text{ } \mu\text{A}$ | V_{CEsat} | < 0.7 V |
| | V_{BEsat} | < 1.2 V |

D. C. current gain

| | | |
|---|----------|---------|
| $I_C = 1\text{ mA}; V_{CE} = 1\text{ V}$ | h_{FE} | typ. 60 |
| $I_C = 4\text{ mA}; V_{CE} = 1\text{ V}$ | h_{FE} | > 20 |
| $I_C = 10\text{ mA}; V_{CE} = 1\text{ V}$ | h_{FE} | typ. 80 |
| $I_C = 20\text{ mA}; V_{CE} = 1\text{ V}$ | h_{FE} | typ. 82 |
| | h_{FE} | typ. 55 |

Collector capacitance at $f = 1\text{ MHz}$

| | | |
|---------------------------------------|-------|-------------------------|
| $I_E = I_e = 0; V_{CB} = 10\text{ V}$ | C_c | typ. 3.4 pF < 4.5 pF |
|---------------------------------------|-------|-------------------------|

Emitter capacitance at $f = 1\text{ MHz}$

| | | |
|--|-------|-----------------------|
| $I_C = I_c = 0; V_{EB} = 0.5\text{ V}$ | C_e | typ. 12 pF < 17 pF |
|--|-------|-----------------------|

Transition frequency at $f = 35\text{ MHz}$

| | | |
|---|-------|--------------------------|
| $I_C = 4\text{ mA}; V_{CE} = 10\text{ V}$ | f_T | > 60 MHz typ. 160 MHz |
|---|-------|--------------------------|

BSX21

CHARACTERISTICS (continued)

$T_j = 25\text{ }^\circ\text{C}$ unless otherwise specified

Practical circuit for static operation

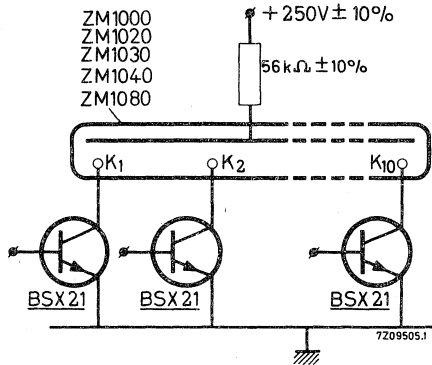

Practical circuit for dynamic operation

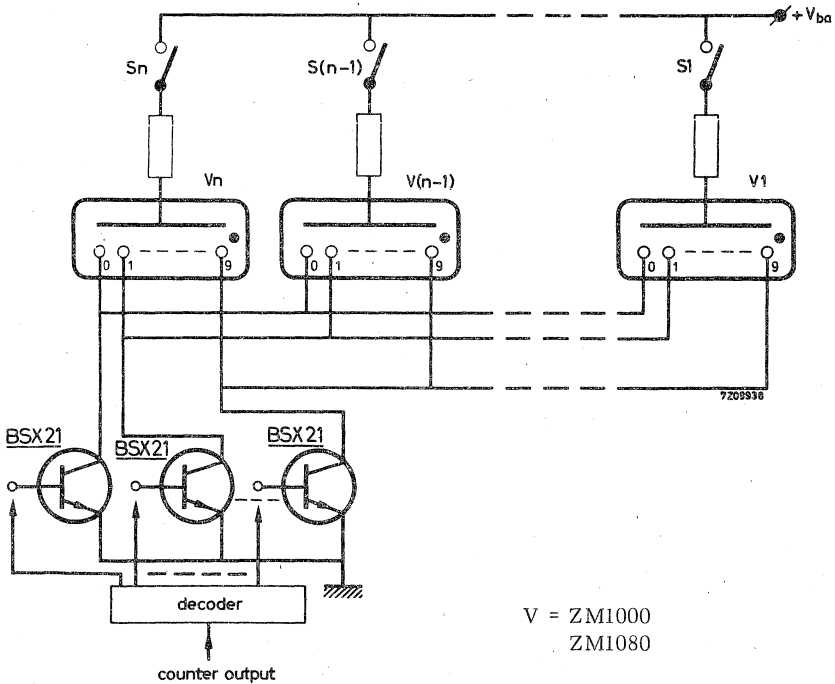

APPLICATION INFORMATION bulletins available on request

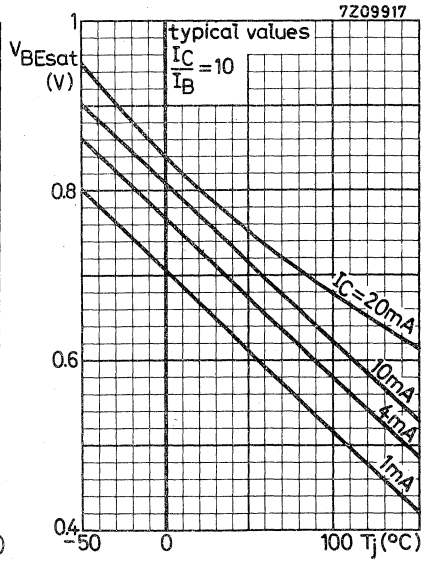
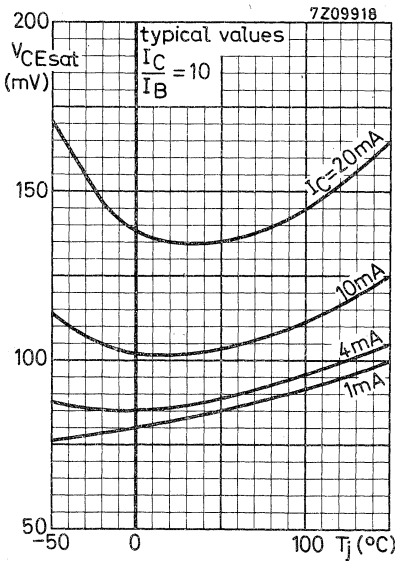
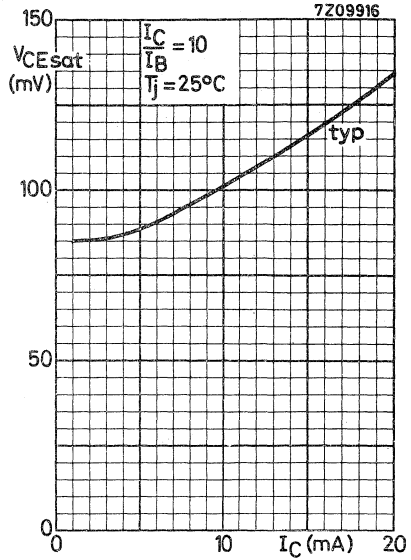
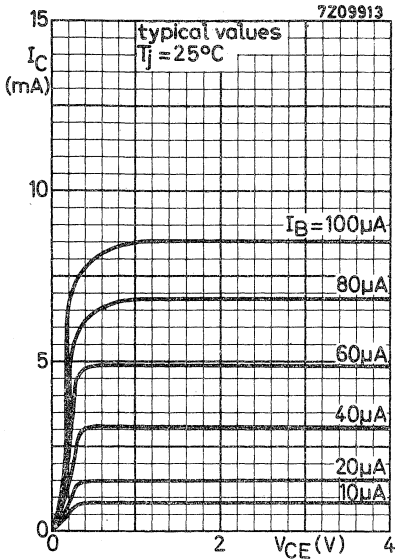

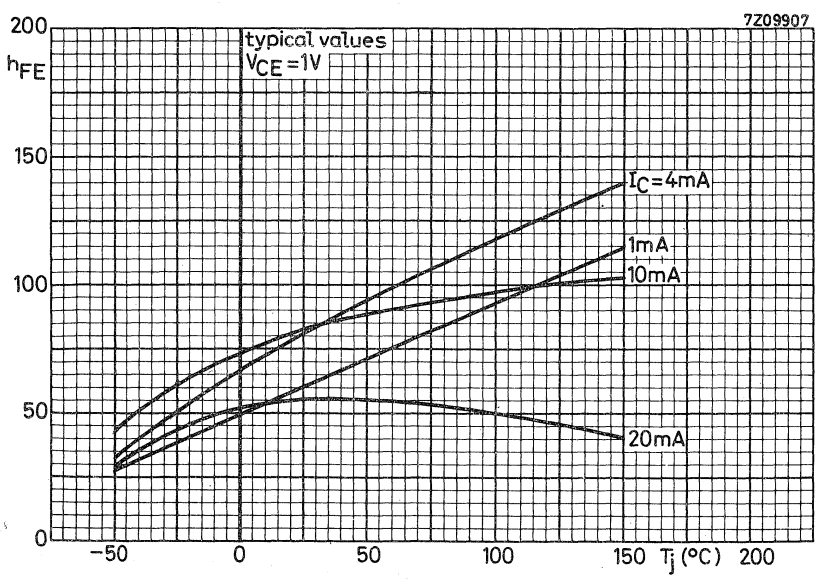
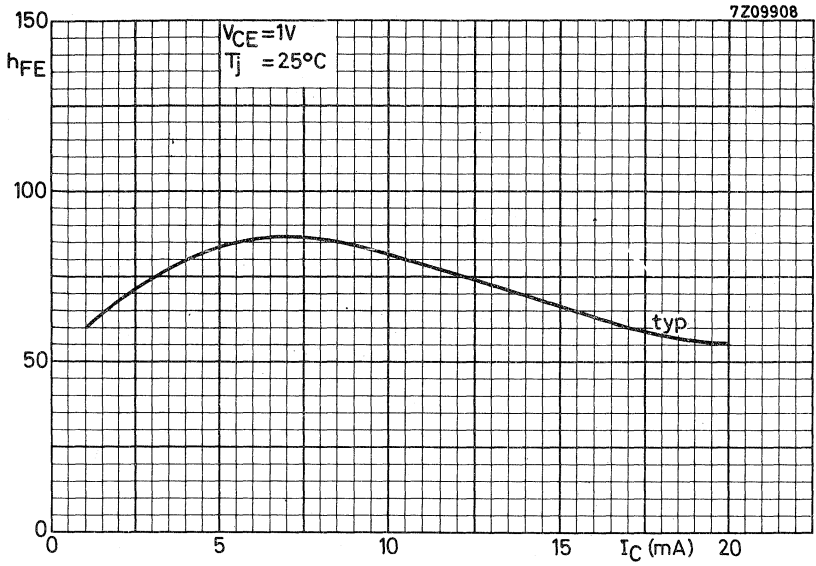

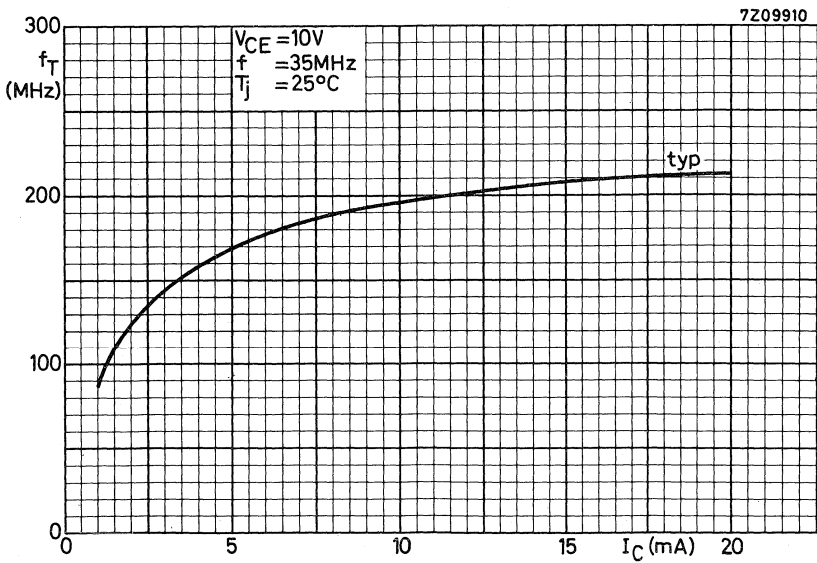
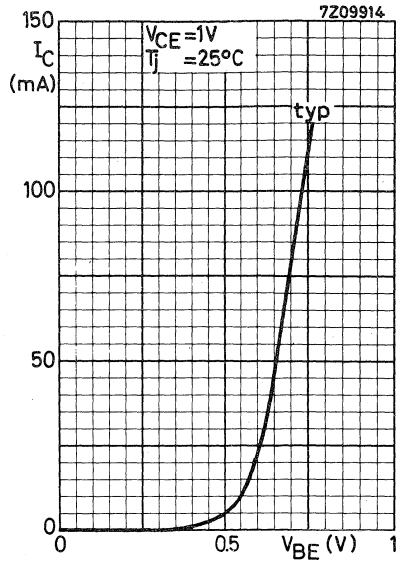
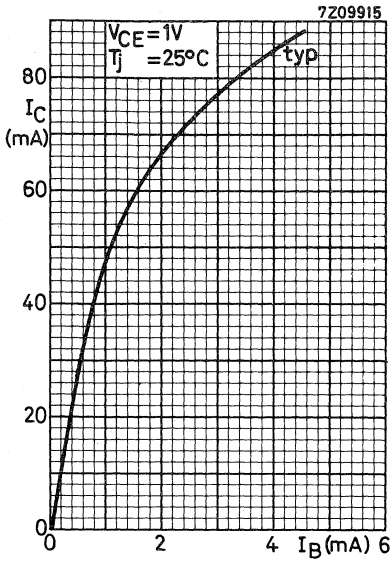

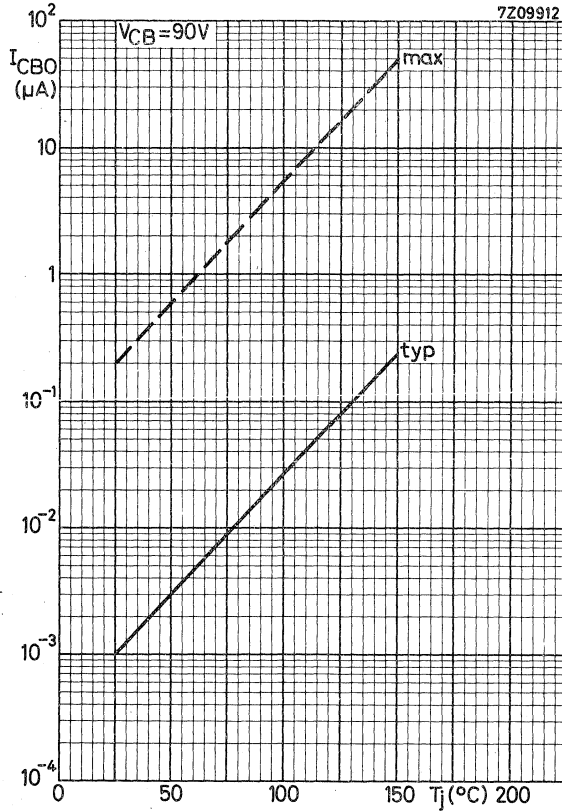

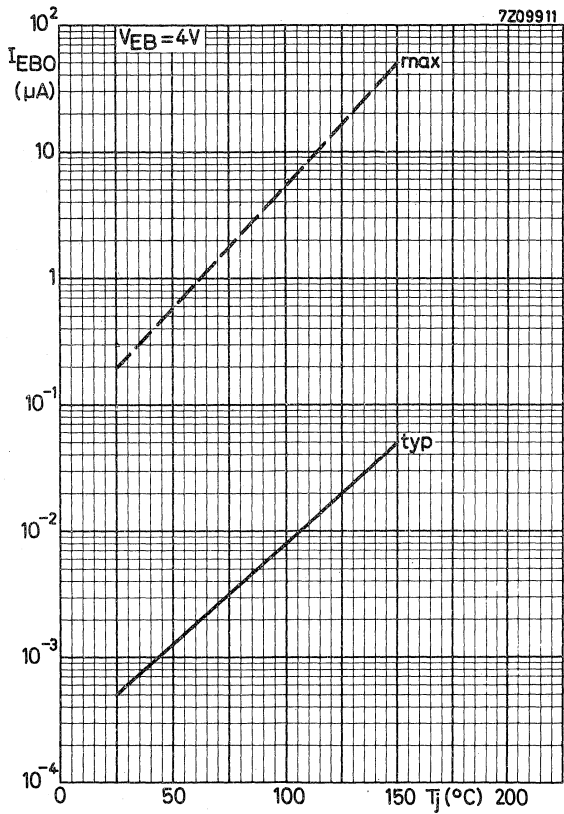

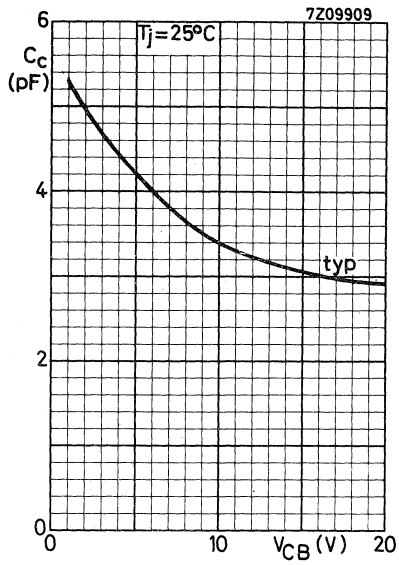
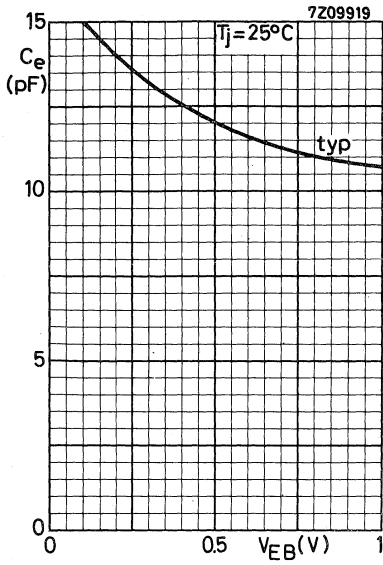

SILICON PLANAR EPITAXIAL TRANSISTORS

N-P-N transistors in a TO-39 metal envelope with the collector connected to the case. The BSX59, BSX60 and BSX61 are primarily intended for very high speed core-driving purposes.

| | | BSX59 | BSX60 | BSX61 |
|---|----------------|-------|-------|------------------------|
| Collector-base voltage (open emitter) | V_{CBO} max. | 70 | 70 | 70 V |
| Collector-emitter voltage (open base) | V_{CEO} max. | 45 | 30 | 45 V |
| Collector current (peak value) | I_{CM} max. | 1 | 1 | 1 A |
| Total power dissipation up to $T_{amb} = 25\text{ }^{\circ}\text{C}$ | P_{tot} max. | 0.8 | 0.8 | 0.8 W |
| Junction temperature | T_j max. | 200 | 200 | 200 $^{\circ}\text{C}$ |
| D.C. current gain $I_C = 500\text{ mA}; V_{CE} = 1\text{ V}$ | $h_{FE} >$ | 30 | 30 | 30 |
| Saturation voltage $I_C = 500\text{ mA}; I_B = 50\text{ mA}$ | $V_{CEsat} <$ | 0.5 | 0.5 | 0.7 V |
| Transition frequency $I_C = 50\text{ mA}; V_{CE} = 10\text{ V}$ | f_T typ. | 450 | 475 | 475 MHz |
| Turn-off time $I_C = 500\text{ mA}; I_B = 50\text{ mA}$ | $t_{off} <$ | 60 | 70 | 100 ns |

MECHANICAL DATA

Dimensions in mm

Collector connected
to case.
TO-39

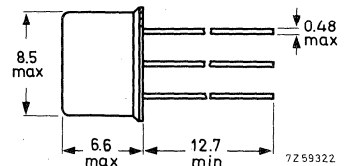
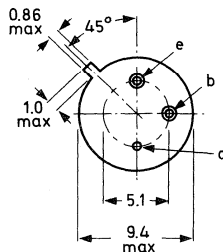

max. lead diameter is guaranteed only for 12.7 mm

Accessories available: 56218; 56245.

RATINGS Limiting values in accordance with the Absolute Maximum System (IEC 134)

Voltages

| | | BSX59 | BSX60 | BSX61 | |
|--|-----------|---------|-------|-------|---|
| Collector-base voltage (open emitter) | V_{CBO} | max. 70 | 70 | 70 | V |
| Collector-emitter voltage (open base) $I_C = 10 \text{ mA}$ | V_{CEO} | max. 45 | 30 | 45 | V |
| Emitter-base voltage (open collector) | V_{EBO} | max. 5 | 5 | 5 | V |

Currents

| | | | | |
|--------------------------------|-----------|------|---|---|
| Collector current (d.c.) | I_C | max. | 1 | A |
| Collector current (peak value) | I_{CM} | max. | 1 | A |
| Emitter current (peak value) | $-I_{EM}$ | max. | 1 | A |

Power dissipation

| | | | | |
|---|-----------|------|-----|---|
| Total power dissipation up to $T_{amb} = 25 \text{ }^\circ\text{C}$ | P_{tot} | max. | 0.8 | W |
|---|-----------|------|-----|---|

Temperatures

| | | | |
|----------------------|-----------|-------------|------------------|
| Storage temperature | T_{stg} | -65 to +200 | $^\circ\text{C}$ |
| Junction temperature | T_j | max. 200 | $^\circ\text{C}$ |

THERMAL RESISTANCE

| | | | | |
|--------------------------------------|--------------|---|-----|--------------------|
| From junction to ambient in free air | R_{thj-a} | = | 220 | $^\circ\text{C/W}$ |
| From junction to case | R_{thj-c} | = | 43 | $^\circ\text{C/W}$ |
| From junction to mounting base | R_{thj-mb} | = | 35 | $^\circ\text{C/W}$ |

CHARACTERISTICS

$T_j = 25\text{ }^\circ\text{C}$ unless otherwise specified

Collector cut-off current

| | | BSX59 | BSX60 | BSX61 | |
|--|-----------|-------|-------|-------|---------------|
| $I_E = 0; V_{CB} = 40\text{ V}$ | I_{CBO} | < 500 | 500 | 500 | nA |
| $I_E = 0; V_{CB} = 40\text{ V}; T_j = 150\text{ }^\circ\text{C}$ | I_{CBO} | < 300 | 300 | 300 | μA |

Emitter cut-off current

| | | | | | |
|---|-----------|-------|-----|-----|---------------|
| $I_C = 0; V_{EB} = 4\text{ V}$ | I_{EBO} | < 300 | 300 | 500 | nA |
| $I_C = 0; V_{EB} = 4\text{ V}; T_j = 150\text{ }^\circ\text{C}$ | I_{EBO} | < 50 | 50 | 50 | μA |

Currents at reverse biased emitter junction

| | | | | | |
|---|------------|-------|-----|------|---------------|
| $-V_{BE} = 4\text{ V}; V_{CE} = 40\text{ V}$ | $+I_{CEX}$ | < 500 | 500 | 1000 | nA |
| | $-I_{BEX}$ | < 500 | 500 | 1000 | nA |
| $-V_{BE} = 4\text{ V}; V_{CE} = 40\text{ V}; T_j = 150\text{ }^\circ\text{C}$ | $+I_{CEX}$ | < 300 | 300 | 500 | μA |
| | $-I_{BEX}$ | < 300 | 300 | 500 | μA |

Saturation voltages

| | | | | | |
|---|-------------|-----------------|------------|------------|--------|
| $I_C = 150\text{ mA}; I_B = 15\text{ mA}$ | V_{CEsat} | < 0.3 | 0.3 | 0.5 | V |
| | V_{BEsat} | < 1.0 | 1.0 | 1.0 | V |
| $I_C = 500\text{ mA}; I_B = 50\text{ mA}$ | V_{CEsat} | < 0.5 | 0.5 | 0.7 | V |
| | V_{BEsat} | > 0.85 < 1.2 | 0.7 1.3 | 0.7 1.3 | V V |
| $I_C = 1\text{ A}; I_B = 100\text{ mA}$ | V_{CEsat} | < 1.0 | 1.0 | 1.3 | V |
| | V_{BEsat} | < 1.8 | 1.8 | 1.8 | V |

D.C. current gain

| | | | | | |
|--|----------|---------|----|-----|--|
| $I_C = 150\text{ mA}; V_{CE} = 1\text{ V}$ | h_{FE} | > 30 | 30 | 30 | |
| | | typ. 70 | 90 | 105 | |
| $I_C = 500\text{ mA}; V_{CE} = 1\text{ V}$ | h_{FE} | > 30 | 30 | 30 | |
| | | < 90 | 90 | 90 | |
| $I_C = 1\text{ A}; V_{CE} = 5\text{ V}$ | h_{FE} | > 20 | 25 | 20 | |
| | | typ. 40 | 50 | 55 | |

Transition frequency

| | | | | | |
|--|-------|----------|-----|-----|-----|
| $I_C = 50\text{ mA}; V_{CE} = 10\text{ V}$ | f_T | > 250 | 250 | 250 | MHz |
| | | typ. 450 | 475 | 475 | MHz |

Collector capacitance at $f = 1\text{ MHz}$

| | | | | | |
|---------------------------------------|-------|--------|----|----|----|
| $I_E = I_e = 0; V_{CB} = 10\text{ V}$ | C_c | typ. 6 | 6 | 6 | pF |
| | | < 10 | 10 | 10 | pF |

Emitter capacitance at $f = 1\text{ MHz}$

| | | | | | |
|--|-------|---------|----|----|----|
| $I_C = I_c = 0; V_{EB} = 0.5\text{ V}$ | C_e | typ. 36 | 36 | 36 | pF |
| | | < 50 | 50 | 50 | pF |

CHARACTERISTICS (continued)

$T_j = 25\text{ }^\circ\text{C}$ unless otherwise specified

Recovered charge

$I_C = 500\text{ mA}; I_B = 50\text{ mA}$

BSX60

$Q_S < 5\text{ nC}$

Test circuit:

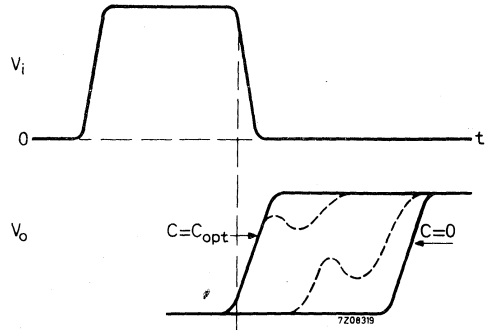
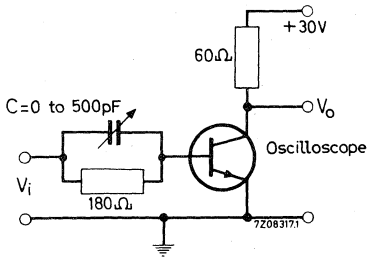

Adjust C from zero to C_{opt}

$$Q_S = C_{opt} \cdot V_i$$

Pulse generator:

Pulse duration $t_p = 10\text{ }\mu\text{s}$

Duty cycle $\delta = 0.02$

CHARACTERISTICS (continued)

$T_j = 25\text{ }^\circ\text{C}$ unless otherwise specified

Switching times (see also page 10)

Turn on time when switched from
 $-V_{BE} = 2\text{ V}$ to $I_C = 500\text{ mA}$; $I_B = 50\text{ mA}$

Turn off time when switched from
 $I_C = 500\text{ mA}$; $I_B = 50\text{ mA}$ to cut-off with
 $-I_{BM} = 50\text{ mA}$ ¹⁾

| | BSX59 | BSX60 | BSX61 |
|-----------|---------|-------|--------|
| t_{on} | typ. 17 | 17 | 18 ns |
| | < 35 | 40 | 50 ns |
| t_{off} | typ. 45 | 58 | 70 ns |
| | < 60 | 70 | 100 ns |

Test circuit:

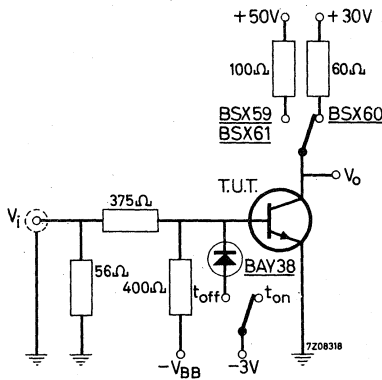

| | t_{on} | t_{off} |
|----------|----------|-----------|
| V_{BB} | 4 | 16.7 V |
| V_i | 24.75 | 37.5 V |

- Pulse generator: Pulse duration $t_p \geq 500\text{ ns}$
 Rise time $t_r \leq 5\text{ ns}$
 Fall time $t_f \leq 5\text{ ns}$
 Output resistance $R_o = 50\text{ }\Omega$ (during pulse, otherwise infinite)

¹⁾ $-I_{BM}$ is the reverse current that can flow during switching off. The indicated $-I_{BM}$ is determined and limited by the applied cut-off voltage and the series resistance.

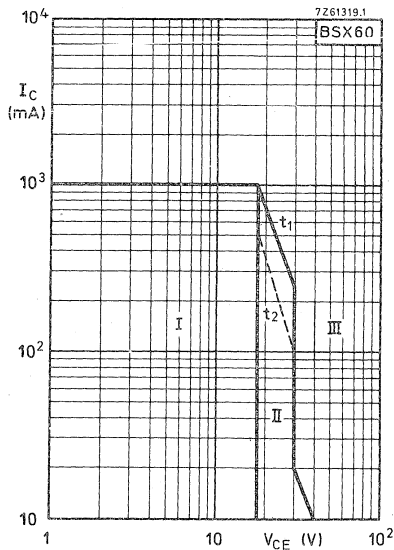
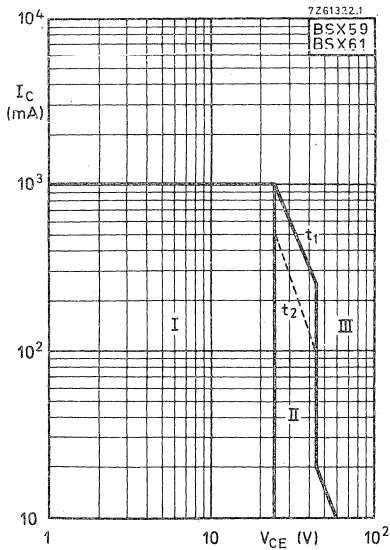
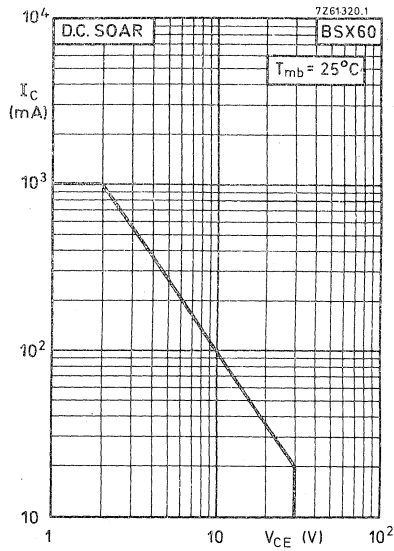
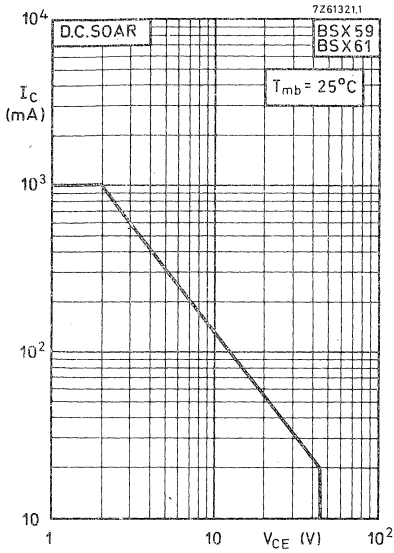

- I Region of permissible operation during switching off with $-V_{BB} = 4 \text{ V}$; $R_{BE} = 39 \Omega$
- II Permissible extension for repetitive pulsed operation.
 - t_1 limits operations with $t_p \leq 0.1 \mu\text{s}$; $\delta = 0.25$
 - t_2 limits operations with $t_p \leq 1 \mu\text{s}$; $\delta = 0.25$
- III Operation in this area is not allowed.

Typical behaviour of d.c. current gain versus I_C

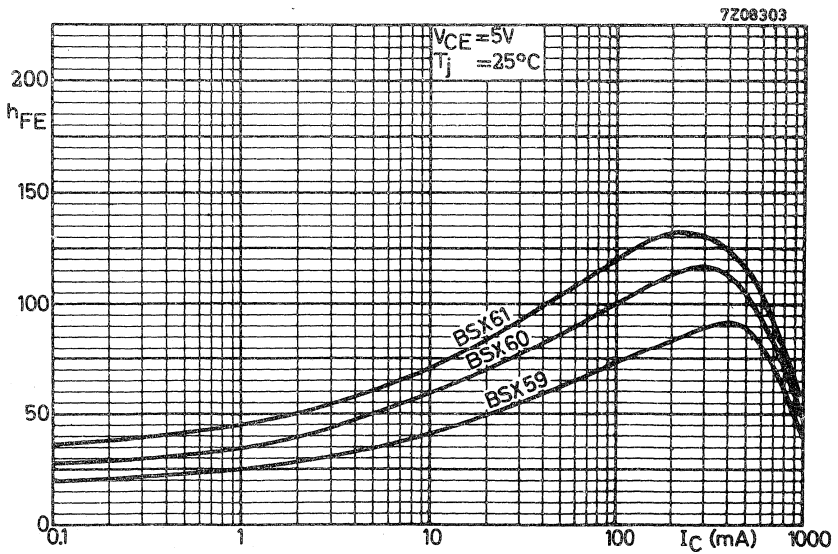
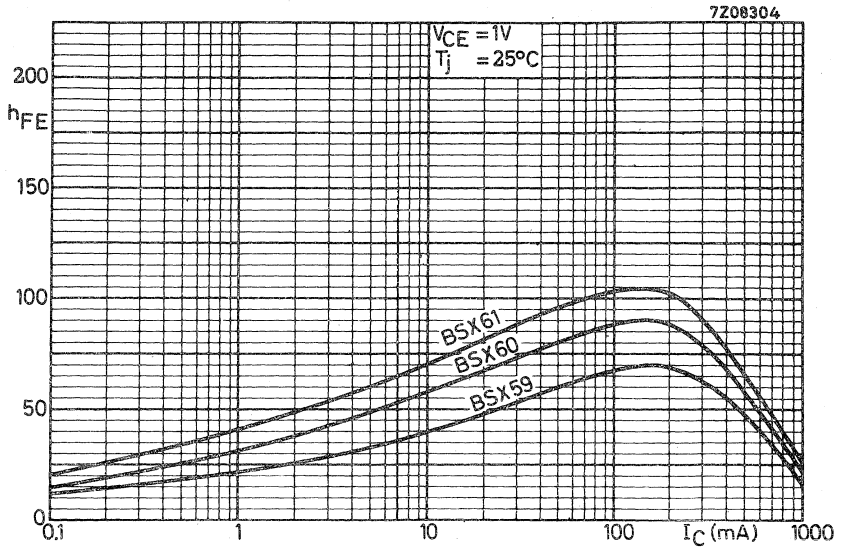

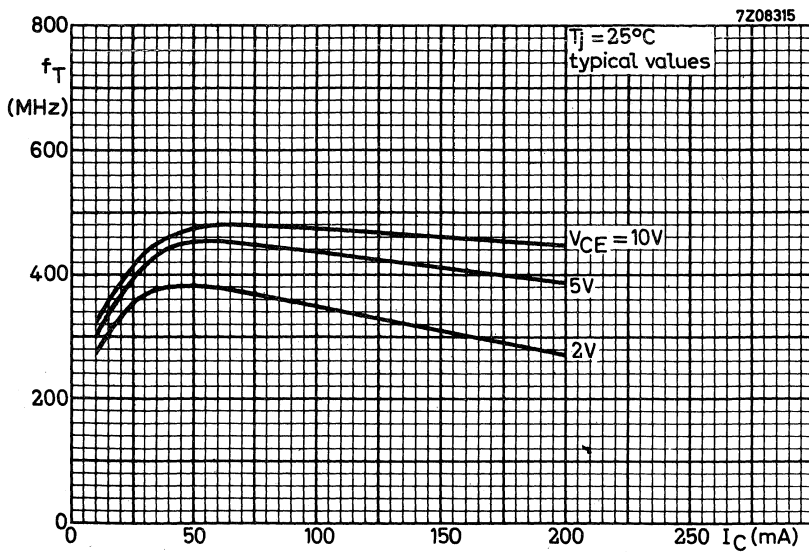
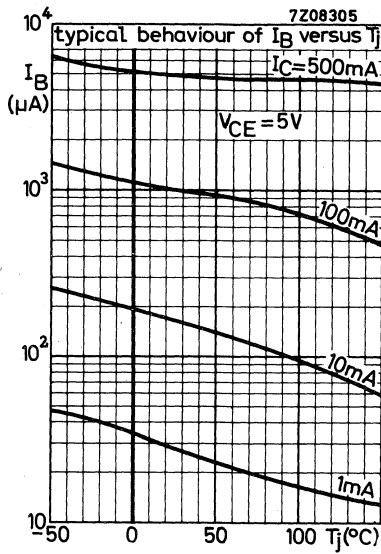

Typical behaviour of saturation voltages versus I_C

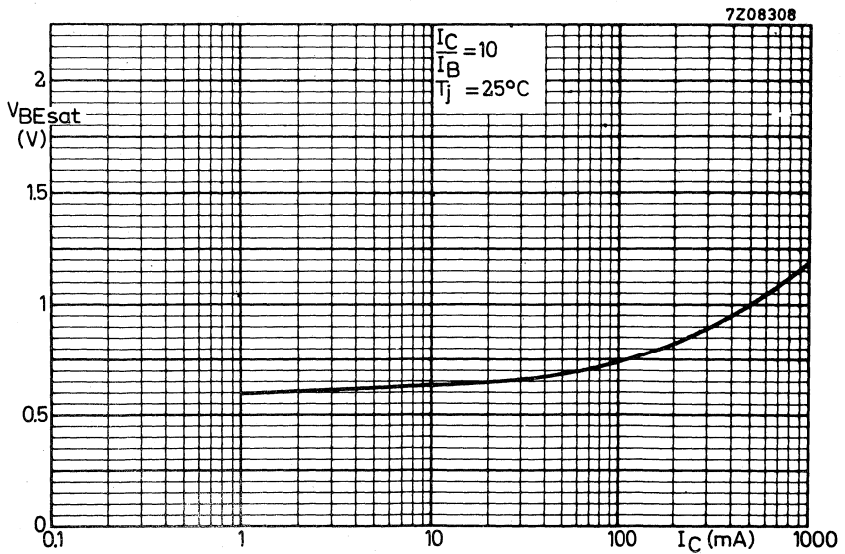
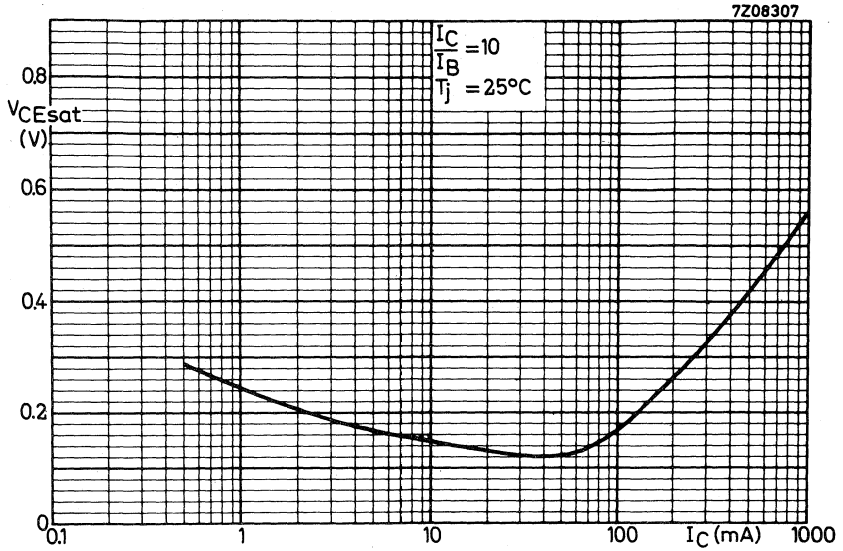

Typical behaviour of saturation voltages versus T_j

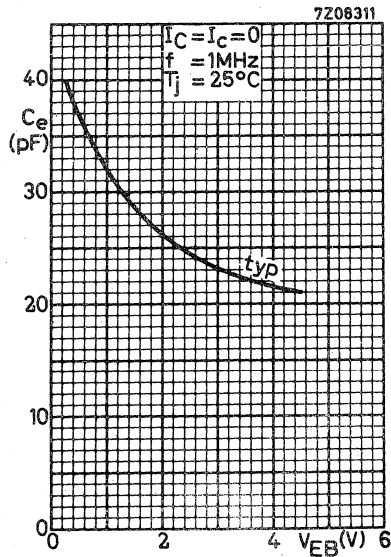
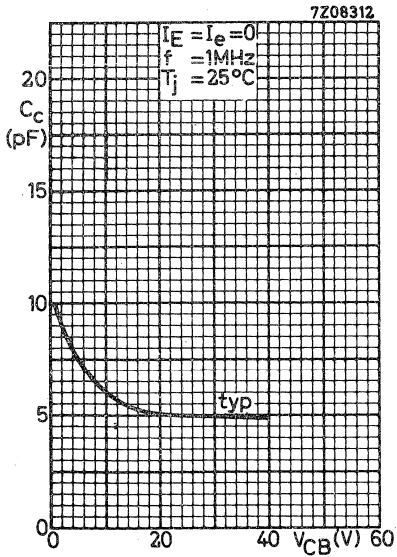
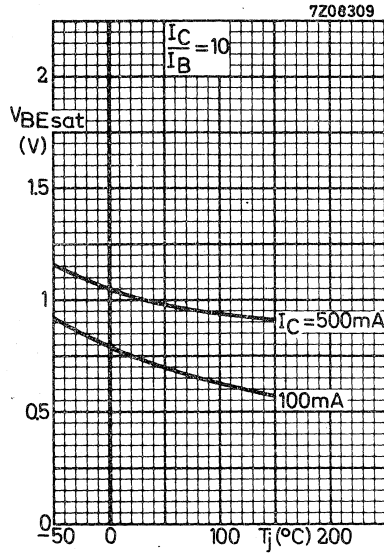
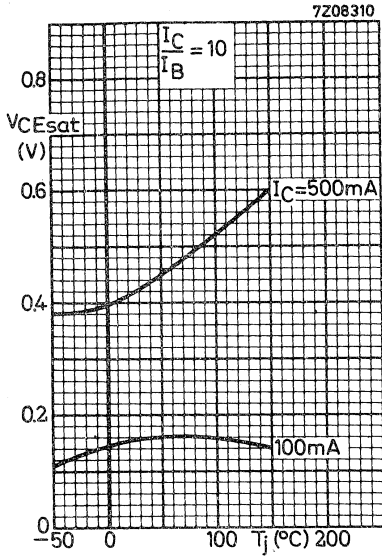

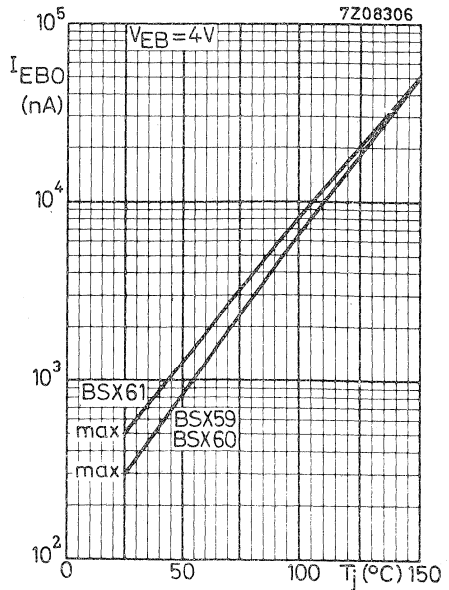
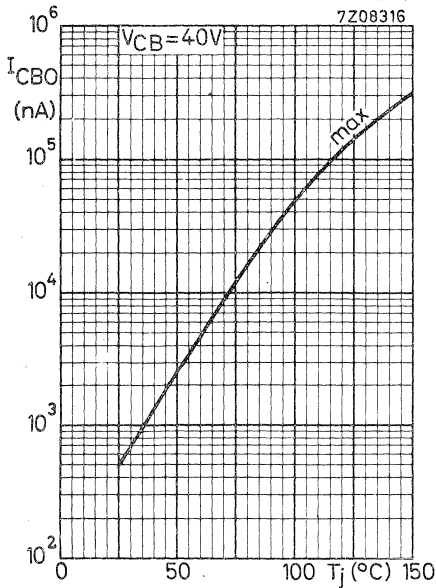
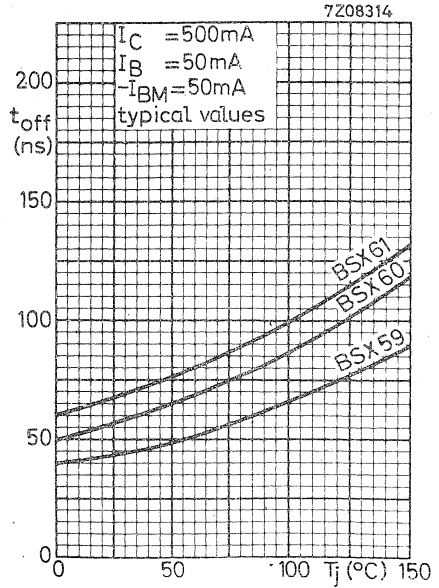
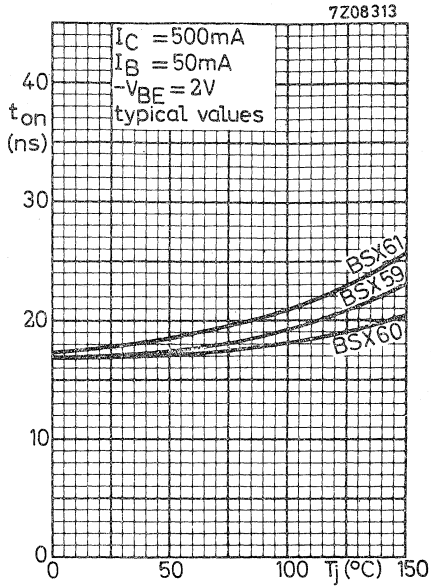

GERMANIUM ALLOYED TRANSISTORS

N-P-N transistors in a TO-5 metal envelope with the base connected to the case. These general purpose transistors are primarily intended for medium current medium speed computer logic applications.

| | | QUICK REFERENCE DATA | | | |
|---|-------------|----------------------|------|------|---------------------|
| | | 2N1302 | 1304 | 1306 | 1308 |
| Collector-base voltage (open emitter) | V_{CBO} | max. 25 | 25 | 25 | 25 V |
| Collector-emitter voltage (open base) | V_{CEO} | max. 25 | 20 | 15 | 15 V |
| Collector current (peak value) | I_{CM} | max. 300 | 300 | 300 | 300 mA |
| Total power dissipation up to $T_{amb} = 25^\circ\text{C}$ | P_{tot} | max. 150 | 150 | 150 | 150 mW |
| Junction temperature | T_j | max. 85 | 85 | 85 | 85 $^\circ\text{C}$ |
| D. C. current gain at $T_j = 25^\circ\text{C}$ $I_C = 10\text{ mA}; V_{CE} = 1\text{ V}$ | h_{FE} | > 20 | 40 | 60 | 80 |
| Saturation voltage $I_C = 10\text{ mA}; I_B = \frac{I_C}{h_{FEmin}}$ | V_{CEsat} | < 0.2 | 0.2 | 0.2 | 0.2 V |
| Transition frequency $I_C = 1\text{ mA}; V_{CE} = 5\text{ V}$ | f_T | typ. 10 | 15 | 20 | 30 MHz |
| Turn on time ($t_d + t_r$) | t_{on} | typ. 285 | 270 | 225 | 220 ns |
| Turn off time ($t_s + t_f$) | t_{off} | typ. 865 | 850 | 815 | 790 ns |

MECHANICAL DATA

Dimensions in mm

TO-5

Base connected to case.

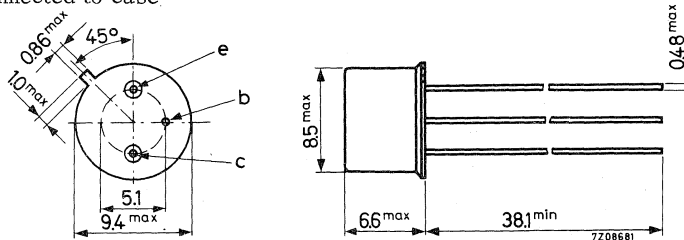

Accessories available: 56218, 56245

RATINGS (Limiting values) ¹⁾

Voltages

| | | 2N1302 | 1304 | 1306 | 1308 |
|--|----------------|--------|------|------|------|
| Collector-base voltage (open emitter) | V_{CBO} max. | 25 | 25 | 25 | 25 V |
| Collector-emitter voltage (open base) | V_{CEO} max. | 25 | 20 | 15 | 15 V |
| Emitter-base voltage (open collector) | V_{EBO} max. | 25 | 25 | 25 | 25 V |

Currents

| | | | | |
|---|----------|------|-----|----|
| Collector current (d. c. or average over any 20 ms period) | I_C | max. | 200 | mA |
| Collector current (peak value) | I_{CM} | max. | 300 | mA |

Power dissipation

| | | | | |
|--|-----------|------|-----|----|
| Total power dissipation up to $T_{amb} = 25\text{ }^\circ\text{C}$ | P_{tot} | max. | 150 | mW |
|--|-----------|------|-----|----|

Temperatures

| | | | |
|----------------------|-----------|-------------|------------------|
| Storage temperature | T_{stg} | -65 to +100 | $^\circ\text{C}$ |
| Junction temperature | T_j | max. 85 | $^\circ\text{C}$ |

THERMAL RESISTANCE

| | | | | |
|--------------------------------------|---------------|---|-----|----------------------------|
| From junction to ambient in free air | $R_{th\ j-a}$ | = | 0.4 | $^\circ\text{C}/\text{mW}$ |
| From junction to case | $R_{th\ j-c}$ | = | 0.2 | $^\circ\text{C}/\text{mW}$ |

¹⁾ Limiting values according to the Absolute Maximum System as defined in IEC publication 134.

CHARACTERISTICS

$T_j = 25\text{ }^\circ\text{C}$ unless otherwise specified

| | | 2N1302 | 1304 | 1306 | 1308 |
|---|-------------|-------------------------------|----------------------|----------------------|--------------------------------------|
| <u>Collector cut-off current</u> | | | | | |
| $I_E = 0; V_{CB} = 25\text{ V}$ | I_{CBO} | typ. 3 < 6 | 3 6 | 3 6 | 3 μA 6 μA |
| <u>Emitter cut-off current</u> | | | | | |
| $I_C = 0; V_{EB} = 25\text{ V}$ | I_{EBO} | typ. 2.2 < 6 | 2.2 6 | 2.2 6 | 2.2 μA 6 μA |
| <u>Collector current at reverse biased emitter junction</u> | | | | | |
| $-V_{BE} = 0.2\text{ V}; T_j = 55\text{ }^\circ\text{C}$ | | | | | |
| $V_{CE} = 20\text{ V}$ | I_{CEX} | < 50 | 50 | | μA |
| $V_{CE} = 15\text{ V}$ | I_{CEX} | < | | 50 | 50 μA |
| <u>Saturation voltages</u> | | | | | |
| $I_C = 10\text{ mA}; I_B = 0.5\text{ mA}$ | V_{BEsat} | > 0.15 typ. 0.30 < 0.40 | 0.15 0.25 0.35 | 0.15 0.24 0.35 | 0.15 V 0.23 V 0.35 V |
| | V_{CEsat} | typ. 0.1 < 0.2 | | | V V |
| $I_C = 10\text{ mA}; I_B = 0.25\text{ mA}$ | V_{CEsat} | typ. < | 0.1 0.2 | | V V |
| $I_C = 10\text{ mA}; I_B = 0.17\text{ mA}$ | V_{CEsat} | typ. < | | 0.1 0.2 | V V |
| $I_C = 10\text{ mA}; I_B = 0.13\text{ mA}$ | V_{CEsat} | typ. < | | | 0.1 V 0.2 V |
| <u>Punch through voltage</u> | V_{pt} | > 25 | 20 | 15 | 15 V |
| <u>D.C. current gain</u> | | | | | |
| $I_C = 10\text{ mA}; V_{CE} = 1\text{ V}$ | h_{FE} | > 20 typ. 50 < 100 | 40 70 100 | 60 100 200 | 80 150 300 |
| $I_C = 200\text{ mA}; V_{CE} = 0.35\text{ V}$ | h_{FE} | > 10 typ. 48 | 15 65 | 20 95 | 20 145 |
| <u>Collector capacitance at $f = 1\text{ MHz}$</u> | | | | | |
| $I_E = I_e = 0; V_{CB} = 5\text{ V}$ | C_c | typ. 12 < 20 | 12 20 | 12 20 | 12 pF 20 pF |
| <u>Emitter capacitance at $f = 1\text{ MHz}$</u> | | | | | |
| $I_C = I_c = 0; V_{EB} = 5\text{ V}$ | C_e | typ. 8 | 8 | 8 | 8 pF |
| <u>Transition frequency</u> | | | | | |
| $I_C = 1\text{ mA}; V_{CE} = 5\text{ V}$ | f_T | > 3 typ. 10 | 5 15 | 10 20 | 15 MHz 30 MHz |

CHARACTERISTICS (continued)

$T_j = 25^\circ\text{C}$ unless otherwise specified

Switching times

- delay time
- rise time
- storage time
- fall time

| | 2N1302 | 1304 | 1306 | 1308 | |
|-------|----------|------|------|------|----|
| t_d | typ. 65 | 60 | 55 | 55 | ns |
| t_r | typ. 220 | 210 | 170 | 165 | ns |
| t_s | typ. 500 | 500 | 500 | 500 | ns |
| t_f | typ. 365 | 350 | 315 | 290 | ns |
| Q_s | typ. 800 | 700 | 650 | 600 | pC |

Recovered charge

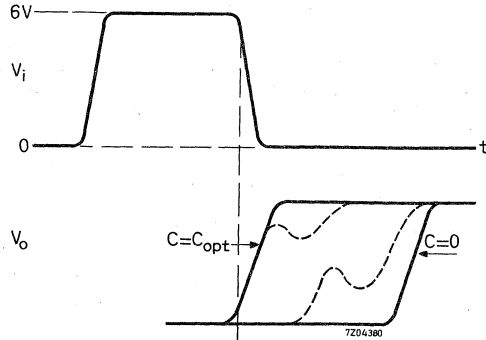
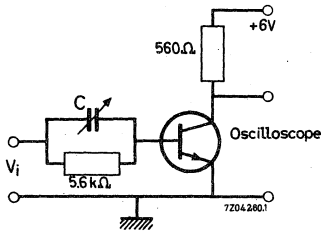
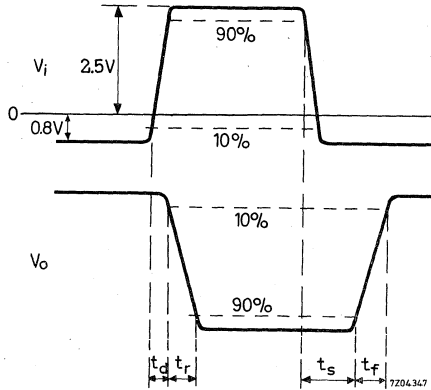
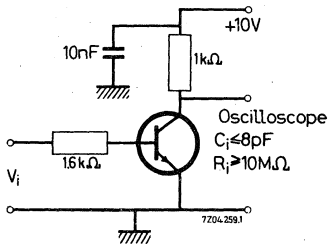

Adjust C from zero to C_{opt}
 $Q_s = C_{opt} \cdot V_i$

GERMANIUM ALLOYED TRANSISTORS

P-N-P transistors in a TO-5 metal envelope with the base connected to the case. These general purpose transistors are primarily intended for medium current medium speed computer logic applications.

| | | QUICK REFERENCE DATA | | | |
|---|-----------------|-----------------------------|------|------|---------------------|
| | | 2N1303 | 1305 | 1307 | 1309 |
| Collector-base voltage (open emitter) | $-V_{CB0}$ max. | 30 | 30 | 30 | 30 V |
| Collector-emitter voltage (open base) | $-V_{CEO}$ max. | 25 | 20 | 15 | 15 V |
| Collector current (peak value) | $-I_{CM}$ max. | 300 | 300 | 300 | 300 mA |
| Total power dissipation up to $T_{amb} = 25^\circ\text{C}$ | P_{tot} max. | 150 | 150 | 150 | 150 mW |
| Junction temperature | T_j max. | 85 | 85 | 85 | 85 $^\circ\text{C}$ |
| D. C. current gain at $T_j = 25^\circ\text{C}$ $-I_C = 10\text{ mA}; -V_{CE} = 1\text{ V}$ | h_{FE} | > 20 | 40 | 60 | 80 |
| Saturation voltage $-I_C = 10\text{ mA}; -I_B = \frac{-I_C}{h_{FEmin}}$ | $-V_{CEsat}$ | < 0.2 | 0.2 | 0.2 | 0.2 V |
| Transition frequency $-I_C = 1\text{ mA}; -V_{CE} = 5\text{ V}$ | f_T typ. | 5 | 10 | 15 | 20 MHz |
| Turn on time ($t_d + t_r$) | t_{on} typ. | 360 | 255 | 230 | 200 ns |
| Turn off time ($t_s + t_f$) | t_{off} typ. | 1300 | 1150 | 1050 | 1050 ns |

MECHANICAL DATA

Dimensions in mm

TO-5

Base connected to case

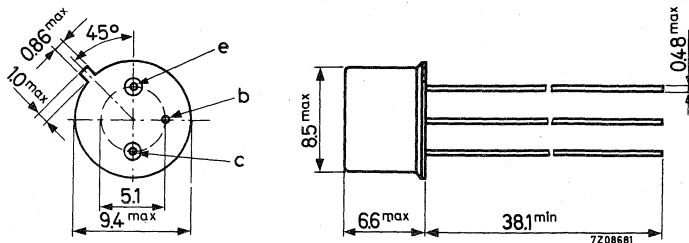

Accessories available: 56218, 56245

RATINGS (Limiting values) ¹⁾

Voltages

| | | 2N1303 | 1305 | 1307 | 1309 |
|--|-----------------|--------|------|------|------|
| Collector-base voltage (open emitter) | $-V_{CBO}$ max. | 30 | 30 | 30 | 30 V |
| Collector-emitter voltage (open base) | $-V_{CEO}$ max. | 25 | 20 | 15 | 15 V |
| Emitter-base voltage (open collector) | $-V_{EBO}$ max. | 25 | 25 | 25 | 25 V |

Currents

| | | | | |
|---|-----------|------|-----|----|
| Collector current (d. c. or average over any 20 ms period) | $-I_C$ | max. | 200 | mA |
| Collector current (peak value) | $-I_{CM}$ | max. | 300 | mA |

Power dissipation

| | | | | |
|--|-----------|------|-----|----|
| Total power dissipation up to $T_{amb} = 25\text{ }^{\circ}\text{C}$ | P_{tot} | max. | 150 | mW |
|--|-----------|------|-----|----|

Temperatures

| | | | |
|----------------------|-----------|-------------|--------------------|
| Storage temperature | T_{stg} | -65 to +100 | $^{\circ}\text{C}$ |
| Junction temperature | T_j | max. 85 | $^{\circ}\text{C}$ |

THERMAL RESISTANCE

| | | | | |
|--------------------------------------|---------------|---|-----|------------------------------|
| From junction to ambient in free air | $R_{th\ j-a}$ | = | 0.4 | $^{\circ}\text{C}/\text{mW}$ |
| From junction to case | $R_{th\ j-c}$ | = | 0.2 | $^{\circ}\text{C}/\text{mW}$ |

¹⁾ Limiting values according to the Absolute Maximum System as defined in IEC publication 134.

CHARACTERISTICS

$T_j = 25^\circ\text{C}$ unless otherwise specified

| | | 2N1303 | 1305 | 1307 | 1309 | |
|--|--------------|--------|------|------|------|-------------------|
| <u>Collector cut-off current</u> $I_E = 0; -V_{CB} = 25\text{ V}$ | $-I_{CBO}$ | typ. | 3 | 3 | 3 | 3 μA |
| | | < | 6 | 6 | 6 | 6 μA |
| <u>Emitter cut-off current</u> $I_C = 0; -V_{EB} = 25\text{ V}$ | $-I_{EBO}$ | typ. | 1.7 | 1.7 | 1.7 | 1.7 μA |
| | | < | 6 | 6 | 6 | 6 μA |
| <u>Collector current at reverse biased emitter junction</u> $-V_{CE} = 15\text{ V}; +V_{BE} = 0.2\text{ V}$ $T_j = 55^\circ\text{C}$ | $-I_{CEX}$ | < | 50 | 50 | 50 | 50 μA |
| | | > | 0.15 | 0.15 | 0.15 | 0.15 V |
| <u>Saturation voltages</u> $-I_C = 10\text{ mA}; -I_B = 0.5\text{ mA}$ | $-V_{BEsat}$ | typ. | 0.30 | 0.25 | 0.24 | 0.23 V |
| | | < | 0.40 | 0.35 | 0.35 | 0.35 V |
| | $-V_{CEsat}$ | typ. | 0.1 | | | V |
| | | < | 0.2 | | | V |
| $-I_C = 10\text{ mA}; -I_B = 0.25\text{ mA}$ | $-V_{CEsat}$ | typ. | | 0.1 | | V |
| | | < | | 0.2 | | V |
| $-I_C = 10\text{ mA}; -I_B = 0.17\text{ mA}$ | $-V_{CEsat}$ | typ. | | | 0.1 | V |
| | | < | | | 0.2 | V |
| $-I_C = 10\text{ mA}; -I_B = 0.13\text{ mA}$ | $-V_{CEsat}$ | typ. | | | | 0.1 V |
| | | < | | | | 0.2 V |
| <u>Punch through voltage</u> | V_{pt} | > | 25 | 20 | 15 | 15 V |
| <u>D. C. current gain</u> $-I_C = 10\text{ mA}; -V_{CE} = 1\text{ V}$ | hFE | > | 20 | 40 | 60 | 80 |
| | | typ. | 50 | 70 | 100 | 150 |
| | | < | | 100 | 200 | 300 |
| $-I_C = 200\text{ mA}; -V_{CE} = 0.35\text{ V}$ | hFE | > | 10 | 15 | 20 | 20 |
| | | typ. | 35 | 55 | 90 | 130 |
| <u>Collector capacitance at $f = 1\text{ MHz}$</u> $I_E = I_e = 0; -V_{CB} = 5\text{ V}$ | C_c | typ. | 10 | 10 | 10 | 10 pF |
| | | < | 20 | 20 | 20 | 20 pF |
| <u>Emitter capacitance at $f = 1\text{ MHz}$</u> $I_C = I_c = 0; -V_{EB} = 5\text{ V}$ | C_e | typ. | 7 | 7 | 7 | 7 pF |
| | | > | 3 | 5 | 10 | 15 MHz |
| <u>Transition frequency</u> $-I_C = 1\text{ mA}; -V_{CE} = 5\text{ V}$ | f_T | typ. | 5 | 10 | 15 | 20 MHz |

CHARACTERISTICS (continued)

$T_j = 25\text{ }^\circ\text{C}$

Switching times

- delay time
- rise time
- storage time
- fall time

| | 2N1303 | 1305 | 1307 | 1309 | |
|-------|-----------|------|------|------|----|
| t_d | typ. 60 | 55 | 50 | 45 | ns |
| t_r | typ. 300 | 200 | 180 | 155 | ns |
| t_s | typ. 700 | 700 | 700 | 700 | ns |
| t_f | typ. 600 | 450 | 350 | 350 | ns |
| Q_s | typ. 1000 | 1000 | 1000 | 1000 | pC |

Recovered charge

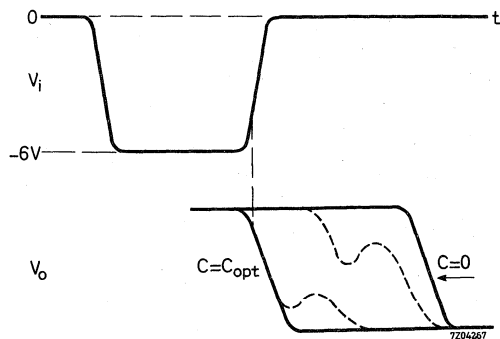
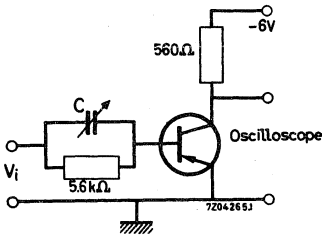
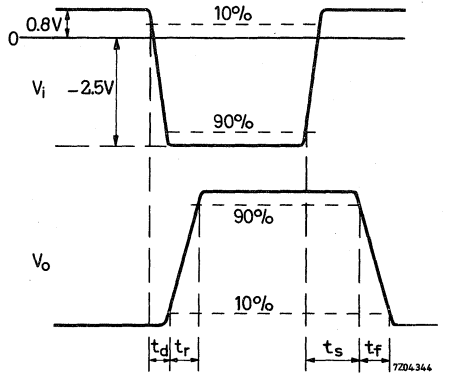
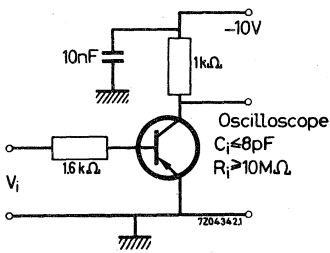

Adjust C from zero to C_{opt}
 $Q_s = C_{opt} \cdot V_i$

SILICON PLANAR EPITAXIAL TRANSISTORS

N-P-N transistors in a TO-39 metal envelope with the collector connected to the case. They are primarily intended for high speed switching. The 2N2218 is also suitable for d.c. and v.h.f. -u.h.f. amplifiers.

| | | QUICK REFERENCE DATA | |
|---|-----------|----------------------|----------------------|
| | | 2N2218 | 2N2218A |
| Collector-base voltage (open emitter) | V_{CBO} | max. 60 | 75 V |
| Collector-emitter voltage (open base) | V_{CEO} | max. 30 | 40 V |
| Collector current (d.c.) | I_C | max. 800 | 800 mA |
| Total power dissipation up to $T_{amb} = 25^\circ\text{C}$ | P_{tot} | max. 0.8 | 0.8 W |
| Junction temperature | T_j | max. 175 | 175 $^\circ\text{C}$ |
| D.C. current gain at $T_j = 25^\circ\text{C}$ $I_C = 10\text{ mA}; V_{CE} = 10\text{ V}$ | h_{FE} | > 35 | 35 |
| Transition frequency at $f = 100\text{ MHz}$ $I_C = 20\text{ mA}; V_{CE} = 20\text{ V}$ | f_T | > 250 | 250 MHz |
| Storage time $I_C = 150\text{ mA}; I_B = -I_{BM} = 15\text{ mA}$ | t_s | < - | 225 ns |

MECHANICAL DATA

Dimensions in mm

Collector connected to case
TO-39

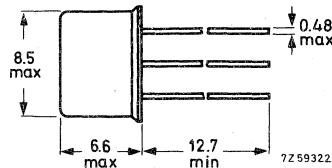
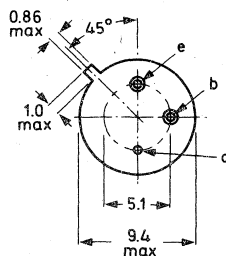

max. lead diameter is guaranteed only for 12.7 mm

Accessories available: 56218; 56245

RATINGS Limiting values in accordance with the Absolute Maximum System (IEC 134)

| <u>Voltages</u> | | 2N2218 | 2N2218A |
|---------------------------------------|-----------|---------|--------------------|
| Collector-base voltage (open emitter) | V_{CBO} | max. 60 | 75 V |
| Collector-emitter voltage (open base) | V_{CEO} | max. 30 | 40 ¹⁾ V |
| Emitter-base voltage (open collector) | V_{EBO} | max. 5 | 6 V |

Current

| | | | |
|--------------------------|-------|----------|----|
| Collector current (d.c.) | I_C | max. 800 | mA |
|--------------------------|-------|----------|----|

Power dissipation

| | | | |
|--|-----------|----------|---|
| Total power dissipation up to $T_{amb} = 25\text{ }^\circ\text{C}$ | P_{tot} | max. 0.8 | W |
| up to $T_{case} = 25\text{ }^\circ\text{C}$ | P_{tot} | max. 3 | W |

Temperatures

| | | | |
|----------------------|-----------|-------------|------------------|
| Storage temperature | T_{stg} | -65 to +200 | $^\circ\text{C}$ |
| Junction temperature | T_j | max. 175 | $^\circ\text{C}$ |

THERMAL RESISTANCE

| | | | |
|--------------------------------------|---------------|---|------------------------|
| From junction to ambient in free air | $R_{th\ j-a}$ | = | 190 $^\circ\text{C/W}$ |
| From junction to case | $R_{th\ j-c}$ | = | 50 $^\circ\text{C/W}$ |

CHARACTERISTICS

$T_j = 25\text{ }^\circ\text{C}$ unless otherwise specified

Collector-cut-off current

| | | 2N2218 | 2N2218A |
|--|-----------|--------|------------------|
| $I_E = 0; V_{CB} = 50\text{ V}$ | I_{CBO} | < 10 | - nA |
| $I_E = 0; V_{CB} = 50\text{ V}; T_{amb} = 150\text{ }^\circ\text{C}$ | I_{CBO} | < 10 | - μA |
| $I_E = 0; V_{CB} = 60\text{ V}$ | I_{CBO} | < - | 10 nA |
| $I_E = 0; V_{CB} = 60\text{ V}; T_{amb} = 150\text{ }^\circ\text{C}$ | I_{CBO} | < - | 10 μA |

Emitter cut-off current

| | | | |
|--------------------------------|-----------|------|-------|
| $I_C = 0; V_{EB} = 3\text{ V}$ | I_{EBO} | < 10 | 10 nA |
|--------------------------------|-----------|------|-------|

Currents at reverse biased emitter junction

| | | | |
|--|------------|-----|-------|
| $V_{CE} = 60\text{ V}; -V_{BE} = 3\text{ V}$ | I_{CEX} | < - | 10 nA |
| | $-I_{BEX}$ | < - | 20 nA |

1) Applicable up to $I_C = 500\text{ mA}$

CHARACTERISTICS (continued)

$T_j = 25^\circ\text{C}$ unless otherwise specified

| | | 2N2218 | 2N2218A |
|---|-----------------|-----------|-----------|
| <u>Breakdown voltages</u> | | | |
| $I_E = 0; I_C = 10 \mu\text{A}$ | $V_{(BR)CBO} >$ | 60 | 75 V |
| $I_B = 0; I_C = 10 \text{ mA}$ | $V_{(BR)CEO} >$ | 30 | 40 V |
| $I_C = 0; I_E = 10 \mu\text{A}$ | $V_{(BR)EBO} >$ | 5 | 6 V |
| <u>Saturation voltages</u> ¹⁾ | | | |
| $I_C = 150 \text{ mA}; I_B = 15 \text{ mA}$ | $V_{CEsat} <$ | 0.4 | 0.3 V |
| | $V_{BEsat} >$ | - | 0.6 V |
| | $V_{BEsat} <$ | 1.3 | 1.2 V |
| $I_C = 500 \text{ mA}; I_B = 50 \text{ mA}$ | $V_{CEsat} <$ | 1.6 | 1.0 V |
| | $V_{BEsat} <$ | 2.6 | 2.0 V |
| <u>D.C. current gain</u> | | | |
| $I_C = 0.1 \text{ mA}; V_{CE} = 10 \text{ V}$ | $h_{FE} >$ | 20 | 20 |
| $I_C = 1 \text{ mA}; V_{CE} = 10 \text{ V}$ | $h_{FE} >$ | 25 | 25 |
| $I_C = 10 \text{ mA}; V_{CE} = 10 \text{ V}$ | $h_{FE} >$ | 35 | 35 |
| $I_C = 10 \text{ mA}; V_{CE} = 10 \text{ V}; T_{amb} = -55^\circ\text{C}$ | $h_{FE} >$ | - | 15 |
| $I_C = 150 \text{ mA}; V_{CE} = 1 \text{ V}^1)$ | $h_{FE} >$ | 20 | 20 |
| $I_C = 150 \text{ mA}; V_{CE} = 10 \text{ V}^1)$ | $h_{FE} >$ | 40 to 120 | 40 to 120 |
| $I_C = 500 \text{ mA}; V_{CE} = 10 \text{ V}^1)$ | $h_{FE} >$ | 20 | 25 |
| <u>Transition frequency at $f = 100 \text{ MHz}$</u> | | | |
| $I_C = 20 \text{ mA}; V_{CE} = 20 \text{ V}$ | $f_T >$ | 250 | 250 MHz |
| <u>Collector capacitance at $f = 100 \text{ kHz}$</u> | | | |
| $I_E = I_e = 0; V_{CB} = 10 \text{ V}$ | $C_c <$ | 8 | 8 pF |
| <u>Emitter capacitance at $f = 100 \text{ kHz}$</u> | | | |
| $I_C = I_c = 0; V_{EB} = 0.5 \text{ V}$ | $C_e <$ | - | 25 pF |
| <u>Feedback time constant at $f = 31.8 \text{ MHz}$</u> | | | |
| $I_C = 20 \text{ mA}; V_{CE} = 20 \text{ V}$ | $r_b C_c <$ | - | 150 ps |

¹⁾ Pulse duration $\leq 300 \mu\text{s}$; duty cycle $\leq 2\%$.

2N2218 2N2218A

CHARACTERISTICS (continued)

$T_j = 25^\circ\text{C}$

h parameters (common emitter)

$I_C = 1\text{ mA}; V_{CE} = 10\text{ V}; f = 1\text{ kHz}$

Input impedance
Reverse voltage transfer ratio
Small signal current gain
Output admittance

2N2218A
 h_{ie} 1 to 3.5 $k\Omega$
 h_{re} < 5 10^{-4}
 h_{fe} 30 to 150
 h_{oe} 3 to 15 $\mu\Omega^{-1}$

$I_C = 10\text{ mA}; V_{CE} = 10\text{ V}; f = 1\text{ kHz}$

Input impedance
Reverse voltage transfer ratio
Small signal current gain
Output admittance

h_{ie} 0.2 to 1.0 $k\Omega$
 h_{re} < 2.5 10^{-4}
 h_{fe} 50 to 300
 h_{oe} 10 to 100 $\mu\Omega^{-1}$

$I_C = 20\text{ mA}; V_{CE} = 20\text{ V}; f = 100\text{ MHz}$

Small signal current gain

| | 2N2218 | 2N2218A |
|----------|--------|---------|
| h_{fe} | > 2.5 | 2.5 |

$I_C = 20\text{ mA}; V_{CE} = 20\text{ V}; f = 300\text{ MHz}$

Real part of input impedance

| | | |
|---------------------|------|-------------|
| $\text{Re}(h_{ie})$ | < 60 | 60 Ω |
|---------------------|------|-------------|

Switching times for 2N2218A

Turn on time when switched from
 $-V_{BE} = 0.5\text{ V}$ to $I_C = 150\text{ mA}; I_B = 15\text{ mA}$

Delay time
Rise time

t_d < 10 ns
 t_r < 25 ns

Test circuit:

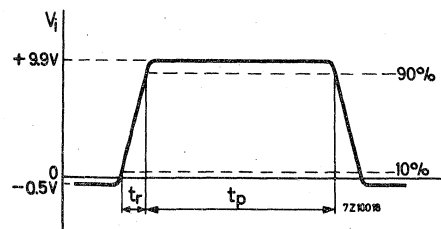

Pulse generator:

pulse duration $t_p \leq 200\text{ ns}$
rise time $t_r \leq 2\text{ ns}$

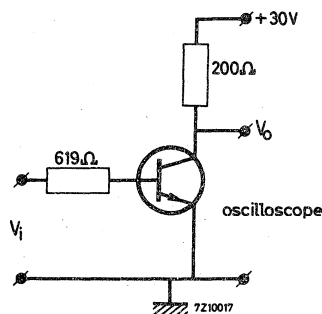

Oscilloscope:

input resistance $R_i > 100\text{ k}\Omega$
input capacitance $C_i < 12\text{ pF}$
rise time $t_r < 5\text{ ns}$

CHARACTERISTICS (continued)

$T_j = 25\text{ }^\circ\text{C}$

Switching times for 2N2218A

Turn off time

$I_C = 150\text{ mA}; I_B = -I_{BM} = 15\text{ mA}$

Storage time

$t_s < 225\text{ ns}$

Fall time

$t_f < 60\text{ ns}$

Test circuit:

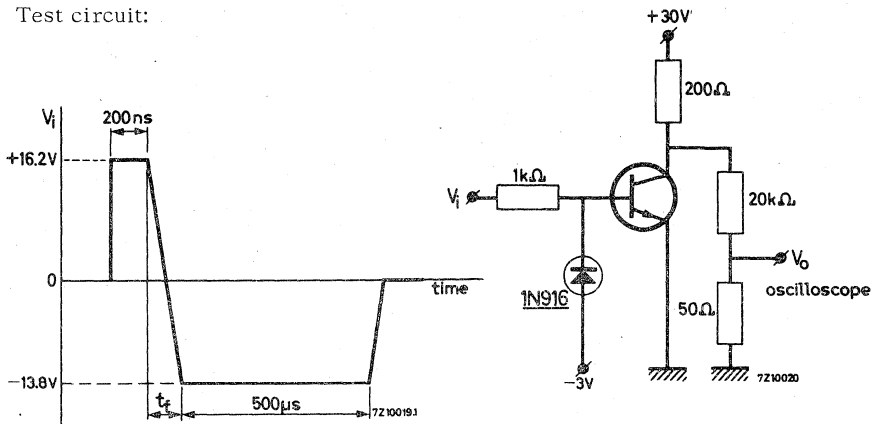

Pulse generator:

fall time $t_f < 5\text{ ns}$

Oscilloscope:

input impedance $R_i > 100\text{ k}\Omega$
input capacitance $C_i < 12\text{ pF}$
rise time $t_r < 5\text{ ns}$

SILICON PLANAR EPITAXIAL TRANSISTORS

N-P-N transistors in a TO-39 metal envelope with the collector connected to the case. They are primarily intended for high speed switching. The 2N2219 is also suitable for d. c. and v. h. f. -u. h. f. amplifiers.

| QUICK REFERENCE DATA | | | |
|---|-----------|----------|----------------|
| | | 2N2219 | 2N2219A |
| Collector-base voltage (open emitter) | V_{CBO} | max. 60 | 75 V |
| Collector-emitter voltage (open base) | V_{CEO} | max. 30 | 40 V |
| Collector current (d. c.) | I_C | max. 800 | 800 mA |
| Total power dissipation up to $T_{amb} = 25^\circ C$ | P_{tot} | max. 0.8 | 0.8 W |
| Junction temperature | T_j | max. 175 | 175 $^\circ C$ |
| D. C. current gain at $T_j = 25^\circ C$ $I_C = 10 \text{ mA}; V_{CE} = 10 \text{ V}$ | h_{FE} | > 75 | 75 |
| Transition frequency at $f = 100 \text{ MHz}$ $I_C = 20 \text{ mA}; V_{CE} = 20 \text{ V}$ | f_T | > 250 | 300 MHz |
| Storage time $I_C = 150 \text{ mA}; I_B = -I_{BM} = 15 \text{ mA}$ | t_s | > - | 225 ns |

MECHANICAL DATA

Dimensions in mm

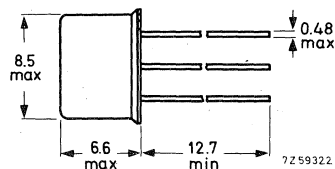
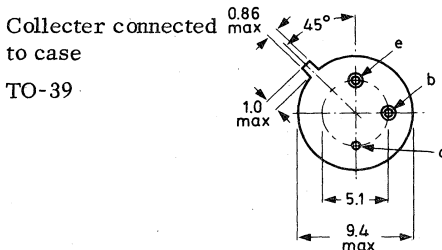

max. lead diameter is guaranteed only for 12.7 mm

Accessories available: 56218, 56245

2N2219
2N2219A

RATINGS Limiting values in accordance with the Absolute Maximum System (IEC 134)

| <u>Voltages</u> | | 2N2219 | 2N2219A |
|---------------------------------------|-----------|---------|--------------------|
| Collector-base voltage (open emitter) | V_{CBO} | max. 60 | 75 V |
| Collector-emitter voltage (open base) | V_{CEO} | max. 30 | 40 ¹⁾ V |
| Emitter-base voltage (open collector) | V_{EBO} | max. 5 | 6 V |

Current

| | | | |
|---------------------------|-------|------|--------|
| Collector current (d. c.) | I_C | max. | 800 mA |
|---------------------------|-------|------|--------|

Power dissipation

| | | | |
|--|-----------|------|-------|
| Total power dissipation up to $T_{amb} = 25\text{ }^\circ\text{C}$ | P_{tot} | max. | 0.8 W |
| up to $T_{case} = 25\text{ }^\circ\text{C}$ | P_{tot} | max. | 3 W |

Temperatures

| | | | |
|----------------------|-----------|------------------------------|----------------------|
| Storage temperature | T_{stg} | -65 to +200 $^\circ\text{C}$ | |
| Junction temperature | T_j | max. | 175 $^\circ\text{C}$ |

THERMAL RESISTANCE

| | | | |
|--------------------------------------|---------------|---|------------------------|
| From junction to ambient in free air | $R_{th\ j-a}$ | = | 190 $^\circ\text{C/W}$ |
| From junction to case | $R_{th\ j-c}$ | = | 50 $^\circ\text{C/W}$ |

CHARACTERISTICS

$T_j = 25\text{ }^\circ\text{C}$ unless otherwise specified

| <u>Collector cut-off current</u> | | 2N2219 | 2N2219A |
|--|------------|--------|------------------|
| $I_E = 0; V_{CB} = 50\text{ V}$ | I_{CBO} | < 10 | - nA |
| $I_E = 0; V_{CB} = 50\text{ V}; T_{amb} = 150\text{ }^\circ\text{C}$ | I_{CBO} | < 10 | - μA |
| $I_E = 0; V_{CB} = 60\text{ V}$ | I_{CBO} | < - | 10 nA |
| $I_E = 0; V_{CB} = 60\text{ V}; T_{amb} = 150\text{ }^\circ\text{C}$ | I_{CBO} | < - | 10 μA |
| <u>Emitter cut-off current</u> | | | |
| $I_C = 0; V_{EB} = 3\text{ V}$ | I_{EBO} | < 10 | 10 nA |
| <u>Currents at reverse biased emitter junction</u> | | | |
| $V_{CE} = 60\text{ V}; -V_{BE} = 3\text{ V}$ | I_{CEX} | < - | 10 nA |
| | $-I_{BEX}$ | < - | 20 nA |

1) Applicable up to $I_C = 500\text{ mA}$

CHARACTERISTICS (continued)

$T_j = 25^\circ\text{C}$ unless otherwise specified

Breakdown voltages

| | | 2N2219 | 2N2219A |
|---------------------------------|-----------------|--------|---------|
| $I_E = 0; I_C = 10 \mu\text{A}$ | $V_{(BR)CBO} >$ | 60 | 75 V |
| $I_B = 0; I_C = 10 \text{ mA}$ | $V_{(BR)CEO} >$ | 30 | 40 V |
| $I_C = 0; I_E = 10 \mu\text{A}$ | $V_{(BR)EBO} >$ | 5 | 6 V |

Saturation voltages ¹⁾

| | | | |
|---|---------------|-----|-------|
| $I_C = 150 \text{ mA}; I_B = 15 \text{ mA}$ | $V_{CEsat} <$ | 0.4 | 0.3 V |
| | $V_{BEsat} >$ | - | 0.6 V |
| $I_C = 500 \text{ mA}; I_B = 50 \text{ mA}$ | $V_{CEsat} <$ | 1.3 | 1.2 V |
| | $V_{BEsat} <$ | 1.6 | 1.0 V |
| | $V_{BEsat} <$ | 2.6 | 2.0 V |

D.C. current gain

| | | | |
|---|------------|------------|------------|
| $I_C = 0.1 \text{ mA}; V_{CE} = 10 \text{ V}$ | $h_{FE} >$ | 35 | 35 |
| $I_C = 1 \text{ mA}; V_{CE} = 10 \text{ V}$ | $h_{FE} >$ | 50 | 50 |
| $I_C = 10 \text{ mA}; V_{CE} = 10 \text{ V}$ | $h_{FE} >$ | 75 | 75 |
| $I_C = 10 \text{ mA}; V_{CE} = 10 \text{ V}; T_{amb} = -55^\circ\text{C}$ | $h_{FE} >$ | - | 35 |
| $I_C = 150 \text{ mA}; V_{CE} = 1 \text{ V}$ ¹⁾ | $h_{FE} >$ | 50 | 50 |
| $I_C = 150 \text{ mA}; V_{CE} = 10 \text{ V}$ ¹⁾ | h_{FE} | 100 to 300 | 100 to 300 |
| $I_C = 500 \text{ mA}; V_{CE} = 10 \text{ V}$ ¹⁾ | $h_{FE} >$ | 30 | 40 |

Transition frequency at $f = 100 \text{ MHz}$

| | | | |
|--|---------|-----|---------|
| $I_C = 20 \text{ mA}; V_{CE} = 20 \text{ V}$ | $f_T >$ | 250 | 300 MHz |
|--|---------|-----|---------|

Collector capacitance at $f = 100 \text{ kHz}$

| | | | |
|--|---------|---|------|
| $I_E = I_e = 0; V_{CB} = 10 \text{ V}$ | $C_C <$ | 8 | 8 pF |
|--|---------|---|------|

Emitter capacitance at $f = 100 \text{ kHz}$

| | | | |
|---|---------|---|-------|
| $I_C = I_c = 0; V_{EB} = 0.5 \text{ V}$ | $C_e <$ | - | 25 pF |
|---|---------|---|-------|

Feedback time constant at $f = 31.8 \text{ MHz}$

| | | | |
|--|--------------|---|--------|
| $I_C = 20 \text{ mA}; V_{CE} = 20 \text{ V}$ | $r_b' C_C <$ | - | 150 ps |
|--|--------------|---|--------|

¹⁾ Pulse duration $\leq 300 \mu\text{s}$; duty cycle $\leq 2\%$.

2N2219 2N2219A

CHARACTERISTICS (continued)

$T_j = 25\text{ }^\circ\text{C}$

h parameters (common emitter)

$I_C = 1\text{ mA}; V_{CE} = 10\text{ V}; f = 1\text{ kHz}$

Input impedance

Reverse voltage transfer ratio

Small signal current gain

Output admittance

| 2N2219A | |
|----------|--------------------------|
| h_{ie} | 2 to 8 $k\Omega$ |
| h_{re} | < 8 10^{-4} |
| h_{fe} | 50 to 300 |
| h_{oe} | 5 to 35 $\mu\Omega^{-1}$ |

$I_C = 10\text{ mA}; V_{CE} = 10\text{ V}; f = 1\text{ kHz}$

Input impedance

Reverse voltage transfer ratio

Small signal current gain

Output admittance

| | |
|----------|----------------------------|
| h_{ie} | 0.25 to 1.25 $k\Omega$ |
| h_{re} | < 4 10^{-4} |
| h_{fe} | 75 to 375 |
| h_{oe} | 25 to 200 $\mu\Omega^{-1}$ |

$I_C = 20\text{ mA}; V_{CE} = 20\text{ V}; f = 100\text{ MHz}$

Small signal current gain

$I_C = 20\text{ mA}; V_{CE} = 20\text{ V}; f = 300\text{ MHz}$

Real part of input impedance

| | 2N2219 | 2N2219A |
|---------------------|--------|-------------|
| h_{fe} | > 2.5 | 3.0 |
| $\text{Re}(h_{ie})$ | < 60 | 60 Ω |

Noise figure at $f = 1\text{ kHz}$

$I_C = 0.1\text{ mA}; V_{CE} = 10\text{ V}$

$R_G = 1\text{ k}\Omega; B = 1\text{ Hz}$

| | | |
|---|-----|------|
| F | < - | 4 dB |
|---|-----|------|

Switching times for 2N2219A

Turn on time when switched from

$-V_{BE} = 0.5\text{ V}$ to $I_C = 150\text{ mA}; I_B = 15\text{ mA}$

Delay time

Rise time

| | | |
|-------|---|-------|
| t_d | < | 10 ns |
| t_r | < | 25 ns |

Test circuit:

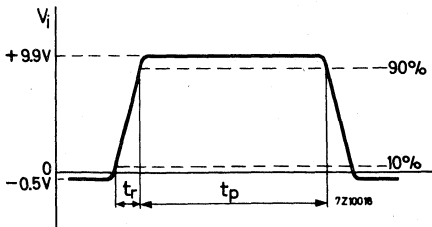

Pulse generator:

pulse duration $t_p \leq 200\text{ ns}$

rise time $t_r \leq 2\text{ ns}$

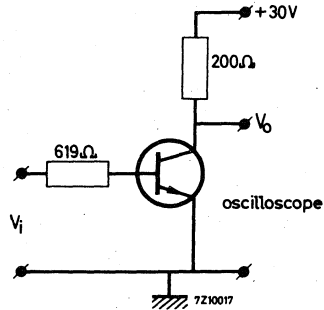

Oscilloscope:

input resistance $R_i > 100\text{ k}\Omega$

input capacitance $C_i < 12\text{ pF}$

rise time $t_r < 5\text{ ns}$

CHARACTERISTICS (continued)

$T_j = 25^\circ\text{C}$

Switching times for 2N2219A

Turn off time

$I_C = 150\text{ mA}; I_B = -I_{BM} = 15\text{ mA}$

Storage time

Fall time

Test circuit:

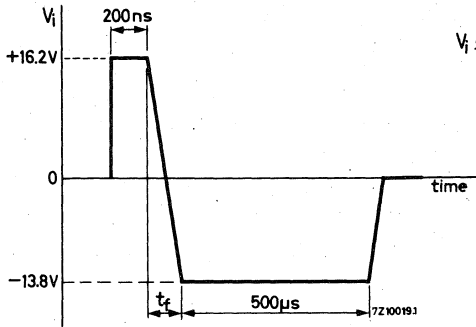

Pulse generator:

fall time $t_f < 5\text{ ns}$

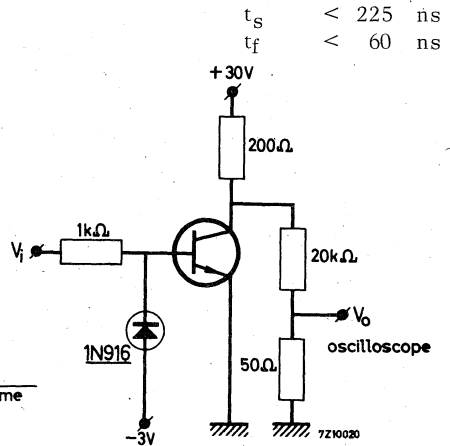

$t_s < 225\text{ ns}$
 $t_f < 60\text{ ns}$

Oscilloscope:

input impedance $R_i > 100\text{ k}\Omega$
input capacitance $C_i < 12\text{ pF}$
rise time $t_r < 5\text{ ns}$



SILICON PLANAR EPITAXIAL TRANSISTORS

N-P-N transistors in a TO-18 metal envelope with the collector connected to the case. They are primarily intended for high speed switching.

The 2N2221 is also suitable for d.c. and v.h.f. -u.h.f. amplifiers.

| | | 2N2221 | 2N2221A |
|---|----------------|--------|----------------------|
| Collector-base voltage (open emitter) | V_{CBO} max. | 60 | 75 V |
| Collector-emitter voltage (open base) | V_{CEO} max. | 30 | 40 V |
| Collector current (d.c.) | I_C max. | 800 | 800 mA |
| Total power dissipation up to $T_{amb} = 25^\circ\text{C}$ | P_{tot} max. | 0.5 | 0.5 W |
| Junction temperature | T_j max. | 175 | 175 $^\circ\text{C}$ |
| D.C. current gain at $T_j = 25^\circ\text{C}$ $I_C = 10\text{ mA}; V_{CE} = 10\text{ V}$ | h_{FE} > | 35 | 35 |
| Transition frequency at $f = 100\text{ MHz}$ $I_C = 20\text{ mA}; V_{CE} = 20\text{ V}$ | f_T > | 250 | 250 MHz |
| Storage time $I_C = 150\text{ mA}; I_B = -I_{BM} = 15\text{ mA}$ | t_s < | - | 225 ns |

MECHANICAL DATA

Dimensions in mm

Collector connected to case
TO-18

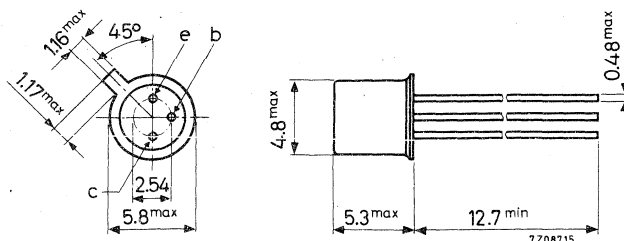

Accessories available: 56246, 56263

2N2221
2N2221A

RATINGS Limiting values in accordance with the Absolute Maximum System (IEC 134)

| <u>Voltages</u> | | 2N2221 | 2N2221A |
|---------------------------------------|-----------|---------|--------------------|
| Collector-base voltage (open emitter) | V_{CB0} | max. 60 | 75 V |
| Collector-emitter voltage (open base) | V_{CEO} | max. 30 | 40 ¹⁾ V |
| Emitter-base voltage (open collector) | V_{EBO} | max. 5 | 6 V |

Current

| | | | |
|--------------------------|-------|------|--------|
| Collector current (d.c.) | I_C | max. | 800 mA |
|--------------------------|-------|------|--------|

Power dissipation

| | | | |
|---|-----------|------|-------|
| Total power dissipation up to $T_{amb} = 25\text{ }^\circ\text{C}$ up to $T_{case} = 25\text{ }^\circ\text{C}$ | P_{tot} | max. | 0.5 W |
| | P_{tot} | max. | 1.8 W |

Temperatures

| | | | |
|----------------------|-----------|-------------|----------------------|
| Storage temperature | T_{stg} | -65 to +200 | $^\circ\text{C}$ |
| Junction temperature | T_j | max. | 175 $^\circ\text{C}$ |

THERMAL RESISTANCE

| | | | |
|--------------------------------------|---------------|---|------------------------|
| From junction to ambient in free air | $R_{th\ j-a}$ | = | 300 $^\circ\text{C/W}$ |
| From junction to case | $R_{th\ j-c}$ | = | 83 $^\circ\text{C/W}$ |

CHARACTERISTICS

$T_j = 25\text{ }^\circ\text{C}$ unless otherwise specified

| <u>Collector cut-off current</u> | | 2N2221 | 2N2221A |
|--|------------|--------|------------------|
| $I_E = 0; V_{CB} = 50\text{ V}$ | I_{CBO} | < 10 | - nA |
| $I_E = 0; V_{CB} = 50\text{ V}; T_{amb} = 150\text{ }^\circ\text{C}$ | I_{CBO} | < 10 | - μA |
| $I_E = 0; V_{CB} = 60\text{ V}$ | I_{CBO} | < - | 10 nA |
| $I_E = 0; V_{CB} = 60\text{ V}; T_{amb} = 150\text{ }^\circ\text{C}$ | I_{CBO} | < - | 10 μA |
| <u>Emitter cut-off current</u> | | | |
| $I_C = 0; V_{EB} = 3\text{ V}$ | I_{EBO} | < 10 | 10 nA |
| <u>Currents at reverse biased emitter junction</u> | | | |
| $V_{CE} = 60\text{ V}; -V_{BE} = 3\text{ V}$ | I_{CEX} | < - | 10 nA |
| | $-I_{BEX}$ | < - | 20 nA |

1) Applicable up to $I_C = 500\text{ mA}$

CHARACTERISTICS (continued)

$T_J = 25\text{ }^\circ\text{C}$ unless otherwise specified

| | | 2N2221 | 2N2221A |
|---|-----------------|-----------|-----------|
| <u>Breakdown voltages</u> | | | |
| $I_E = 0; I_C = 10\ \mu\text{A}$ | $V_{(BR)CBO} >$ | 60 | 75 V |
| $I_B = 0; I_C = 10\ \text{mA}$ | $V_{(BR)CEO} >$ | 30 | 40 V |
| $I_C = 0; I_E = 10\ \mu\text{A}$ | $V_{(BR)EBO} >$ | 5 | 6 V |
| <u>Saturation voltages ¹⁾</u> | | | |
| $I_C = 150\ \text{mA}; I_B = 15\ \text{mA}$ | $V_{CEsat} <$ | 0.4 | 0.3 V |
| | $V_{BEsat} >$ | - | 0.6 V |
| $I_C = 500\ \text{mA}; I_B = 50\ \text{mA}$ | $V_{BEsat} <$ | 1.3 | 1.2 V |
| | $V_{CEsat} <$ | 1.6 | 1.0 V |
| | $V_{BEsat} <$ | 2.6 | 2.0 V |
| | | | |
| <u>D.C. current gain</u> | | | |
| $I_C = 0.1\ \text{mA}; V_{CE} = 10\ \text{V}$ | $h_{FE} >$ | 20 | 20 |
| $I_C = 1\ \text{mA}; V_{CE} = 10\ \text{V}$ | $h_{FE} >$ | 25 | 25 |
| $I_C = 10\ \text{mA}; V_{CE} = 10\ \text{V}$ | $h_{FE} >$ | 35 | 35 |
| $I_C = 10\ \text{mA}; V_{CE} = 10\ \text{V}; T_{amb} = -55\text{ }^\circ\text{C}$ | $h_{FE} >$ | - | 15 |
| $I_C = 150\ \text{mA}; V_{CE} = 1\ \text{V} \text{ }^1)$ | $h_{FE} >$ | 20 | 20 |
| $I_C = 150\ \text{mA}; V_{CE} = 10\ \text{V} \text{ }^1)$ | h_{FE} | 40 to 120 | 40 to 120 |
| $I_C = 500\ \text{mA}; V_{CE} = 10\ \text{V} \text{ }^1)$ | $h_{FE} >$ | 20 | 25 |
| <u>Transition frequency at $f = 100\ \text{MHz}$</u> | | | |
| $I_C = 20\ \text{mA}; V_{CE} = 20\ \text{V}$ | $f_T >$ | 250 | 250 MHz |
| <u>Collector capacitance at $f = 100\ \text{kHz}$</u> | | | |
| $I_E = I_e = 0; V_{CB} = 10\ \text{V}$ | $C_c <$ | 8 | 8 pF |
| <u>Emitter capacitance at $f = 100\ \text{kHz}$</u> | | | |
| $I_C = I_c = 0; V_{EB} = 0.5\ \text{V}$ | $C_e <$ | - | 25 pF |
| <u>Feedback time constant at $f = 31.8\ \text{MHz}$</u> | | | |
| $I_C = 20\ \text{mA}; V_{CE} = 20\ \text{V}$ | $r_b' C_c <$ | - | 150 ps |

¹⁾ Pulse duration $\leq 300\ \mu\text{s}$; duty cycle $\leq 2\%$.

2N2221
2N2221A

CHARACTERISTICS (continued)

$T_j = 25\text{ }^\circ\text{C}$

h parameters (common emitter)

$I_C = 1\text{ mA}; V_{CE} = 10\text{ V}; f = 1\text{ kHz}$

Input impedance
Reverse voltage transfer ratio
Small signal current gain
Output admittance

| | | |
|----------|----------------|------------------|
| | <u>2N2221A</u> | |
| h_{ie} | 1 to 3.5 | $k\Omega$ |
| h_{re} | < 5 | 10^{-4} |
| h_{fe} | 30 to 150 | |
| h_{oe} | 3 to 15 | $\mu\Omega^{-1}$ |

$I_C = 10\text{ mA}; V_{CE} = 10\text{ V}; f = 1\text{ kHz}$

Input impedance
Reverse voltage transfer ratio
Small signal current gain
Output admittance

| | | |
|----------|------------|------------------|
| h_{ie} | 0.2 to 1.0 | $k\Omega$ |
| h_{re} | < 2.5 | 10^{-4} |
| h_{fe} | 50 to 300 | |
| h_{oe} | 10 to 100 | $\mu\Omega^{-1}$ |

$I_C = 20\text{ mA}; V_{CE} = 20\text{ V}; f = 100\text{ MHz}$

Small signal current gain

| | | |
|----------|---------------|----------------|
| | <u>2N2221</u> | <u>2N2221A</u> |
| h_{fe} | > 2.5 | 2.5 |

$I_C = 20\text{ mA}; V_{CE} = 20\text{ V}; f = 300\text{ MHz}$

Real part of input impedance

| | | | |
|--------------|------|----|----------|
| $Re(h_{ie})$ | < 60 | 60 | Ω |
|--------------|------|----|----------|

Switching times for 2N2221A

Turn on time when switched from
 $-V_{BE} - 0.5\text{ V}$ to $I_C = 150\text{ mA}; I_B = 15\text{ mA}$

Delay time
Rise time

| | | | |
|-------|---|----|----|
| t_d | < | 10 | ns |
| t_r | < | 25 | ns |

Test circuit:

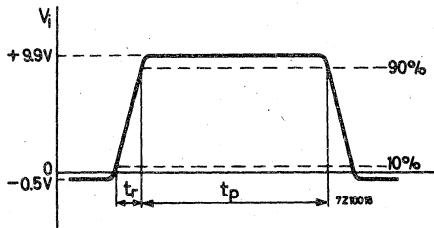

Pulse generator:
pulse duration $t_p \leq 200\text{ ns}$
rise time $t_r \leq 2\text{ ns}$

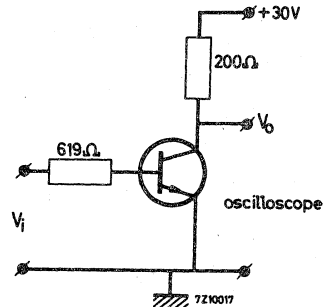

Oscilloscope:
input resistance $R_i > 100\text{ k}\Omega$
input capacitance $C_i < 12\text{ pF}$
rise time $t_r < 5\text{ ns}$

CHARACTERISTICS (continued)

$T_j = 25\text{ }^\circ\text{C}$

Switching times for 2N2221A

Turn off time

$I_C = 150\text{ mA}$; $I_B = -I_{BM} = 15\text{ mA}$

Storage time

Fall time

Test circuit:

$t_s < 225\text{ ns}$
 $t_f < 60\text{ ns}$

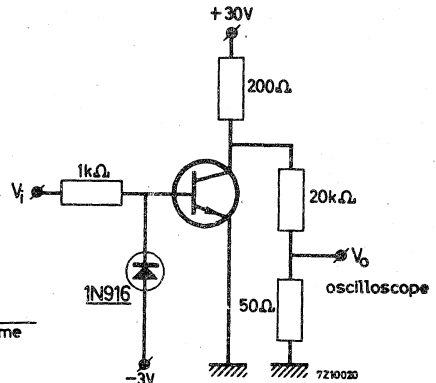
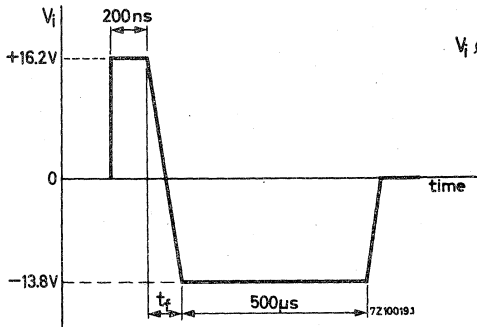

Pulse generator:

fall time $t_f < 5\text{ ns}$

Oscilloscope:

input impedance

input capacitance

rise time

$R_i > 100\text{ k}\Omega$

$C_i < 12\text{ pF}$

$t_r < 5\text{ ns}$

SILICON PLANAR EPITAXIAL TRANSISTORS

N-P-N transistors in a TO-18 metal envelope with the collector connected to the case. They are primarily intended for high speed switching. The 2N2222 is also suitable for d.c. and v.h.f. -u.h.f. amplifiers.

| QUICK REFERENCE DATA | | | |
|---|----------------|--------|----------------------|
| | | 2N2222 | 2N2222A |
| Collector-base voltage (open emitter) | V_{CBO} max. | 60 | 75 V |
| Collector-emitter voltage (open base) | V_{CEO} max. | 30 | 40 V |
| Collector current (d.c.) | I_C max. | 800 | 800 mA |
| Total power dissipation up to $T_{amb} = 25^\circ\text{C}$ | P_{tot} max. | 0.5 | 0.5 W |
| Junction temperature | T_j max. | 175 | 175 $^\circ\text{C}$ |
| D.C. current gain at $T_j = 25^\circ\text{C}$ $I_C = 10\text{ mA}; V_{CE} = 10\text{ V}$ | h_{FE} > | 75 | 75 |
| Transition frequency at $f = 100\text{ MHz}$ $I_C = 20\text{ mA}; V_{CE} = 20\text{ V}$ | f_T > | 250 | 300 MHz |
| Storage time $I_C = 150\text{ mA}; I_B = -I_{BM} = 15\text{ mA}$ | t_s < | - | 225 ns |

MECHANICAL DATA

Dimensions in mm

Collector connected to case
TO-18

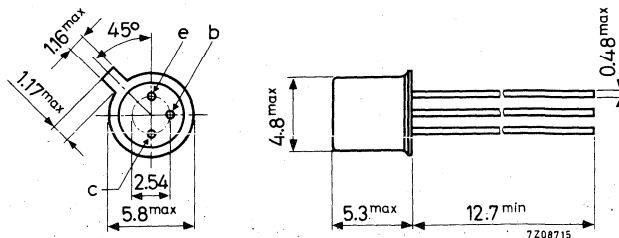

Accessories available: 56246, 56263

CHARACTERISTICS (continued)

$T_j = 25\text{ }^\circ\text{C}$ unless otherwise specified

| | | 2N2222 | 2N2222A |
|---|-----------------|------------|------------|
| <u>Breakdown voltages</u> | | | |
| $I_E = 0; I_C = 10\text{ }\mu\text{A}$ | $V_{(BR)CBO} >$ | 60 | 75 V |
| $I_B = 0; I_C = 10\text{ mA}$ | $V_{(BR)CEO} >$ | 30 | 40 V |
| $I_C = 0; I_E = 10\text{ }\mu\text{A}$ | $V_{(BR)EBO} >$ | 5 | 6 V |
| <u>Saturation voltages</u> ¹⁾ | | | |
| $I_C = 150\text{ mA}; I_B = 15\text{ mA}$ | $V_{CEsat} <$ | 0.4 | 0.3 V |
| | $V_{BEsat} >$ | - | 0.6 V |
| $I_C = 500\text{ mA}; I_B = 50\text{ mA}$ | $V_{BEsat} <$ | 1.3 | 1.2 V |
| | $V_{CEsat} <$ | 1.6 | 1.0 V |
| | $V_{BEsat} <$ | 2.6 | 2.0 V |
| <u>D.C. current gain</u> | | | |
| $I_C = 0.1\text{ mA}; V_{CE} = 10\text{ V}$ | $h_{FE} >$ | 35 | 35 |
| $I_C = 1\text{ mA}; V_{CE} = 10\text{ V}$ | $h_{FE} >$ | 50 | 50 |
| $I_C = 10\text{ mA}; V_{CE} = 10\text{ V}$ | $h_{FE} >$ | 75 | 75 |
| $I_C = 10\text{ mA}; V_{CE} = 10\text{ V}; T_{amb} = -55\text{ }^\circ\text{C}$ | $h_{FE} >$ | - | 35 |
| $I_C = 150\text{ mA}; V_{CE} = 1\text{ V}$ ¹⁾ | $h_{FE} >$ | 50 | 50 |
| $I_C = 150\text{ mA}; V_{CE} = 10\text{ V}$ ¹⁾ | h_{FE} | 100 to 300 | 100 to 300 |
| $I_C = 500\text{ mA}; V_{CE} = 10\text{ V}$ ¹⁾ | $h_{FE} >$ | 30 | 40 |
| <u>Transition frequency at $f = 100\text{ MHz}$</u> | | | |
| $I_C = 20\text{ mA}; V_{CE} = 20\text{ V}$ | $f_T >$ | 250 | 300 MHz |
| <u>Collector capacitance at $f = 100\text{ kHz}$</u> | | | |
| $I_E = I_e = 0; V_{CB} = 10\text{ V}$ | $C_c <$ | 8 | 8 pF |
| <u>Emitter capacitance at $f = 100\text{ kHz}$</u> | | | |
| $I_C = I_c = 0; V_{EB} = 0.5\text{ V}$ | $C_e <$ | - | 25 pF |
| <u>Feedback time constant at $f = 31.8\text{ MHz}$</u> | | | |
| $I_C = 20\text{ mA}; V_{CE} = 20\text{ V}$ | $r_b C_c <$ | - | 150 ps |

¹⁾ Pulse duration $\leq 300\text{ }\mu\text{s}$; duty cycle $\leq 2\%$.

2N2222
2N2222A

CHARACTERISTICS (continued)

$T_j = 25\text{ }^\circ\text{C}$

h parameters (common emitter)

$I_C = 1\text{ mA}; V_{CE} = 10\text{ V}; f = 1\text{ kHz}$

Input impedance
Reverse voltage transfer ratio
Small signal current
Output admittance

| | | |
|----------|-----------|------------------|
| h_{ie} | 2 to 8 | $k\Omega$ |
| h_{re} | < 8 | 10^{-4} |
| h_{fe} | 50 to 300 | |
| h_{oe} | 5 to 35 | $\mu\Omega^{-1}$ |

$I_C = 10\text{ mA}; V_{CE} = 10\text{ V}; f = 1\text{ kHz}$

Input impedance
Reverse voltage transfer ratio
Small signal current gain
Output admittance

| | | |
|----------|--------------|------------------|
| h_{ie} | 0.25 to 1.25 | $k\Omega$ |
| h_{re} | < 4 | 10^{-4} |
| h_{fe} | 75 to 375 | |
| h_{oe} | 25 to 200 | $\mu\Omega^{-1}$ |

$I_C = 20\text{ mA}; V_{CE} = 20\text{ V}; f = 100\text{ MHz}$

Small signal current gain

| | 2N2222 | 2N2222A |
|----------|--------|---------|
| h_{fe} | > 2.5 | 3.0 |

$I_C = 20\text{ mA}; V_{CE} = 20\text{ V}; f = 300\text{ MHz}$

Real part of input impedance

| | | |
|--------------|------|-------------|
| $Re(h_{ie})$ | < 60 | 60 Ω |
|--------------|------|-------------|

Noise figure at $f = 1\text{ kHz}$

$I_C = 0.1\text{ mA}; V_{CE} = 10\text{ V}$

$R_G = 1\text{ k}\Omega; B = 1\text{ Hz}$

| | | |
|---|-----|------|
| F | < - | 4 dB |
|---|-----|------|

Switching times for 2N2222A

Turn on time when switched from
 $-V_{BE} = 0.5\text{ V}$ to $I_C = 150\text{ mA}; I_B = 15\text{ mA}$

Delay time
Rise time

| | | |
|-------|------|----|
| t_d | < 10 | ns |
| t_r | < 25 | ns |

Test circuit:

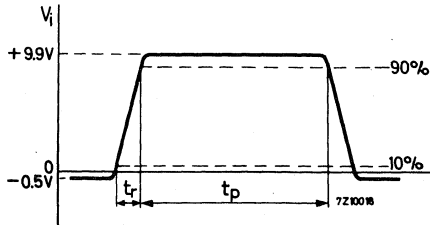

Pulse generator:

pulse duration $t_p \leq 200\text{ ns}$
rise time $t_r \leq 2\text{ ns}$

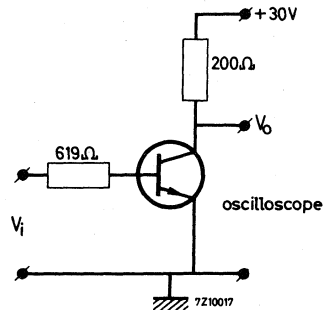

Oscilloscope:

input resistance $R_i > 100\text{ k}\Omega$
input capacitance $C_i < 12\text{ pF}$
rise time $t_r < 5\text{ ns}$

CHARACTERISTICS (continued)

$T_j = 25\text{ }^\circ\text{C}$

Switching times for 2N2222A.

Turn off time

$I_C = 150\text{ mA}; I_B = -I_{BM} = 15\text{ mA}$

Storage time

$t_s < 225\text{ ns}$

Fall time

$t_f < 60\text{ ns}$

Test circuit:

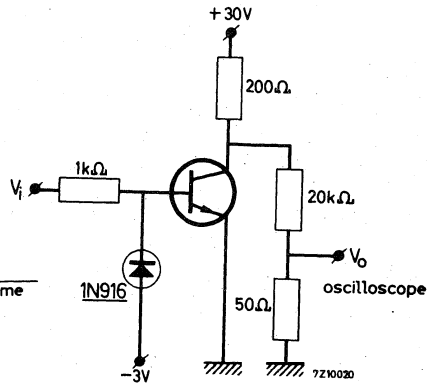
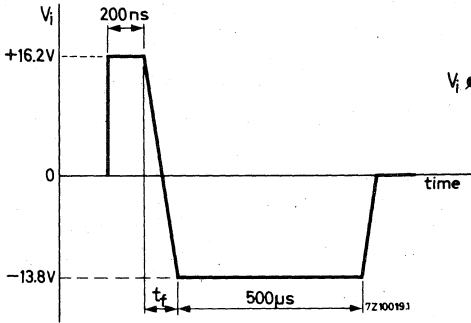

Pulse generator:

fall time

$t_f < 5\text{ ns}$

Oscilloscope:

input impedance

$R_i > 100\text{ k}\Omega$

input capacitance

$C_i < .12\text{ pF}$

rise time

$t_r < 5\text{ ns}$

SILICON PLANAR EPITAXIAL TRANSISTORS

N-P-N transistors in a TO-18 metal envelope with the collector connected to the case. The 2N2368 and 2N2369 are primarily intended for use in very high-speed saturated switching and v.h.f. amplification.

| QUICK REFERENCE DATA | | | |
|--|---------------|----------|----------------------|
| Collector-base voltage (open emitter) | V_{CBO} | max. | 40 V |
| Collector-emitter voltage (open base) | V_{CEO} | max. | 15 V |
| Collector current (peak value) | I_{CM} | max. | 500 mA |
| Total power dissipation up to $T_{amb} = 25^\circ\text{C}$ | P_{tot} | max. | 360 mW |
| Junction temperature | T_j | max. | 200 $^\circ\text{C}$ |
| D.C. current gain at $T_j = 25^\circ\text{C}$ | | | |
| $I_C = 10\text{ mA}; V_{CE} = 1\text{ V}$ | <u>2N2368</u> | h_{FE} | 20 to 60 |
| | <u>2N2369</u> | h_{FE} | 40 to 120 |
| Transition frequency | | | |
| $I_C = 10\text{ mA}; V_{CE} = 10\text{ V}$ | <u>2N2368</u> | f_T | > 400 MHz |
| | <u>2N2369</u> | f_T | > 500 MHz |
| Storage time | | | |
| $I_C = I_B = -I_{BM} = 10\text{ mA}$ | <u>2N2368</u> | t_s | < 10 ns |
| | <u>2N2369</u> | t_s | < 13 ns |

MECHANICAL DATA

Dimensions in mm

Collector connected to case

TO-18

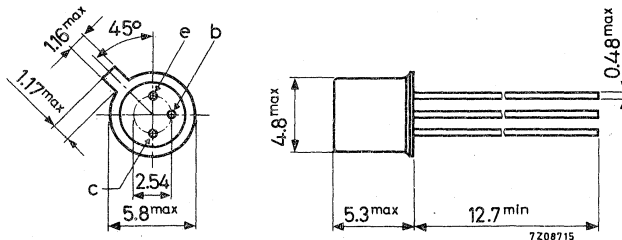

Accessories available: 56246, 56263

RATINGS (Limiting values) ¹⁾

Voltages

| | | | |
|---|-----------|------|-------|
| Collector-base voltage (open emitter) | V_{CBO} | max. | 40 V |
| Collector-emitter voltage (open base) | V_{CEO} | max. | 15 V |
| Collector-emitter voltage with $V_{BE} = 0$ | V_{CES} | max. | 40 V |
| Emitter-base voltage (open collector) | V_{EBO} | max. | 4.5 V |

Current

| | | | |
|---|----------|------|--------|
| Collector current (peak value; $t = 10 \mu s$) | I_{CM} | max. | 500 mA |
|---|----------|------|--------|

Power dissipation

| | | | |
|--|-----------|------|--------|
| Total power dissipation up to $T_{amb} = 25^\circ C$ | P_{tot} | max. | 360 mW |
|--|-----------|------|--------|

Temperatures

| | | | |
|----------------------|-----------|-------------|----------------|
| Storage temperature | T_{stg} | -65 to +200 | $^\circ C$ |
| Junction temperature | T_j | max. | 200 $^\circ C$ |

THERMAL RESISTANCE

| | | | |
|--------------------------------------|--------------|---|---------------------|
| From junction to ambient in free air | $R_{th j-a}$ | = | 0.48 $^\circ C/mW$ |
| From junction to case | $R_{th j-c}$ | = | 0.145 $^\circ C/mW$ |

¹⁾ Limiting values according to the Absolute Maximum System as defined in IEC publication 134.

CHARACTERISTICS

$T_j = 25\text{ }^\circ\text{C}$ unless otherwise specified

Collector cut-off current

$I_E = 0; V_{CB} = 20\text{ V}$

$I_{CBO} < 0.4\text{ }\mu\text{A}$

$I_E = 0; V_{CB} = 20\text{ V}; T_j = 150\text{ }^\circ\text{C}$

$I_{CBO} < 30\text{ }\mu\text{A}$

Sustaining voltage ¹⁾

$I_C = 10\text{ mA}; I_B = 0$

$V_{CEOsust} > 15\text{ V}$ ¹⁾

Saturation voltages

$I_C = 10\text{ mA}; I_B = 1\text{ mA}$

$V_{CEsat} < 0.25\text{ V}$

$V_{BEsat} 0.7\text{ to }0.85\text{ V}$

Collector capacitance at $f = 140\text{ kHz}$

$I_E = I_e = 0; V_{CB} = 5\text{ V}$

$C_C < 4\text{ pF}$

D.C. current gain ¹⁾

$I_C = 10\text{ mA}; V_{CE} = 1\text{ V}$

| | 2N2368 | 2N2369 |
|----------|----------|-----------|
| h_{FE} | 20 to 60 | 40 to 120 |

$I_C = 10\text{ mA}; V_{CE} = 1\text{ V}; T_j = -55\text{ }^\circ\text{C}$

$h_{FE} > 10$ 20

$I_C = 100\text{ mA}; V_{CE} = 2\text{ V}$

$h_{FE} > 10$ 20

Transition frequency

$I_C = 10\text{ mA}; V_{CE} = 10\text{ V}$

$f_T > 400$ 500 MHz

¹⁾ Measured under pulsed conditions to avoid excessive dissipation
Pulse duration $t = 300\text{ }\mu\text{s}$; duty cycle $\delta = 0.01$

CHARACTERISTICS (continued)

$T_j = 25\text{ }^\circ\text{C}$

Storage time

$I_C = I_B = -I_{BM} = 10\text{ mA}$

Test circuit: 1)

2N2368

2N2369

$t_S < 10\text{ ns}$

$t_S < 13\text{ ns}$

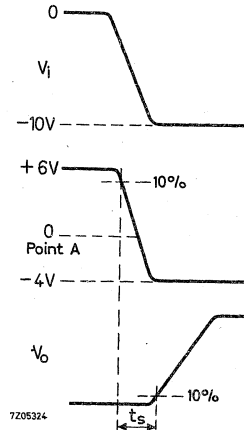
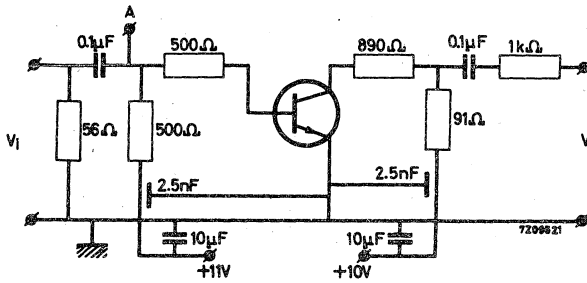

Turn on time

$I_C = 10\text{ mA}; I_B = 3\text{ mA}; -V_{BE} = 1.5\text{ V}$

Turn off time

$I_C = 10\text{ mA}; I_B = 3\text{ mA}; -I_{BM} = 1.5\text{ mA}$

Test circuit: 1)

2N2368

2N2369

$t_{on} < 12\text{ ns}$

$t_{off} < 15\text{ ns}$

$t_{off} < 18\text{ ns}$

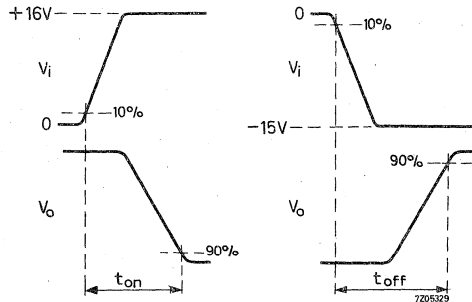
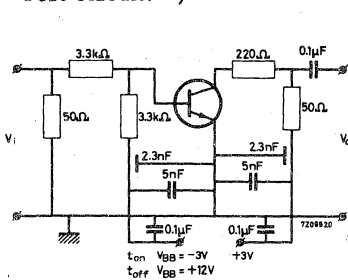

1) Pulse generator:

| | |
|------------------|------------------------|
| Pulse duration | $t \geq 300\text{ ns}$ |
| Duty cycle | $\delta \leq 0.02$ |
| Rise time | $t_r \leq 1\text{ ns}$ |
| Source impedance | $R_S = 50\ \Omega$ |

Oscilloscope:

| | |
|-----------------|------------------------|
| Rise time | $t_r \leq 1\text{ ns}$ |
| Input impedance | $R_i = 50\ \Omega$ |

SILICON PLANAR EPITAXIAL TRANSISTOR

N-P-N transistor in a TO-18 metal envelope with the collector connected to the case. The 2N2369A is primarily intended for low-power very high-speed saturated switching applications in industrial service.

| QUICK REFERENCE DATA | | |
|--|-----------|---------------------------|
| Collector-base voltage (open emitter) | V_{CBO} | max. 40 V |
| Collector-emitter voltage (open base) | V_{CEO} | max. 15 V |
| Collector current (peak value) | I_{CM} | max. 500 mA |
| Total power dissipation up to $T_{amb} = 25^\circ\text{C}$ | P_{tot} | max. 360 mW |
| Junction temperature | T_j | max. 200 $^\circ\text{C}$ |
| D.C. current gain at $T_j = 25^\circ\text{C}$ $I_C = 10\text{ mA}; V_{CE} = 1\text{ V}$ | h_{FE} | 40 to 120 |
| Transition frequency $I_C = 10\text{ mA}; V_{CE} = 10\text{ V}$ | f_T | > 500 MHz |
| Storage time $I_C = I_B = -I_{BM} = 10\text{ mA}$ | t_s | < 13 ns |

MECHANICAL DATA

Dimensions in mm

Collector connected to the case

TO-18

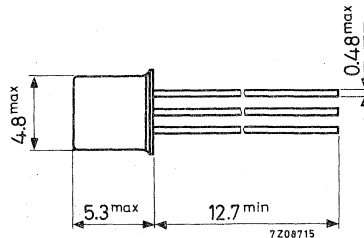
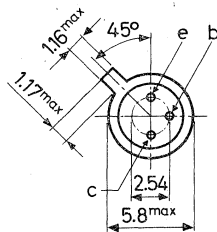

Accessories available: 56246, 56263

RATINGS (Limiting values) ¹⁾

Voltages

| | | | |
|--|-----------|------|-------|
| Collector-base voltage (open emitter) | V_{CB0} | max. | 40 V |
| Collector-emitter voltage (open base) $I_C = 0.01$ to 10 mA | V_{CEO} | max. | 15 V |
| Collector-emitter voltage with $V_{BE} = 0$ | V_{CES} | max. | 40 V |
| Emitter-base voltage (open collector) | V_{EBO} | max. | 4.5 V |

Currents

| | | | |
|---|----------|------|--------|
| Collector currents (d.c. or average over any 20 ms period) | I_C | max. | 200 mA |
| Collector current (peak value; $t = 10 \mu s$) | I_{CM} | max. | 500 mA |

Power dissipation

| | | | |
|--|-----------|------|--------|
| Total power dissipation up to $T_{amb} = 25^\circ C$ | P_{tot} | max. | 360 mW |
|--|-----------|------|--------|

Temperatures

| | | | |
|----------------------|-----------|-------------|----------------|
| Storage temperature | T_{stg} | -65 to +200 | $^\circ C$ |
| Junction temperature | T_j | max. | 200 $^\circ C$ |

THERMAL RESISTANCE

| | | | |
|--------------------------------------|--------------|---|---------------------|
| From junction to ambient in free air | $R_{th j-a}$ | = | 0.48 $^\circ C/mW$ |
| From junction to case | $R_{th j-c}$ | = | 0.145 $^\circ C/mW$ |

¹⁾ Limiting values according to the Absolute Maximum System as defined in IEC publication 134.

CHARACTERISTICS

$T_j = 25\text{ }^\circ\text{C}$ unless otherwise specified

Collector cut-off current

| | | | |
|--|-----------|---|-------------------|
| $V_{BE} = 0; V_{CE} = 20\text{ V}$ | I_{CES} | < | 0.4 μA |
| $I_E = 0; V_{CB} = 20\text{ V}; T_j = 150\text{ }^\circ\text{C}$ | I_{CBO} | < | 30 μA |

Base current

| | | | |
|------------------------------------|------------|---|-------------------|
| $V_{BE} = 0; V_{CE} = 20\text{ V}$ | $-I_{BEX}$ | < | 0.4 μA |
|------------------------------------|------------|---|-------------------|

Sustaining voltage 1)

| | | | |
|-------------------------------|----------------------|---|------|
| $I_C = 10\text{ mA}; I_B = 0$ | $V_{CEO\text{sust}}$ | > | 15 V |
|-------------------------------|----------------------|---|------|

Saturation voltages

| | | | |
|---|--------------------|---|---------------|
| $I_C = 10\text{ mA}; I_B = 1\text{ mA}$ | $V_{CE\text{sat}}$ | < | 0.2 V |
| | $V_{BE\text{sat}}$ | | 0.7 to 0.85 V |

| | | | |
|---|--------------------|---|--------|
| $I_C = 30\text{ mA}; I_B = 3\text{ mA}$ | $V_{CE\text{sat}}$ | < | 0.25 V |
| | $V_{BE\text{sat}}$ | < | 1.15 V |

| | | | |
|---|--------------------|---|-------|
| $I_C = 100\text{ mA}; I_B = 10\text{ mA}$ | $V_{CE\text{sat}}$ | < | 0.5 V |
| | $V_{BE\text{sat}}$ | < | 1.6 V |

| | | | |
|--|--------------------|---|--------|
| $I_C = 10\text{ mA}; I_B = 1\text{ mA}; T_j = 125\text{ }^\circ\text{C}$ | $V_{CE\text{sat}}$ | < | 0.3 V |
| | $V_{BE\text{sat}}$ | > | 0.59 V |

| | | | |
|--|--------------------|---|--------|
| $I_C = 10\text{ mA}; I_B = 1\text{ mA}; T_j = -55\text{ }^\circ\text{C}$ | $V_{BE\text{sat}}$ | < | 1.02 V |
|--|--------------------|---|--------|

D.C. current gain 1)

| | | | |
|---|----------|--|-----------|
| $I_C = 10\text{ mA}; V_{CE} = 1\text{ V}$ | h_{FE} | | 40 to 120 |
|---|----------|--|-----------|

| | | | |
|---|----------|---|----|
| $I_C = 30\text{ mA}; V_{CE} = 0.4\text{ V}$ | h_{FE} | > | 30 |
|---|----------|---|----|

| | | | |
|--|----------|---|----|
| $I_C = 100\text{ mA}; V_{CE} = 1\text{ V}$ | h_{FE} | > | 20 |
|--|----------|---|----|

| | | | |
|--|----------|---|----|
| $I_C = 10\text{ mA}; V_{CE} = 1\text{ V}; T_j = -55\text{ }^\circ\text{C}$ | h_{FE} | > | 20 |
|--|----------|---|----|

Collector capacitance at $f = 140\text{ kHz}$

| | | | |
|--------------------------------------|-------|---|------|
| $I_E = I_e = 0; V_{CB} = 5\text{ V}$ | C_c | < | 4 pF |
|--------------------------------------|-------|---|------|

Transition frequency

| | | | |
|--|-------|---|---------|
| $I_C = 10\text{ mA}; V_{CE} = 10\text{ V}$ | f_T | > | 500 MHz |
|--|-------|---|---------|

1) Measured under pulsed conditions to avoid excessive dissipation
Pulse duration $t = 300\text{ }\mu\text{s}$; duty cycle $\delta < 0.01$

CHARACTERISTICS (continued)

$T_j = 25\text{ }^\circ\text{C}$

Storage time

$I_C = I_B = -I_{BM} = 10\text{ mA}$

Test circuit: 1)

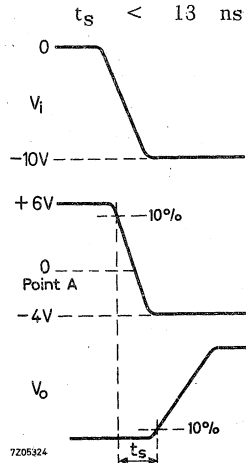
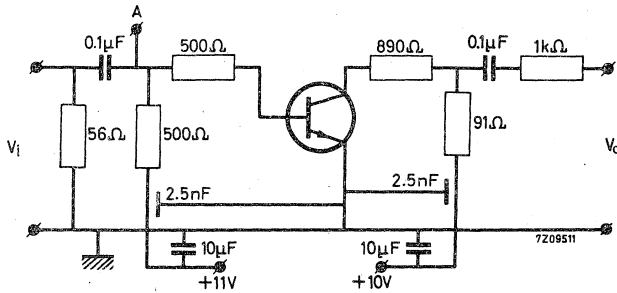

Turn on time

$I_C = 10\text{ mA}; I_B = 3\text{ mA}; -V_{BE} = 1.5\text{ V}$

Turn off time

$I_C = 10\text{ mA}; I_B = 3\text{ mA}; -I_{BM} = 1.5\text{ mA}$

Test circuit: 1)

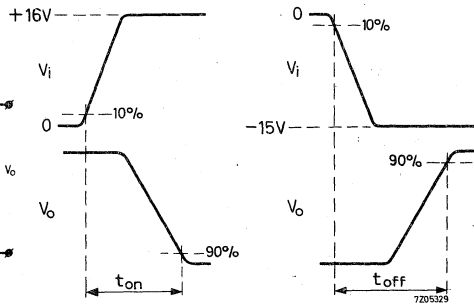
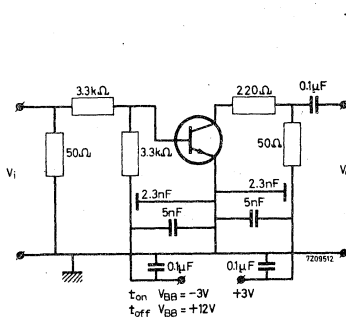

1) Pulse generator:

| | |
|------------------|--------------------------|
| Pulse duration | $t \geq 300\text{ ns}$ |
| Duty cycle | $\delta \leq 0.02$ |
| Rise time | $t_r \leq 1\text{ ns}$ |
| Source impedance | $R_S = 50\text{ }\Omega$ |

Oscilloscope:

| | |
|-----------------|--------------------------|
| Rise time | $t_r \leq 1\text{ ns}$ |
| Input impedance | $R_i = 50\text{ }\Omega$ |

SILICON LOW POWER SWITCHING TRANSISTORS

P-N-P transistors in a TO-18 metal envelope with the collector connected to the case. The 2N2894 is intended for medium speed, while the 2N2894A is intended for high speed, saturated switching applications for industrial service.

| QUICK REFERENCE DATA | | | |
|---|------------|------|--------------------------------|
| Collector-base voltage (open emitter) | $-V_{CBO}$ | max. | 12 V |
| Collector-emitter voltage (open base) | $-V_{CEO}$ | max. | 12 V |
| Collector current (d. c.) | $-I_C$ | max. | 200 mA |
| Total power dissipation up to $T_{amb} = 25^\circ\text{C}$ | P_{tot} | max. | 360 mW |
| Junction temperature | T_j | max. | 200 $^\circ\text{C}$ |
| D. C. current gain at $T_{amb} = 25^\circ\text{C}$ $-I_C = 30 \text{ mA}; -V_{CE} = 0.5 \text{ V}$ | h_{FE} | > | 40 |
| | | | <u>2N2894</u> <u>2N2894A</u> |
| Turn-off time $-I_C = 30 \text{ mA}; -I_{B1} = +I_{B2} = 1.5 \text{ mA}$ | t_{off} | < | 90 35 ns |

MECHANICAL DATA

Dimensions in mm

Collector connected to case
TO-18

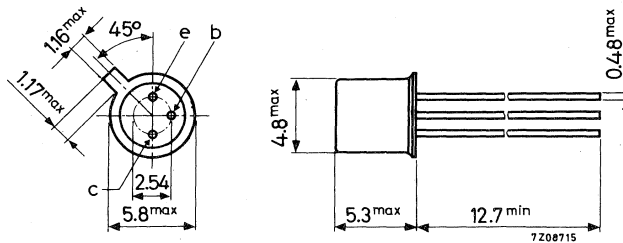

Accessories supplied on request: 56246, 56263

RATINGS Limiting values in accordance with the Absolute Maximum System (IEC134)

| <u>Voltages</u> | | 2N2894 | 2N2894A |
|---------------------------------------|------------|----------|--------------------|
| Collector-base voltage (open emitter) | $-V_{CBO}$ | max. 12 | 12 V |
| Collector-emitter voltage (open base) | $-V_{CEO}$ | max. 12 | 12 V ¹⁾ |
| Emitter-base voltage (open collector) | $-V_{EBO}$ | max. 4.0 | 4.5 V |

Current

| | | | |
|---------------------------|--------|----------|----|
| Collector current (d. c.) | $-I_C$ | max. 200 | mA |
|---------------------------|--------|----------|----|

Power dissipation

| | | | |
|--|-----------|-----------|---|
| Total power dissipation up to $T_{amb} = 25\text{ }^\circ\text{C}$ | P_{tot} | max. 0.36 | W |
| up to $T_{case} = 25\text{ }^\circ\text{C}$ | P_{tot} | max. 1.2 | W |

Temperatures

| | | | |
|----------------------|-----------|-------------|------------------|
| Storage temperature | T_{stg} | -65 to +200 | $^\circ\text{C}$ |
| Junction temperature | T_j | max. 200 | $^\circ\text{C}$ |

THERMAL RESISTANCE

| | | | |
|--------------------------------------|---------------|-------|--------------------|
| From junction to ambient in free air | $R_{th\ j-a}$ | = 486 | $^\circ\text{C/W}$ |
| From junction to case | $R_{th\ j-c}$ | = 146 | $^\circ\text{C/W}$ |

CHARACTERISTICS

$T_{amb} = 25\text{ }^\circ\text{C}$ unless otherwise specified

| <u>Collector cut-off current</u> | | 2N2894 | 2N2894A |
|--|------------|--------|------------------|
| $I_E = 0; -V_{CB} = 6.0\text{ V}; T_{amb} = 125\text{ }^\circ\text{C}$ | $-I_{CBO}$ | < 10 | - μA |
| $I_E = 0; -V_{CB} = 10\text{ V}; T_{amb} = 125\text{ }^\circ\text{C}$ | $-I_{CBO}$ | < - | 10 μA |
| $V_{BE} = 0; -V_{CE} = 6.0\text{ V}$ | $-I_{CES}$ | < 80 | - nA |
| $V_{BE} = 0; -V_{CE} = 10\text{ V}$ | $-I_{CES}$ | < - | 50 nA |

Breakdown voltages

| | | | |
|--|----------------|-------|-------|
| $I_E = 0; -I_C = 10\text{ }\mu\text{A}$ | $-V_{(BR)CBO}$ | > 12 | 12 V |
| $V_{BE} = 0; -I_C = 10\text{ }\mu\text{A}$ | $-V_{(BR)CES}$ | > 12 | 12 V |
| $I_C = 0; -I_E = 100\text{ }\mu\text{A}$ | $-V_{(BR)EBO}$ | > 4.0 | 4.5 V |

¹⁾ Applicable up to $-I_C = 10\text{ mA}$

CHARACTERISTICS (continued)

$T_{amb} = 25\text{ }^{\circ}\text{C}$ unless otherwise specified

| | | 2N2894 | 2N2894A |
|--|------------------|--------------|----------------|
| <u>Sustaining voltage</u> ¹⁾ | | | |
| $I_B = 0; -I_C = 10\text{ mA}$ | $-V_{CEOsust} >$ | 12 | 12 V |
| <u>Saturation voltages</u> ¹⁾ | | | |
| $-I_C = 10\text{ mA}; -I_B = 1.0\text{ mA}$ | $-V_{CEsat} <$ | 0.15 | 0.13 V |
| | $-V_{BEsat}$ | 0.78 to 0.98 | 0.78 to 0.92 V |
| $-I_C = 30\text{ mA}; -I_B = 3.0\text{ mA}$ | $-V_{CEsat} <$ | 0.2 | 0.19 V |
| | $-V_{BEsat}$ | 0.85 to 1.2 | 0.85 to 1.15 V |
| $-I_C = 100\text{ mA}; -I_B = 10\text{ mA}$ | $-V_{CEsat} <$ | 0.5 | 0.45 V |
| | $-V_{BEsat} >$ | - | 1.0 V |
| | $-V_{BEsat} <$ | 1.7 | 1.5 V |
| <u>D.C. current gain</u> ¹⁾ | | | |
| $-I_C = 1.0\text{ mA}; -V_{CE} = 0.5\text{ V}$ | $h_{FE} >$ | - | 20 |
| $-I_C = 10\text{ mA}; -V_{CE} = 0.3\text{ V}$ | $h_{FE} >$ | 30 | 30 |
| $-I_C = 30\text{ mA}; -V_{CE} = 0.5\text{ V}$ | h_{FE} | 40 to 150 | 40 to 120 |
| $-I_C = 30\text{ mA}; -V_{CE} = 0.5\text{ V}; T_{amb} = -55^{\circ}\text{C}$ | $h_{FE} >$ | 17 | 20 |
| $-I_C = 100\text{ mA}; -V_{CE} = 1.0\text{ V}$ | $h_{FE} >$ | 25 | 30 |
| <u>Collector capacitance at $f = 140\text{ kHz}$</u> | | | |
| $I_E = I_e = 0; -V_{CB} = 5.0\text{ V}$ | $C_c <$ | 6.0 | 4.5 pF |
| <u>Emitter capacitance at $f = 140\text{ kHz}$</u> | | | |
| $I_C = I_c = 0; -V_{EB} = 0.5\text{ V}$ | $C_e <$ | 6.0 | 6.0 pF |
| <u>h parameter at $f = 100\text{ MHz}$ (common emitter)</u> | | | |
| $-I_C = 30\text{ mA}; -V_{CE} = 10\text{ V}$ | $h_{fe} >$ | 4.0 | 8.0 |

¹⁾ Pulse duration = 300 μs ; duty cycle = 0.01

2N2894 2N2894A

Switching times

$$-I_C = 30 \text{ mA}; -I_{B1} = +I_{B2} = 1.5 \text{ mA}$$

Turn-on time

Turn-off time

Test circuit:

$$T_{\text{amb}} = 25 \text{ }^\circ\text{C}$$

| | 2N2894 | 2N2894A | |
|------------------|--------|---------|----|
| t_{on} | < 60 | 60 | ns |
| t_{off} | < 90 | 35 | ns |

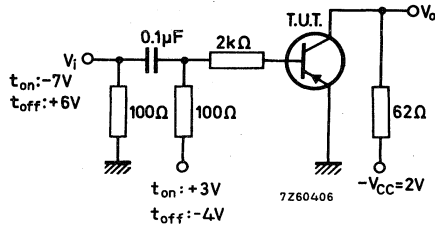

Pulse generator:

| | | | |
|------------------|-------|---|-------------|
| Pulse duration | t_p | > | 200 ns |
| Rise time | t_r | < | 1 ns |
| Output impedance | Z_o | = | 50 Ω |

Sampling scope:

| | | | |
|-----------------|-------|---|----------------|
| Rise time | t_r | < | 1 ns |
| Input impedance | Z_i | = | 100 k Ω |

2N2894 2N2894A

Switching times (continued)

$T_{amb} = 25\text{ }^{\circ}\text{C}$

| | | | | | |
|---------------|---------|-----------|---|----|----|
| Turn-on time | 2N2894A | t_{on} | < | 20 | ns |
| Turn-off time | 2N2894A | t_{off} | < | 25 | ns |
| Storage time | 2N2894A | τ_s | < | 20 | ns |

Test circuit:

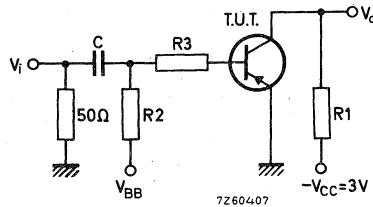

Pulse generator:

| | | | |
|------------------|---|-----|----------|
| Pulse duration | = | 400 | ns |
| Rise time | < | 1 | ns |
| Output impedance | = | 50 | Ω |

Sampling scope:

| | | | |
|-----------------|---|-----|-----------|
| Rise time | < | 1 | ns |
| Input impedance | = | 100 | $k\Omega$ |

| | V_i (V) | V_{BB} (V) | R_1 (Ω) | R_2 ($k\Omega$) | R_3 ($k\Omega$) | $-I_C$ (mA) | $-I_{B1}$ (mA) | I_{B2} (mA) | C (μF) |
|-----------|--------------|-----------------|-----------------------|------------------------|------------------------|----------------|-------------------|------------------|------------------------|
| t_{on} | -6.85 | 0 | 94 | 1.0 | 2.0 | 30 | 3.0 | - | 0.1 |
| t_{off} | 11.7 | -9.85 | 94 | 1.0 | 2.0 | 30 | 3.0 | 3.0 | 0.1 |
| τ_s | 10 | -11 | 270 | 0.5 | 0.5 | 10 | 10 | 10 | 0.33 |

P-N-P MEDIUM POWER GENERAL PURPOSE TRANSISTORS

P-N-P silicon planar epitaxial transistors in a TO-39 metal envelope with the collector connected to the case. These transistors are primarily intended for saturated switching and driver applications for industrial service.

| QUICK REFERENCE DATA | | | |
|--|----------------|------------|--------------------------------|
| Collector-base voltage (open emitter) | $-V_{CBO}$ | max. | 60 V |
| Collector-emitter voltage (open base) | | | |
| | <u>2N2904</u> | $-V_{CEO}$ | max. 40 V |
| | <u>2N2904A</u> | $-V_{CEO}$ | max. 60 V |
| Collector current (d. c.) | $-I_C$ | max. | 0.6 A |
| Total power dissipation up to $T_{amb} = 25^\circ\text{C}$ | P_{tot} | max. | 0.6 W |
| Junction temperature | T_j | max. | 200 $^\circ\text{C}$ |
| Transition frequency | | | |
| $-I_C = 50\text{ mA}; -V_{CE} = 20\text{ V}$ | f_T | > | 200 MHz |
| D. C. current gain at $T_j = 25^\circ\text{C}$ | | | |
| | | | <u>2N2904</u> <u>2N2904A</u> |
| $-I_C = 0.1\text{ mA}; -V_{CE} = 10\text{ V}$ | h_{FE} | > | 20 40 |
| $-I_C = 10\text{ mA}; -V_{CE} = 10\text{ V}$ | h_{FE} | > | 35 40 |
| $-I_C = 500\text{ mA}; -V_{CE} = 10\text{ V}$ | h_{FE} | > | 20 40 |

MECHANICAL DATA

Collector connected
to case
TO-39

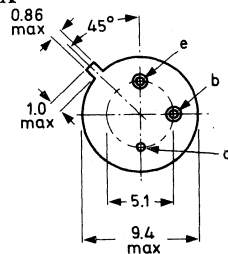

Dimensions in mm

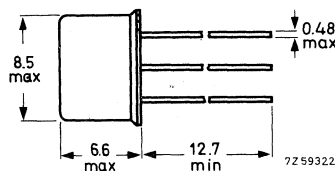

max. lead diameter is guaranteed only for 12.7 mm

Accessories available: 56218, 56245

RATINGS (Limiting values) ¹⁾

Voltages

| | | | |
|---------------------------------------|---------------|------|------|
| Collector-base voltage (open emitter) | $-V_{CBO}$ | max. | 60 V |
| Collector-emitter voltage (open base) | $-V_{CEO}$ | max. | 40 V |
| $-I_C < 100 \text{ mA}$ | <u>2N2904</u> | | |
| | $-V_{CEO}$ | max. | 60 V |
| Emitter-base voltage (open collector) | $-V_{EBO}$ | max. | 5 V |

Current

| | | | |
|--------------------------|--------|------|-------|
| Collector current (d.c.) | $-I_C$ | max. | 0.6 A |
|--------------------------|--------|------|-------|

Power dissipation

| | | | |
|---|-----------|------|-------|
| Total power dissipation up to $T_{amb} = 25 \text{ }^\circ\text{C}$ | P_{tot} | max. | 0.6 W |
| up to $T_{case} = 25 \text{ }^\circ\text{C}$ | P_{tot} | max. | 3 W |

Temperatures

| | | | |
|----------------------|-----------|-------------|------------------|
| Storage temperature | T_{stg} | -65 to +200 | $^\circ\text{C}$ |
| Junction temperature | T_j | max. 200 | $^\circ\text{C}$ |

THERMAL RESISTANCE

| | | | |
|--------------------------------------|----------------------|---|------------------------|
| From junction to ambient in free air | $R_{th \text{ j-a}}$ | = | 290 $^\circ\text{C/W}$ |
| From junction to case | $R_{th \text{ j-c}}$ | = | 58 $^\circ\text{C/W}$ |

¹⁾ Limiting values according to the Absolute Maximum System as defined in IEC publication 134.

CHARACTERISTICS

$T_j = 25\text{ }^\circ\text{C}$ unless otherwise specified

Collector cut-off current

| | 2N2904 | 2N2904A |
|---|-----------------|------------------|
| $I_E = 0; -V_{CB} = 50\text{ V}$ | $-I_{CBO} < 20$ | 10 nA |
| $I_E = 0; -V_{CB} = 50\text{ V}; T_j = 150\text{ }^\circ\text{C}$ | $-I_{CBO} < 20$ | 10 μA |
| $+V_{BE} = 0.5\text{ V}; -V_{CE} = 30\text{ V}$ | $-I_{CEX} <$ | 50 nA |

Breakdown voltages

| | | |
|---|---------------------------------|------|
| $I_E = 0; -I_C = 10\text{ }\mu\text{A}$ | $-V_{(BR)CBO} >$ | 60 V |
| $I_B = 0; -I_C = 10\text{ mA}$ | <u>2N2904</u> $-V_{(BR)CEO} >$ | 40 V |
| | <u>2N2904A</u> $-V_{(BR)CEO} >$ | 60 V |
| $I_C = 0; -I_E = 10\text{ }\mu\text{A}$ | $-V_{(BR)EBO} >$ | 5 V |

Saturation voltages ¹⁾

| | | |
|---|----------------|-------|
| $-I_C = 150\text{ mA}; -I_B = 15\text{ mA}$ | $-V_{CEsat} <$ | 0.4 V |
| | $-V_{BEsat} <$ | 1.3 V |
| $-I_C = 500\text{ mA}; -I_B = 50\text{ mA}$ | $-V_{CEsat} <$ | 1.6 V |
| | $-V_{BEsat} <$ | 2.6 V |

D. C. current gain

| | 2N2904 | 2N2904A |
|--|----------------|---------|
| $-I_C = 0.1\text{ mA}; -V_{CE} = 10\text{ V}$ | $h_{FE} > 20$ | 40 |
| $-I_C = 1\text{ mA}; -V_{CE} = 10\text{ V}$ | $h_{FE} > 25$ | 40 |
| $-I_C = 10\text{ mA}; -V_{CE} = 10\text{ V}$ | $h_{FE} > 35$ | 40 |
| $-I_C = 150\text{ mA}; -V_{CE} = 10\text{ V } ^1)$ | $h_{FE} > 40$ | 40 |
| | $h_{FE} < 120$ | 120 |
| $-I_C = 500\text{ mA}; -V_{CE} = 10\text{ V } ^1)$ | $h_{FE} > 20$ | 40 |

Collector capacitance at $f = 100\text{ kHz}$

| | | |
|--|---------|------|
| $I_E = I_e = 0; -V_{CB} = 10\text{ V}$ | $C_C <$ | 8 pF |
|--|---------|------|

Emitter capacitance at $f = 100\text{ kHz}$

| | | |
|---------------------------------------|---------|-------|
| $I_C = I_c = 0; -V_{EB} = 2\text{ V}$ | $C_e <$ | 30 pF |
|---------------------------------------|---------|-------|

Transition frequency

| | | |
|--|---------|---------|
| $-I_C = 50\text{ mA}; -V_{CE} = 20\text{ V}$ | $f_T >$ | 200 MHz |
|--|---------|---------|

¹⁾ Measured under pulsed conditions to avoid excessive dissipation.
Pulse duration $t \leq 300\text{ }\mu\text{s}$; duty cycle $\delta \leq 0.02$.

2N2904 2N2904A

CHARACTERISTICS (continued)

$T_j = 25\text{ }^\circ\text{C}$

Switching times

Turn on time when switched to $-I_C = 150\text{ mA}$; $-I_B = 15\text{ mA}$

delay time
rise time
turn on time

$t_d < 10\text{ ns}$
 $t_r < 40\text{ ns}$
 $t_{on} < 45\text{ ns}$

Test circuit:

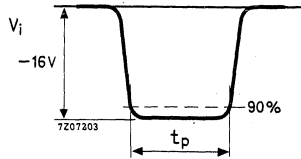
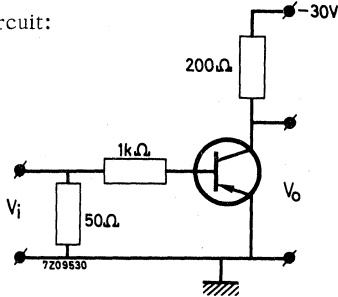

Oscilloscope:

Rise time $t_r \leq 5\text{ ns}$
Input impedance $Z_i = 10\text{ M}\Omega$

Pulse generator: Frequency $f = 150\text{ Hz}$
Pulse duration $t_p = 200\text{ ns}$
Rise time $t_r \leq 2\text{ ns}$
Output impedance $Z_o = 50\text{ }\Omega$

Turn off time when switched from $-I_C = 150\text{ mA}$; $-I_B = 15\text{ mA}$ to cut-off with $+I_{BM} = 15\text{ mA}$

storage time
fall time
turn off time

$t_s < 80\text{ ns}$
 $t_f < 30\text{ ns}$
 $t_{off} < 100\text{ ns}$

Test circuit:

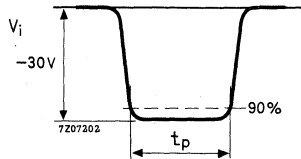
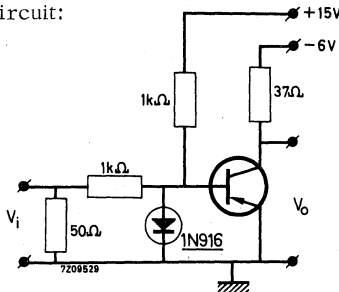

Oscilloscope:

Rise time $t_r \leq 5\text{ ns}$
Input impedance $Z_i = 10\text{ M}\Omega$

Pulse generator: Frequency $f = 150\text{ Hz}$
Pulse duration $t_p = 200\text{ ns}$
Rise time $t_r \leq 2\text{ ns}$
Output impedance $Z_o = 50\text{ }\Omega$

P-N-P MEDIUM POWER GENERAL PURPOSE TRANSISTORS

P-N-P silicon planar epitaxial transistors in a TO-39 metal envelope with the collector connected to the case. These transistors are primarily intended for saturated switching and driver applications for industrial service.

| QUICK REFERENCE DATA | | | |
|--|----------------|------------|--------------------------------|
| Collector-base voltage (open emitter) | $-V_{CBO}$ | max. | 60 V |
| Collector-emitter voltage (open base) | | | |
| | <u>2N2905</u> | $-V_{CEO}$ | max. 40 V |
| | <u>2N2905A</u> | $-V_{CEO}$ | max. 60 V |
| Collector current (d. c.) | $-I_C$ | max. | 0.6 A |
| Total power dissipation up to $T_{amb} = 25^\circ\text{C}$ | P_{tot} | max. | 0.6 W |
| Junction temperature | T_j | max. | 200 $^\circ\text{C}$ |
| Transition frequency | | | |
| $-I_C = 50 \text{ mA}; -V_{CE} = 20 \text{ V}$ | f_T | > | 200 MHz |
| D. C. current gain at $T_j = 25^\circ\text{C}$ | | | <u>2N2905</u> <u>2N2905A</u> |
| $-I_C = 0.1 \text{ mA}; -V_{CE} = 10 \text{ V}$ | h_{FE} | > | 35 75 |
| $-I_C = 10 \text{ mA}; -V_{CE} = 10 \text{ V}$ | h_{FE} | > | 75 100 |
| $-I_C = 500 \text{ mA}; -V_{CE} = 10 \text{ V}$ | h_{FE} | > | 30 50 |

MECHANICAL DATA

Collector connected
to case
TO-39

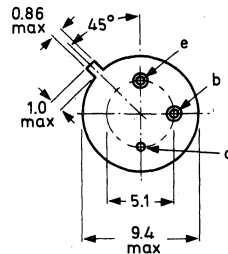

Dimensions in mm

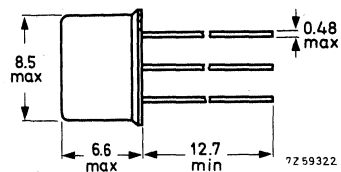

max. lead diameter is guaranteed only for 12.7 mm

Accessories available: 56218, 56245

RATINGS (Limiting values) ¹⁾

Voltages

| | | | |
|---------------------------------------|----------------|------------|-----------|
| Collector-base voltage (open emitter) | $-V_{CBO}$ | max. | 60 V |
| Collector-emitter voltage (open base) | | | |
| $-I_C < 100 \text{ mA}$ | <u>2N2905</u> | $-V_{CEO}$ | max. 40 V |
| | <u>2N2905A</u> | $-V_{CEO}$ | max. 60 V |
| Emitter-base voltage (open collector) | $-V_{EBO}$ | max. | 5 V |

Current

| | | | |
|--------------------------|--------|------|-------|
| Collector current (d.c.) | $-I_C$ | max. | 0.6 A |
|--------------------------|--------|------|-------|

Power dissipation

| | | | |
|---|-----------|------|-------|
| Total power dissipation up to $T_{amb} = 25 \text{ }^\circ\text{C}$ | P_{tot} | max. | 0.6 W |
| up to $T_{case} = 25 \text{ }^\circ\text{C}$ | P_{tot} | max. | 3 W |

Temperatures

| | | | |
|----------------------|-----------|-------------|------------------|
| Storage temperature | T_{stg} | -65 to +200 | $^\circ\text{C}$ |
| Junction temperature | T_j | max. 200 | $^\circ\text{C}$ |

THERMAL RESISTANCE

| | | | |
|--------------------------------------|----------------------|---|------------------------|
| From junction to ambient in free air | $R_{th \text{ j-a}}$ | = | 290 $^\circ\text{C/W}$ |
| From junction to case | $R_{th \text{ j-c}}$ | = | 58 $^\circ\text{C/W}$ |

¹⁾ Limiting values according to the Absolute Maximum System as defined in IEC publication 134.

CHARACTERISTICS

$T_j = 25\text{ }^\circ\text{C}$ unless otherwise specified

Collector cut-off current

| | 2N2905 | 2N2905A |
|---|-----------------|------------------|
| $I_E = 0; -V_{CB} = 50\text{ V}$ | $-I_{CBO} < 20$ | 10 nA |
| $I_E = 0; -V_{CB} = 50\text{ V}; T_j = 150\text{ }^\circ\text{C}$ | $-I_{CBO} < 20$ | 10 μA |
| $+V_{BE} = 0.5\text{ V}; -V_{CE} = 30\text{ V}$ | $-I_{CEX} <$ | 50 nA |

Breakdown voltages

| | 2N2905 | 2N2905A |
|---|------------------|---------|
| $I_E = 0; -I_C = 10\text{ }\mu\text{A}$ | $-V_{(BR)CBO} >$ | 60 V |
| $I_B = 0; -I_C = 10\text{ mA}$ | $-V_{(BR)CEO} >$ | 40 V |
| | $-V_{(BR)CEO} >$ | 60 V |
| $I_C = 0; -I_E = 10\text{ }\mu\text{A}$ | $-V_{(BR)EBO} >$ | 5 V |

Saturation voltages ¹⁾

| | | |
|---|----------------|-------|
| $-I_C = 150\text{ mA}; -I_B = 15\text{ mA}$ | $-V_{CEsat} <$ | 0.4 V |
| | $-V_{BEsat} <$ | 1.3 V |
| $-I_C = 500\text{ mA}; -I_B = 50\text{ mA}$ | $-V_{CEsat} <$ | 1.6 V |
| | $-V_{BEsat} <$ | 2.6 V |

D.C. current gain

| | 2N2905 | 2N2905A |
|---|------------|-----------|
| $-I_C = 0.1\text{ mA}; -V_{CE} = 10\text{ V}$ | $h_{FE} >$ | 35 75 |
| $-I_C = 1\text{ mA}; -V_{CE} = 10\text{ V}$ | $h_{FE} >$ | 50 100 |
| $-I_C = 10\text{ mA}; -V_{CE} = 10\text{ V}$ | $h_{FE} >$ | 75 100 |
| $-I_C = 150\text{ mA}; -V_{CE} = 10\text{ V}$ ¹⁾ | $h_{FE} >$ | 100 100 |
| $-I_C = 500\text{ mA}; -V_{CE} = 10\text{ V}$ ¹⁾ | $h_{FE} <$ | 300 300 |
| | $h_{FE} >$ | 30 50 |

Collector capacitance at $f = 100\text{ kHz}$

| | | |
|--|---------|------|
| $I_E = I_e = 0; -V_{CB} = 10\text{ V}$ | $C_c <$ | 8 pF |
|--|---------|------|

Emitter capacitance at $f = 100\text{ kHz}$

| | | |
|---------------------------------------|---------|-------|
| $I_C = I_c = 0; -V_{EB} = 2\text{ V}$ | $C_e <$ | 30 pF |
|---------------------------------------|---------|-------|

Transition frequency

| | | |
|--|---------|---------|
| $-I_C = 50\text{ mA}; -V_{CE} = 20\text{ V}$ | $f_T >$ | 200 MHz |
|--|---------|---------|

¹⁾ Measured under pulsed conditions to avoid excessive dissipation.
Pulse duration $t \leq 300\text{ }\mu\text{s}$; duty cycle $\delta \leq 0.02$.

2N2905 2N2905A

CHARACTERISTICS (continued)

$T_j = 25\text{ }^\circ\text{C}$

Switching times

Turn on time when switched to $-I_C = 150\text{ mA}$; $-I_B = 15\text{ mA}$

| | |
|--------------|-------------------------|
| delay time | $t_d < 10\text{ ns}$ |
| rise time | $t_r < 40\text{ ns}$ |
| turn on time | $t_{on} < 45\text{ ns}$ |

Test circuit:

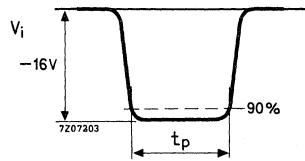
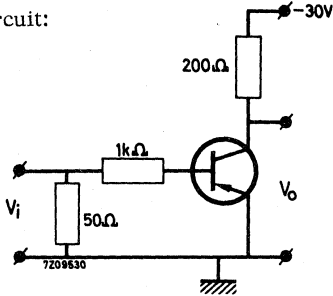

Oscilloscope:

| | |
|-----------------|---------------------------|
| Rise time | $t_r \leq 5\text{ ns}$ |
| Input impedance | $Z_i = 10\text{ M}\Omega$ |

| | |
|----------------------------|--------------------------|
| Pulse generator: Frequency | $f = 150\text{ Hz}$ |
| Pulse duration | $t_p = 200\text{ ns}$ |
| Rise time | $t_r \leq 2\text{ ns}$ |
| Output impedance | $Z_o = 50\text{ }\Omega$ |

Turn off time when switched from $-I_C = 150\text{ mA}$; $-I_B = 15\text{ mA}$ to cut-off with $+I_{BM} = 15\text{ mA}$

| | |
|---------------|---------------------------|
| storage time | $t_s < 80\text{ ns}$ |
| fall time | $t_f < 30\text{ ns}$ |
| turn off time | $t_{off} < 100\text{ ns}$ |

Test circuit:

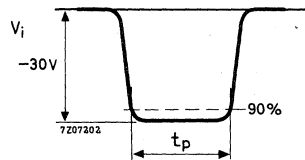
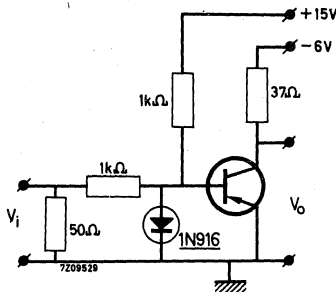

Oscilloscope:

| | |
|-----------------|---------------------------|
| Rise time | $t_r \leq 5\text{ ns}$ |
| Input impedance | $Z_i = 10\text{ M}\Omega$ |

| | |
|----------------------------|--------------------------|
| Pulse generator: Frequency | $f = 150\text{ Hz}$ |
| Pulse duration | $t_p = 200\text{ ns}$ |
| Rise time | $t_r \leq 2\text{ ns}$ |
| Output impedance | $Z_o = 50\text{ }\Omega$ |

**P-N-P MEDIUM POWER
GENERAL PURPOSE TRANSISTORS**

P-N-P silicon planar epitaxial transistors in a TO-18 metal envelope with the collector connected to the case. These transistors are primarily intended for saturated switching and driver applications for industrial service.

| QUICK REFERENCE DATA | | | |
|--|----------------|------------|--------------------------------|
| Collector-base voltage (open emitter) | $-V_{CBO}$ | max. | 60 V |
| Collector-emitter voltage (open base) | | | |
| | <u>2N2906</u> | $-V_{CEO}$ | max. 40 V |
| | <u>2N2906A</u> | $-V_{CEO}$ | max. 60 V |
| Collector current (d.c.) | $-I_C$ | max. | 0.6 A |
| Total power dissipation up to $T_{amb} = 25^\circ\text{C}$ | P_{tot} | max. | 0.4 W |
| Junction temperature | T_j | max. | 200 $^\circ\text{C}$ |
| Transition frequency at $f = 100$ MHz | | | |
| $-I_C = 50$ mA; $-V_{CE} = 20$ V; $T_{amb} = 25^\circ\text{C}$ | f_T | > | 200 MHz |
| D.C. current gain at $T_j = 25^\circ\text{C}$ | | | |
| | | | <u>2N2906</u> <u>2N2906A</u> |
| $-I_C = 0.1$ mA; $-V_{CE} = 10$ V | h_{FE} | > 20 | 40 |
| $-I_C = 10$ mA; $-V_{CE} = 10$ V | h_{FE} | > 35 | 40 |
| $-I_C = 500$ mA; $-V_{CE} = 10$ V | h_{FE} | > 20 | 40 |

MECHANICAL DATA

Dimensions in mm

Collector connected to case

TO-18

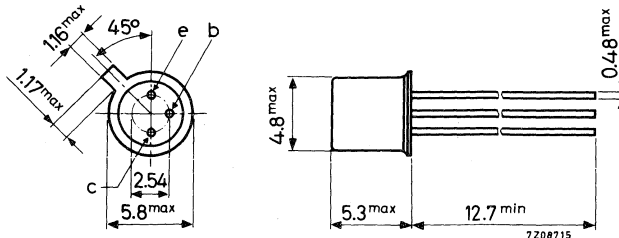

Accessories available: 56246, 56263

2N2906 2N2906A

RATINGS Limiting values in accordance with the Absolute Maximum System (IEC 134)

Voltages

| | | | |
|---------------------------------------|----------------|------------|-----------|
| Collector-base voltage (open emitter) | $-V_{CBO}$ | max. | 60 V |
| Collector-emitter voltage (open base) | | | |
| $-I_C < 100 \text{ mA}$ | <u>2N2906</u> | $-V_{CEO}$ | max. 40 V |
| | <u>2N2906A</u> | $-V_{CEO}$ | max. 60 V |
| Emitter-base voltage (open collector) | $-V_{EBO}$ | max. | 5 V |

Current

| | | | |
|--------------------------|--------|------|-------|
| Collector current (d.c.) | $-I_C$ | max. | 0.6 A |
|--------------------------|--------|------|-------|

Power dissipation

| | | | |
|---|-----------|------|-------|
| Total power dissipation up to $T_{amb} = 25 \text{ }^\circ\text{C}$ | P_{tot} | max. | 0.4 W |
| up to $T_{case} = 25 \text{ }^\circ\text{C}$ | P_{tot} | max. | 1.8 W |

Temperatures

| | | | |
|----------------------|-----------|-------------|------------------|
| Storage temperature | T_{stg} | -65 to +200 | $^\circ\text{C}$ |
| Junction temperature | T_j | max. 200 | $^\circ\text{C}$ |

THERMAL RESISTANCE

| | | | |
|--------------------------------------|----------------------|---|------------------------|
| From junction to ambient in free air | $R_{th \text{ j-a}}$ | = | 438 $^\circ\text{C/W}$ |
| From junction to case | $R_{th \text{ j-c}}$ | = | 97 $^\circ\text{C/W}$ |

CHARACTERISTICS

$T_j = 25\text{ }^\circ\text{C}$ unless otherwise specified

Collector cut-off current

| | 2N2906 | 2N2906A |
|---|-----------------|------------------|
| $I_E = 0; -V_{CB} = 50\text{ V}$ | $-I_{CBO} < 20$ | 10 nA |
| $I_E = 0; -V_{CB} = 50\text{ V}; T_j = 150\text{ }^\circ\text{C}$ | $-I_{CBO} < 20$ | 10 μA |
| $+V_{BE} = 0.5\text{ V}; -V_{CE} = 30\text{ V}$ | $-I_{CEX} <$ | 50 nA |

Breakdown voltages

| | 2N2906 | 2N2906A |
|---|------------------|---------|
| $I_E = 0; -I_C = 10\text{ }\mu\text{A}$ | $-V_{(BR)CBO} >$ | 60 V |
| $I_B = 0; -I_C = 10\text{ mA}$ | $-V_{(BR)CEO} >$ | 40 V |
| | $-V_{(BR)CEO} >$ | 60 V |
| $I_C = 0; -I_E = 10\text{ }\mu\text{A}$ | $-V_{(BR)EBO} >$ | 5 V |

Saturation voltages ¹⁾

| | | |
|---|----------------|-------|
| $-I_C = 150\text{ mA}; -I_B = 15\text{ mA}$ | $-V_{CEsat} <$ | 0.4 V |
| | $-V_{BEsat} <$ | 1.3 V |
| $-I_C = 500\text{ mA}; -I_B = 50\text{ mA}$ | $-V_{CEsat} <$ | 1.6 V |
| | $-V_{BEsat} <$ | 2.6 V |

D.C. current gain

| | 2N2906 | 2N2906A |
|---|----------------|---------|
| $-I_C = 0.1\text{ mA}; -V_{CE} = 10\text{ V}$ | $h_{FE} > 20$ | 40 |
| $-I_C = 1\text{ mA}; -V_{CE} = 10\text{ V}$ | $h_{FE} > 25$ | 40 |
| $-I_C = 10\text{ mA}; -V_{CE} = 10\text{ V}$ | $h_{FE} > 35$ | 40 |
| $-I_C = 150\text{ mA}; -V_{CE} = 10\text{ V}$ ¹⁾ | $h_{FE} > 40$ | 40 |
| $-I_C = 500\text{ mA}; -V_{CE} = 10\text{ V}$ ¹⁾ | $h_{FE} < 120$ | 120 |
| | $h_{FE} > 20$ | 40 |

Collector capacitance at $f = 100\text{ kHz}$

| | | |
|--|---------|------|
| $I_E = I_e = 0; -V_{CB} = 10\text{ V}$ | $C_c <$ | 8 pF |
|--|---------|------|

Emitter capacitance at $f = 100\text{ kHz}$

| | | |
|---------------------------------------|---------|-------|
| $I_C = I_c = 0; -V_{EB} = 2\text{ V}$ | $C_e <$ | 30 pF |
|---------------------------------------|---------|-------|

Transition frequency at $f = 100\text{ MHz}$

| | | |
|--|---------|---------|
| $-I_C = 50\text{ mA}; -V_{CE} = 20\text{ V}; T_{amb} = 25\text{ }^\circ\text{C}$ | $f_T >$ | 200 MHz |
|--|---------|---------|

¹⁾ Measured under pulsed conditions to avoid excessive dissipation.
Pulse duration $t \leq 300\text{ }\mu\text{s}$; duty cycle $\delta \leq 0.02$.

2N2906 2N2906A

CHARACTERISTICS (continued)

$T_j = 25\text{ }^\circ\text{C}$

Switching times

Turn on time when switched to $-I_C = 150\text{ mA}$; $-I_B = 15\text{ mA}$

delay time
rise time
turn on time

$t_d < 10\text{ ns}$
 $t_r < 40\text{ ns}$
 $t_{on} < 45\text{ ns}$

Test circuit:

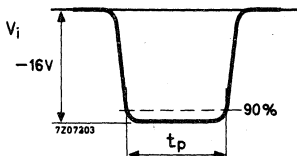
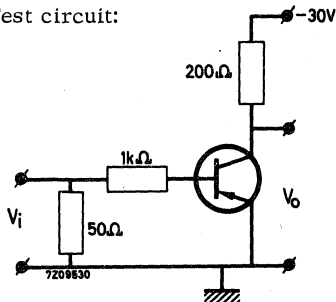

Oscilloscope:

Rise time $t_r \leq 5\text{ ns}$
Input impedance $Z_i = 10\text{ M}\Omega$

Pulse generator: Frequency $f = 150\text{ Hz}$
Pulse duration $t_p = 200\text{ ns}$
Rise time $t_r \leq 2\text{ ns}$
Output impedance $Z_o = 50\text{ }\Omega$

Turn off time when switched from

$-I_C = 150\text{ mA}$; $-I_B = 15\text{ mA}$ to cut-off with $+I_{BM} = 15\text{ mA}$

storage time
fall time
turn off time

$t_s < 80\text{ ns}$
 $t_f < 30\text{ ns}$
 $t_{off} < 100\text{ ns}$

Test circuit:

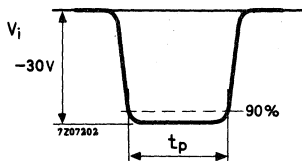
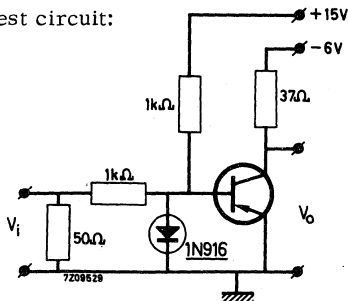

Oscilloscope:

Rise time $t_r \leq 5\text{ ns}$
Input impedance $Z_i = 10\text{ M}\Omega$

Pulse generator: Frequency $f = 150\text{ Hz}$
Pulse duration $t_p = 200\text{ ns}$
Rise time $t_r \leq 2\text{ ns}$
Output impedance $Z_o = 50\text{ }\Omega$

P-N-P MEDIUM POWER GENERAL PURPOSE TRANSISTORS

P-N-P silicon planar epitaxial transistors in a TO-18 metal envelope with the collector connected to the case. These transistors are primarily intended for saturated switching and driver applications for industrial service.

| QUICK REFERENCE DATA | | | |
|--|----------------|------------|--------------------------------|
| Collector-base voltage (open emitter) | $-V_{CBO}$ | max. | 60 V |
| Collector-emitter voltage (open base) | | | |
| | <u>2N2907</u> | $-V_{CEO}$ | max. 40 V |
| | <u>2N2907A</u> | $-V_{CEO}$ | max. 60 V |
| Collector current (d.c.) | $-I_C$ | max. | 0.6 A |
| Total power dissipation up to $T_{amb} = 25\text{ }^\circ\text{C}$ | P_{tot} | max. | 0.4 W |
| Junction temperature | $-T_j$ | max. | 200 $^\circ\text{C}$ |
| Transition frequency at $f = 100\text{ MHz}$ | | | |
| $-I_C = 50\text{ mA}; -V_{CE} = 20\text{ V}; T_{amb} = 25\text{ }^\circ\text{C}$ | f_T | > | 200 MHz |
| D.C. current gain at $T_j = 25\text{ }^\circ\text{C}$ | | | |
| | | | <u>2N2907</u> <u>2N2907A</u> |
| $-I_C = 0.1\text{ mA}; -V_{CE} = 10\text{ V}$ | h_{FE} | > 35 | 75 |
| $-I_C = 10\text{ mA}; -V_{CE} = 10\text{ V}$ | h_{FE} | > 75 | 100 |
| $-I_C = 500\text{ mA}; -V_{CE} = 10\text{ V}$ | h_{FE} | > 30 | 50 |

MECHANICAL DATA

Dimensions in mm

Collector connected to case
TO-18

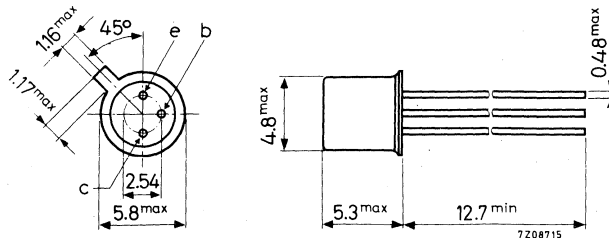

Accessories available: 56246, 56263

RATINGS Limiting values in accordance with the Absolute Maximum System (IEC134).

Voltages

| | | | |
|---------------------------------------|------------|------|------|
| Collector-base voltage (open emitter) | $-V_{CBO}$ | max. | 60 V |
| Collector-emitter voltage (open base) | | | |
| $-I_C < 100 \text{ mA}$ | $-V_{CEO}$ | max. | 40 V |
| | $-V_{CEO}$ | max. | 60 V |
| Emitter-base voltage (open collector) | $-V_{EBO}$ | max. | 5 V |

Current

| | | | |
|--------------------------|--------|------|-------|
| Collector current (d.c.) | $-I_C$ | max. | 0.6 A |
|--------------------------|--------|------|-------|

Power dissipation

| | | | |
|---|-----------|------|-------|
| Total power dissipation up to $T_{amb} = 25 \text{ }^\circ\text{C}$ | P_{tot} | max. | 0.4 W |
| up to $T_{case} = 25 \text{ }^\circ\text{C}$ | P_{tot} | max. | 1.8 W |

Temperatures

| | | | |
|----------------------|-----------|-------------|----------------------|
| Storage temperature | T_{stg} | -65 to +200 | $^\circ\text{C}$ |
| Junction temperature | T_j | max. | 200 $^\circ\text{C}$ |

THERMAL RESISTANCE

| | | | |
|--------------------------------------|----------------------|---|------------------------|
| From junction to ambient in free air | $R_{th \text{ j-a}}$ | = | 438 $^\circ\text{C/W}$ |
| From junction to case | $R_{th \text{ j-c}}$ | = | 97 $^\circ\text{C/W}$ |



CHARACTERISTICS

$T_j = 25\text{ }^\circ\text{C}$ unless otherwise specified

Collector cut-off current

| | 2N2907 | 2N2907A |
|---|-----------------|------------------|
| $I_E = 0; -V_{CB} = 50\text{ V}$ | $-I_{CBO} < 20$ | 10 nA |
| $I_E = 0; -V_{CB} = 50\text{ V}; T_j = 150\text{ }^\circ\text{C}$ | $-I_{CBO} < 20$ | 10 μA |
| $+V_{BE} = 0.5\text{ V}; -V_{CE} = 30\text{ V}$ | $-I_{CEX} <$ | 50 nA |

Breakdown voltages

| | 2N2907 | 2N2907A |
|---|------------------|---------|
| $I_E = 0; -I_C = 10\text{ }\mu\text{A}$ | $-V_{(BR)CBO} >$ | 60 V |
| $I_B = 0; -I_C = 10\text{ mA}$ | $-V_{(BR)CEO} >$ | 40 V |
| | $-V_{(BR)CEO} >$ | 60 V |
| $I_C = 0; -I_E = 10\text{ }\mu\text{A}$ | $-V_{(BR)EBO} >$ | 5 V |

Saturation voltages ¹⁾

| | | |
|---|----------------|-------|
| $-I_C = 150\text{ mA}; -I_B = 15\text{ mA}$ | $-V_{CEsat} <$ | 0.4 V |
| | $-V_{BEsat} <$ | 1.3 V |
| $-I_C = 500\text{ mA}; -I_B = 50\text{ mA}$ | $-V_{CEsat} <$ | 1.6 V |
| | $-V_{BEsat} <$ | 2.6 V |

D.C. current gain

| | 2N2907 | 2N2907A |
|--|------------|-----------|
| $-I_C = 0.1\text{ mA}; -V_{CE} = 10\text{ V}$ | $h_{FE} >$ | 35 75 |
| $-I_C = 1\text{ mA}; -V_{CE} = 10\text{ V}$ | $h_{FE} >$ | 50 100 |
| $-I_C = 10\text{ mA}; -V_{CE} = 10\text{ V}$ | $h_{FE} >$ | 75 100 |
| $-I_C = 150\text{ mA}; -V_{CE} = 10\text{ V}^1)$ | $h_{FE} >$ | 100 100 |
| $-I_C = 500\text{ mA}; -V_{CE} = 10\text{ V}^1)$ | $h_{FE} >$ | 300 300 |
| | $h_{FE} >$ | 30 50 |

Collector capacitance at $f = 100\text{ kHz}$

| | | |
|--|---------|------|
| $I_E = I_e = 0; -V_{CB} = 10\text{ V}$ | $C_c <$ | 8 pF |
|--|---------|------|

Emitter capacitance at $f = 100\text{ kHz}$

| | | |
|---------------------------------------|---------|-------|
| $I_C = I_c = 0; -V_{EB} = 2\text{ V}$ | $C_e <$ | 30 pF |
|---------------------------------------|---------|-------|

Transition frequency at $f = 100\text{ MHz}$

| | | |
|--|---------|---------|
| $-I_C = 50\text{ mA}; -V_{CE} = 20\text{ V}; T_{amb} = 25\text{ }^\circ\text{C}$ | $f_T >$ | 200 MHz |
|--|---------|---------|

¹⁾ Measured under pulsed conditions to avoid excessive dissipation.
Pulsed duration $t \leq 300\text{ }\mu\text{s}$; duty cycle $\delta \leq 0.02$.

2N2907 2N2907A

CHARACTERISTICS (continued)

$T_j = 25\text{ }^\circ\text{C}$

Switching times

Turn on time when switched to $-I_C = 150\text{ mA}$; $-I_B = 15\text{ mA}$

delay time
rise time
turn on time

$t_d < 10\text{ ns}$
 $t_r < 40\text{ ns}$
 $t_{on} < 45\text{ ns}$

Test circuit:

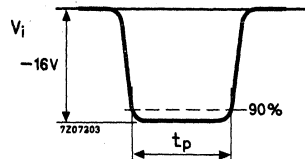
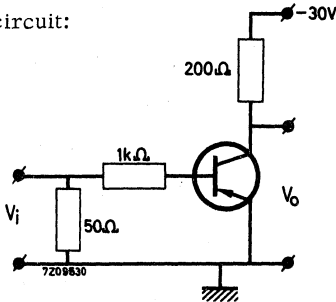

Oscilloscope:

Rise time $t_r \leq 5\text{ ns}$
Input impedance $Z_i = 10\text{ M}\Omega$

Pulse generator: Frequency $f = 150\text{ Hz}$
Pulse duration $t_p = 200\text{ ns}$
Rise time $t_r \leq 2\text{ ns}$
Output impedance $Z_o = 50\text{ }\Omega$

Turn off time when switched from
 $-I_C = 150\text{ mA}$; $-I_B = 15\text{ mA}$ to cut-off with $+I_{BM} = 15\text{ mA}$

storage time
fall time
turn off time

$t_s < 80\text{ ns}$
 $t_f < 30\text{ ns}$
 $t_{off} < 100\text{ ns}$

Test circuit:

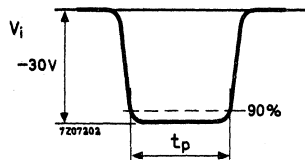
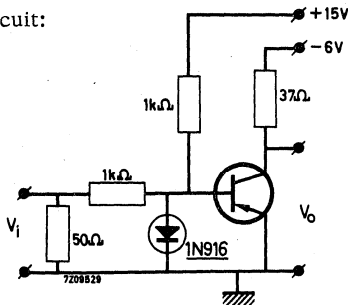

Oscilloscope:

Rise time $t_r \leq 5\text{ ns}$
Input impedance $Z_i = 10\text{ M}\Omega$

Pulse generator: Frequency $f = 150\text{ Hz}$
Pulse duration $t_p = 200\text{ ns}$
Rise time $t_r \leq 2\text{ ns}$
Output impedance $Z_o = 50\text{ }\Omega$

SILICON PLANAR EPITAXIAL TRANSISTORS

N-P-N transistors in TO-39 metal envelopes intended for use as amplifiers and in switching circuits.

| QUICK REFERENCE DATA | | | | | |
|---|-----------|------|--------|------------------|-----|
| Collector-base voltage (open emitter) | V_{CBO} | max. | 140 | V | |
| Collector-emitter voltage (open base) | V_{CEO} | max. | 80 | V | |
| Collector current (d. c.) | I_C | max. | 1 | A | |
| Total power dissipation up to $T_{amb} = 25\text{ }^\circ\text{C}$ up to $T_{case} = 25\text{ }^\circ\text{C}$ | P_{tot} | max. | 0,8 | W | |
| | P_{tot} | max. | 5,0 | W | |
| Junction temperature | T_j | max. | 200 | $^\circ\text{C}$ | |
| D. C. current gain $I_C = 150\text{ mA}; V_{CE} = 10\text{ V}$ | h_{FE} | | 2N3019 | 2N3020 | |
| | | > | 100 | 40 | |
| | | < | 300 | 120 | |
| Transition frequency at $f = 20\text{ MHz}$ $I_C = 50\text{ mA}; V_{CE} = 10\text{ V}$ | f_T | > | 100 | 80 | MHz |

MECHANICAL DATA

Dimensions in mm

Collector connected to case

TO-39

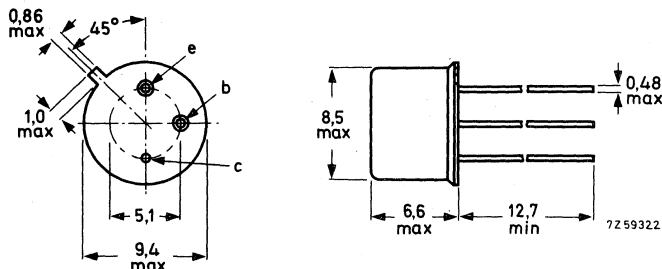

max. lead diameter is guaranteed only for 12,7 mm

Accessories : 56218 (package); 56245 (distance disc).

RATINGS Limiting values in accordance with the Absolute Maximum System (IEC 134)

Voltages

| | | | | |
|---------------------------------------|-----------|------|-----|---|
| Collector-base voltage (open emitter) | V_{CBO} | max. | 140 | V |
| Collector-emitter voltage (open base) | V_{CEO} | max. | 80 | V |
| Emitter-base voltage (open collector) | V_{EBO} | max. | 7 | V |

Current

| | | | | |
|---------------------------|-------|------|---|---|
| Collector current (d. c.) | I_C | max. | 1 | A |
|---------------------------|-------|------|---|---|

Power dissipation

| | | | | |
|--|-----------|------|-----|---|
| Total power dissipation up to $T_{amb} = 25\text{ }^\circ\text{C}$ | P_{tot} | max. | 0,8 | W |
| up to $T_{case} = 25\text{ }^\circ\text{C}$ | P_{tot} | max. | 5,0 | W |

Temperatures

| | | | |
|----------------------|-----------|-------------|----------------------|
| Storage temperature | T_{stg} | -65 to +200 | $^\circ\text{C}$ |
| Junction temperature | T_j | max. | 200 $^\circ\text{C}$ |

THERMAL RESISTANCE

| | | | | |
|--------------------------------------|---------------|---|-----|--------------------|
| From junction to ambient in free air | $R_{th\ j-a}$ | = | 218 | $^\circ\text{C/W}$ |
| From junction to case | $R_{th\ j-c}$ | = | 35 | $^\circ\text{C/W}$ |

CHARACTERISTICS

$T_{amb} = 25\text{ }^\circ\text{C}$ unless otherwise specified

Collector cut-off current

| | | | | |
|--|-----------|---|----|---------------|
| $I_E = 0; V_{CB} = 90\text{ V}$ | I_{CBO} | < | 10 | nA |
| $I_E = 0; V_{CB} = 90\text{ V}; T_{amb} = 150\text{ }^\circ\text{C}$ | I_{CBO} | < | 10 | μA |

Emitter cut-off current

| | | | | |
|--------------------------------|-----------|---|----|----|
| $I_C = 0; V_{EB} = 5\text{ V}$ | I_{EBO} | < | 10 | nA |
|--------------------------------|-----------|---|----|----|

Breakdown voltages

| | | | | |
|---|---------------|---|-----|------|
| $I_E = 0; I_C = 100\text{ }\mu\text{A}$ | $V_{(BR)CBO}$ | > | 140 | V |
| $I_B = 0; I_C = 30\text{ mA}$ | $V_{(BR)CEO}$ | > | 80 | V 1) |
| $I_C = 0; I_E = 100\text{ }\mu\text{A}$ | $V_{(BR)EBO}$ | > | 7 | V |

Saturation voltages

| | | | | |
|---|-------------|---|-----|------|
| $I_C = 150\text{ mA}; I_B = 15\text{ mA}$ | V_{CEsat} | < | 0,2 | V |
| | V_{BEsat} | < | 1,1 | V 1) |
| $I_C = 500\text{ mA}; I_B = 50\text{ mA}$ | V_{CEsat} | < | 0,5 | V 1) |

1) Measured under pulse conditions: $t_p = 300\text{ }\mu\text{s}; \delta \leq 0,01$.

CHARACTERISTICS (continued)

$T_{amb} = 25\text{ }^{\circ}\text{C}$ unless otherwise specified

| | | 2N3019 | 2N3020 | |
|---|------------------|--------|--------|-----|
| <u>D.C. current gain</u> ¹⁾ | | | | |
| $I_C = 0,1\text{ mA}; V_{CE} = 10\text{ V}$ | h_{FE} | > 50 | 30 | |
| | | < - | 100 | |
| $I_C = 10\text{ mA}; V_{CE} = 10\text{ V}$ | h_{FE} | > 90 | 40 | |
| | | < - | 120 | |
| $I_C = 150\text{ mA}; V_{CE} = 10\text{ V}$ | h_{FE} | > 100 | 40 | |
| | | < 300 | 120 | |
| $I_C = 150\text{ mA}; V_{CE} = 10\text{ V}; T_{case} = -55\text{ }^{\circ}\text{C}$ | h_{FE} | > 40 | - | |
| | | < - | - | |
| $I_C = 500\text{ mA}; V_{CE} = 10\text{ V}$ | h_{FE} | > 50 | 30 | |
| | | < - | 100 | |
| $I_C = 1000\text{ mA}; V_{CE} = 10\text{ V}$ | h_{FE} | > 15 | 15 | |
| | | < - | - | |
| <u>Transition frequency at $f = 20\text{ MHz}$</u> | | | | |
| $I_C = 50\text{ mA}; V_{CE} = 10\text{ V}$ | f_T | > 100 | 80 | MHz |
| <u>Collector capacitance at $f = 1\text{ MHz}$</u> | | | | |
| $I_E = I_e = 0; V_{CB} = 10\text{ V}$ | C_c | < 12 | 12 | pF |
| <u>Emitter capacitance at $f = 1\text{ MHz}$</u> | | | | |
| $I_C = I_c = 0; V_{EB} = 0,5\text{ V}$ | C_e | < 60 | 60 | pF |
| <u>Feedback time constant at $f = 4\text{ MHz}$</u> | | | | |
| $I_C = 10\text{ mA}; V_{CB} = 10\text{ V}$ | $r_{bb}'C_{b'c}$ | < 400 | 400 | ps |
| <u>Small-signal current gain at $f = 1\text{ kHz}$</u> | | | | |
| $I_C = 1,0\text{ mA}; V_{CE} = 5\text{ V}$ | h_{fe} | > 80 | 30 | |
| | | < 400 | 200 | |
| <u>Noise figure at $f = 1\text{ kHz}$</u> | | | | |
| $I_C = 0,1\text{ mA}; V_{CE} = 10\text{ V}; R_S = 1\text{ k}\Omega$ | F | < 4 | - | dB |

¹⁾ Measured under pulse conditions: $t_p = 300\text{ }\mu\text{s}; \delta \leq 0,01$.

SILICON EPITAXIAL TRANSISTOR

P-N-P transistor in a TO-39 metal envelope with the collector connected to the case. The transistor is intended for general industrial applications.

| QUICK REFERENCE DATA | | | |
|---|--------------|------|----------------------|
| Collector-base voltage (open emitter) | $-V_{CBO}$ | max. | 90 V |
| Collector-emitter voltage (open base) | $-V_{CEO}$ | max. | 65 V |
| Collector current (d. c.) | $-I_C$ | max. | 1.0 A |
| Total power dissipation up to $T_{case} = 25\text{ }^\circ\text{C}$ | P_{tot} | max. | 5 W |
| Junction temperature | T_j | max. | 200 $^\circ\text{C}$ |
| Collector-emitter saturation voltage $-I_C = 150\text{ mA}; -I_B = 15\text{ mA}$ | $-V_{CEsat}$ | < | 0.65 V |
| D. C. current gain $-I_C = 150\text{ mA}; -V_{CE} = 10\text{ V}$ | h_{FE} | | 40 to 140 |
| Transition frequency at $f = 20\text{ MHz}$ $-I_C = 50\text{ mA}; -V_{CE} = 10\text{ V}$ | f_T | > | 60 MHz |

MECHANICAL DATA

Dimensions in mm

TO-39
Collector connected
to case

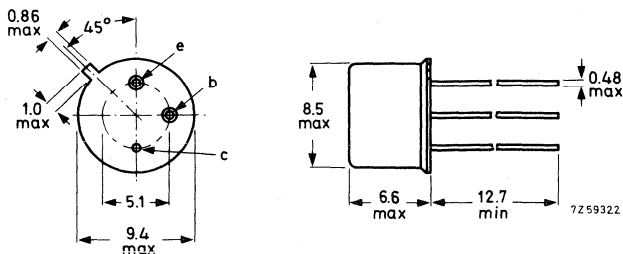

max. lead diameter is guaranteed only for 12.7 mm.

Accessories supplied on request: 56218, 56245

RATINGS Limiting values in accordance with the Absolute Maximum System (IEC 134)

Voltages

| | | | | |
|---------------------------------------|------------|------|----|---|
| Collector-base voltage (open emitter) | $-V_{CBO}$ | max. | 90 | V |
| Collector-emitter voltage (open base) | $-V_{CEO}$ | max. | 65 | V |
| Emitter-base voltage (open collector) | $-V_{EBO}$ | max. | 7 | V |

Currents

| | | | | |
|---------------------------|--------|------|-----|---|
| Collector current (d. c.) | $-I_C$ | max. | 1.0 | A |
| Base current (d. c.) | $-I_B$ | max. | 0.5 | A |

Power dissipation

| | | | | |
|---|-----------|------|---|---|
| Total power dissipation up to $T_{case} = 25\text{ }^{\circ}\text{C}$ | P_{tot} | max. | 5 | W |
|---|-----------|------|---|---|

Temperatures

| | | | |
|----------------------|-----------|-------------|--------------------|
| Storage temperature | T_{stg} | -65 to +200 | $^{\circ}\text{C}$ |
| Junction temperature | T_j | max. 200 | $^{\circ}\text{C}$ |

THERMAL RESISTANCE

| | | | | |
|-----------------------|---------------|---|----|-----------------------------|
| From junction to case | $R_{th\ j-c}$ | = | 35 | $^{\circ}\text{C}/\text{W}$ |
|-----------------------|---------------|---|----|-----------------------------|

CHARACTERISTICS

$T_j = 25^\circ\text{C}$ unless otherwise specified.

Collector cut-off current

| | | | | |
|---|------------|---|-----|---------------|
| $I_E = 0; -V_{CB} = 60\text{ V}$ | $-I_{CBO}$ | < | 20 | nA |
| $+V_{BE} = 1.5\text{ V}; V_{CE} = 30\text{ V}; T_{\text{case}} = 150^\circ\text{C}$ | $-I_{CEX}$ | < | 100 | μA |

Breakdown voltages

Collector-base voltage

| | | | | |
|------------------------------------|----------------|---|----|---|
| $I_E = 0; -I_C = 100\ \mu\text{A}$ | $-V_{(BR)CBO}$ | > | 90 | V |
|------------------------------------|----------------|---|----|---|

Collector-emitter voltage

| | | | | |
|--|----------------|---|----|---|
| $+V_{BE} = 1.5\text{ V}; -I_C = 100\text{ mA}$ | $-V_{(BR)CEX}$ | > | 85 | V |
|--|----------------|---|----|---|

Emitter-base voltage

| | | | | |
|-----------------------------------|----------------|---|---|---|
| $I_C = 0; I_E = 100\ \mu\text{A}$ | $-V_{(BR)EBO}$ | > | 7 | V |
|-----------------------------------|----------------|---|---|---|

Collector-emitter sustaining voltage

| | | | | |
|---------------------------------|----------------|---|----|---|
| $I_B = 0; -I_C = 100\text{ mA}$ | $-V_{CEOsust}$ | > | 65 | V |
|---------------------------------|----------------|---|----|---|

Saturation voltage

| | | | | |
|---|--------------|---|------|---|
| $-I_C = 150\text{ mA}; -I_B = 15\text{ mA}$ | $-V_{CEsat}$ | < | 0.65 | V |
| | $-V_{BEsat}$ | < | 1.4 | V |

D. C. current gain

| | | | |
|---|----------|---|-----------|
| $-I_C = 0.1\text{ mA}; -V_{CE} = 10\text{ V}$ | h_{FE} | > | 20 |
| $-I_C = 150\text{ mA}; -V_{CE} = 10\text{ V}$ | h_{FE} | | 40 to 140 |
| $-I_C = 150\text{ mA}; -V_{CE} = 2\text{ V}$ | h_{FE} | | 20 to 200 |
| $-I_C = 500\text{ mA}; -V_{CE} = 10\text{ V}$ | h_{FE} | > | 20 |

Transition frequency at $f = 20\text{ MHz}$

| | | | | |
|--|-------|---|----|-----|
| $-I_C = 50\text{ mA}; -V_{CE} = 10\text{ V}$ | f_T | > | 60 | MHz |
|--|-------|---|----|-----|

Collector-base capacitance at $f = 1\text{ MHz}$

| | | | | |
|--|-------|---|----|----|
| $I_E = I_e = 0; -V_{CB} = 10\text{ V}$ | C_c | < | 30 | pF |
|--|-------|---|----|----|

2N4036

Switching times

Turn on time

$$-I_C = 150 \text{ mA}; -I_B = +I_{BM} = 15 \text{ mA}$$

rise time

turn on time

| | | | |
|----------|---|-----|----|
| t_r | < | 70 | ns |
| t_{on} | < | 110 | ns |

Turn off time

$$-I_C = 150 \text{ mA}; -I_B = +I_{BM} = 15 \text{ mA}$$

storage time

fall time

turn off time

| | | | |
|-----------|---|-----|----|
| t_s | < | 600 | ns |
| t_f | < | 100 | ns |
| t_{off} | < | 700 | ns |

Test circuit:

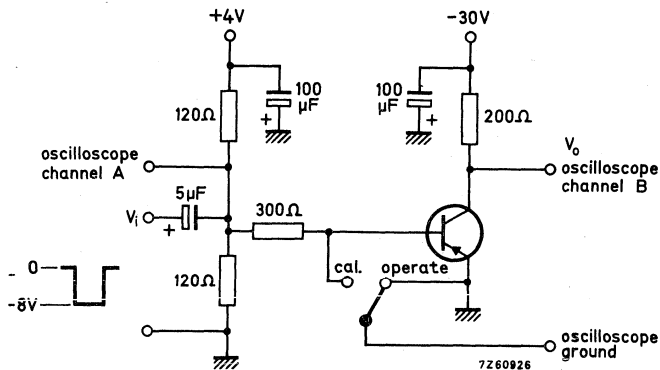

Pulse generator:

$f = 10 \text{ kHz}$
 $t_r < 10 \text{ ns}$
 $t_p = 20 \mu\text{s}$

Oscilloscope:

$Z_i = 10 \text{ M}\Omega$
 $C_i = 20 \text{ pF}$
 $t_r < 15 \text{ ns}$

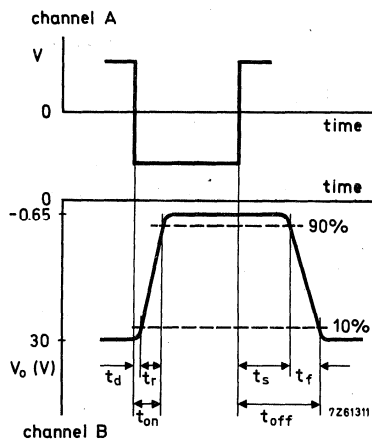

Accessories



Introduction

All information on thermal resistances of the accessories combined with flat heat-sinks is valid for square heatsinks of 1.5 mm blackened aluminium.

For a few variations the thermal resistance may be derived as follows:

a. Rectangular heatsinks (sides a and 2a)

When mounted with long side horizontal, multiply by 0.95.

When mounted with short side horizontal, multiply by 1.10.

b. Unblackened or thinner heatsinks

Multiply by the factor B given below as a function of the heatsink size A.

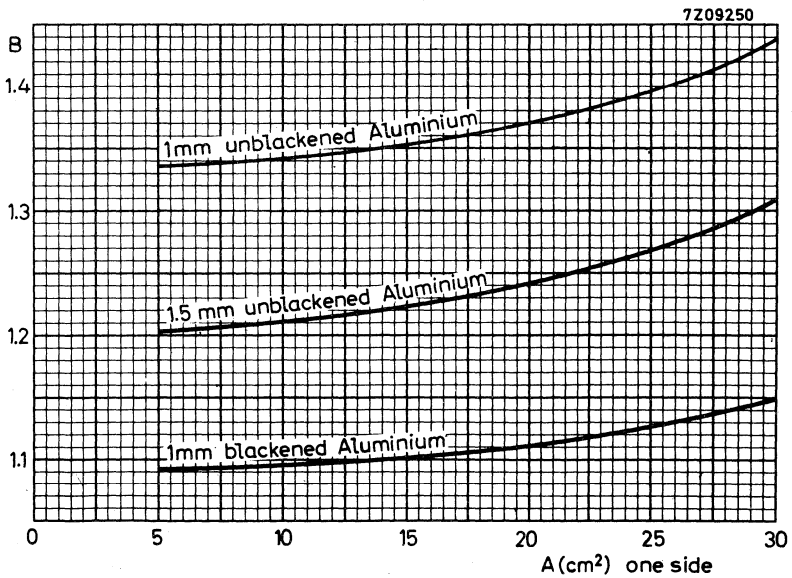

COOLING FIN

MECHANICAL DATA

Dimensions in mm

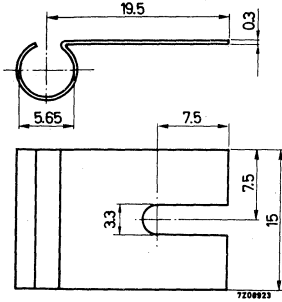

Fin material: brass, nickel plated

THERMAL RESISTANCE

From case to ambient with cooling fin only
with heatsink

$$R_{th\ c-a} = 100\ ^\circ C/W$$

see graph

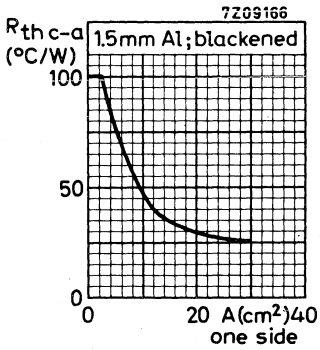

MOUNTING INSTRUCTIONS

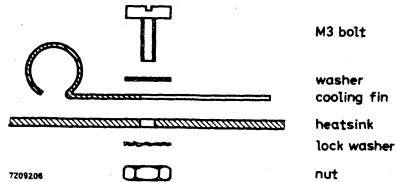

Torque on nut for good heat transfer: 5 cm kg

MOUNTING ACCESSORIES

Mounting accessories for TO-5 envelopes. The package consists of:

- 1 top clamping piece
- 1 bottom clamping piece
- 1 mylar insulator

MECHANICAL DATA

Dimensions in mm

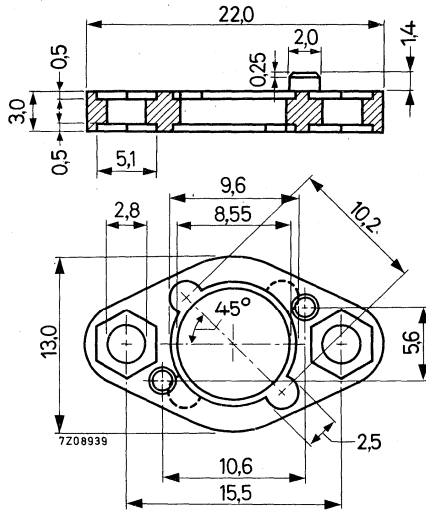

top clamping piece
of insulating material

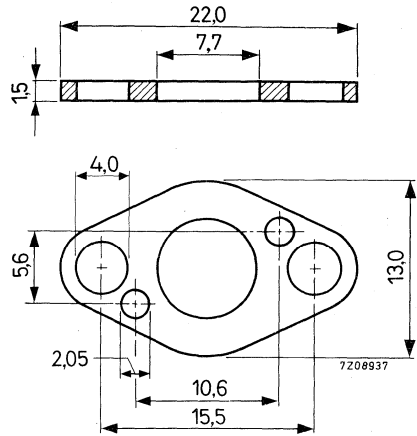

bottom clamping piece
material: brass, tin-plated

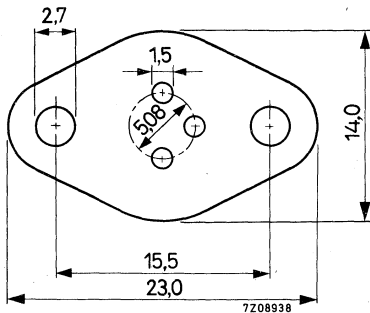
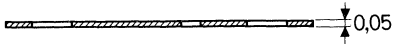

mylar insulator

THERMAL RESISTANCE

| | | | | |
|--|----------------|---|---|---------------|
| From mounting base to heatsink direct mounting | $R_{th\ mb-h}$ | = | 3 | $^{\circ}C/W$ |
| insulated mounting | $R_{th\ mb-h}$ | = | 6 | $^{\circ}C/W$ |

TEMPERATURE

| | | | | |
|---------------------------------|-----------|---|-----|-------------|
| Maximum permissible temperature | T_{max} | = | 100 | $^{\circ}C$ |
|---------------------------------|-----------|---|-----|-------------|

MOUNTING INSTRUCTIONS

Insulated mounting:

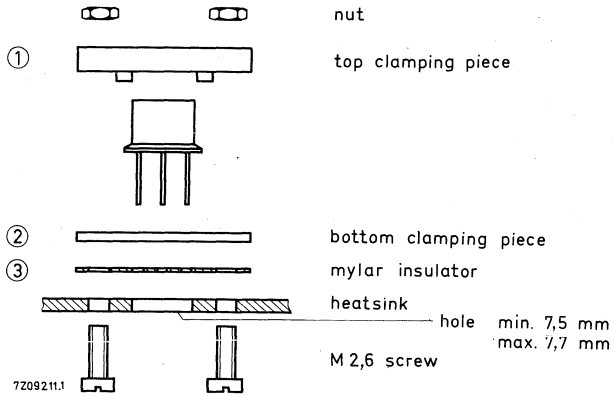

Direct mounting: without items 2 and 3; item 1 to be mounted upside-down.

56245
56246
56263

DISTANCE DISCS

MECHANICAL DATA

Dimensions in mm

56245

56246

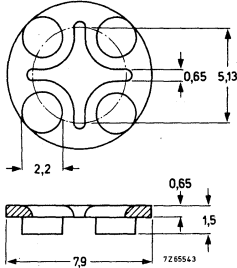

Insulating material

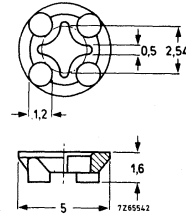

Insulating material

TEMPERATURE

Maximum permissible temperature

T max. 100 °C

56263

COOLING FIN

MECHANICAL DATA

Dimensions in mm

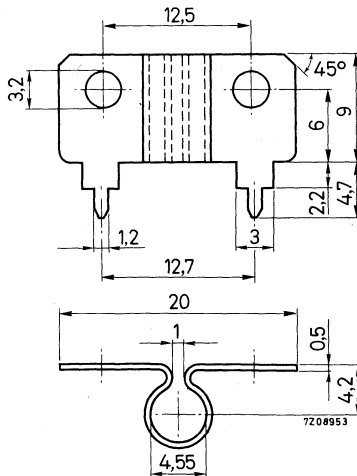

Material: copper, tin plated

THERMAL RESISTANCE

From case to ambient

$R_{th\ c-a} = 100\ ^\circ C/W$

WASHER

Flat metal washer for non-insulated mounting of envelope SOT-32 (TO-126).

MECHANICAL DATA

Dimensions in mm

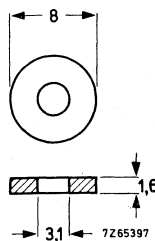

MOUNTING INSTRUCTIONS

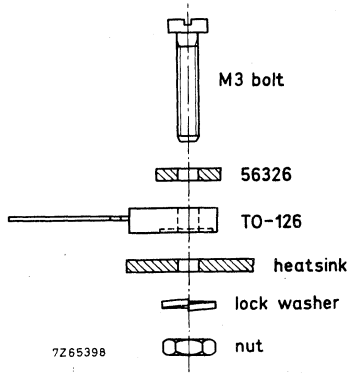

| | |
|--|-----------------|
| Minimum torque on nut for good heat transfer | 4 kgcm (0,4 Nm) |
| Maximum torque on nut | 6 kgcm (0,6 Nm) |
| Minimum thickness of heatsink | 2 mm |

The heatsink surface must appear flat and smooth, without burrs or scratches. If the hole in the heatsink is threaded, it should be countersunk and free of burrs; the hole should also be perpendicular to the plane of the heatsink, within 2° tolerance (for M3 thread).

For mounting on a heatsink the use of a heat conducting compound is recommended.

THERMAL RESISTANCE

From mounting base to heatsink

$$R_{th\ mb-h} = 1\ ^\circ C/W$$

See also the graph.

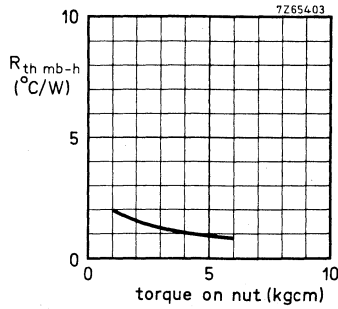

MOUNTING ACCESSORIES

Mounting accessories for insulated mounting of envelope SOT-32 (TO-126); the set consists of a metal washer, a mica washer and an insulating bush.

MECHANICAL DATA

Dimensions in mm

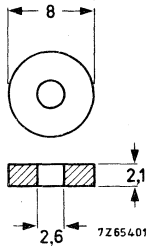

Metal washer

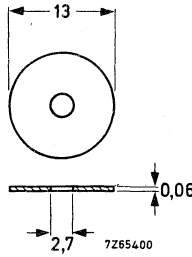

Mica washer

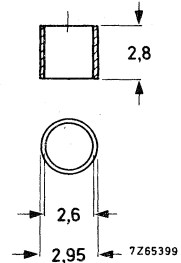

Insulating bush

MOUNTING INSTRUCTIONS

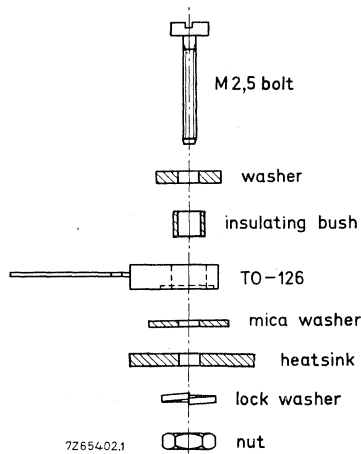

Minimum torque on nut for good heat transfer

4 kgcm (0,4 Nm)

Maximum torque on nut

6 kgcm (0,6 Nm)

Minimum thickness of heatsink

2 mm

MOUNTING INSTRUCTIONS (continued)

The heatsink surface must appear flat and smooth, without burrs or scratches. If the hole in the heatsink is threaded, it should be countersunk and free of burrs; the hole should also be perpendicular to the plane of the heatsink, within 10° tolerance (for M2, 5 thread). For good heat transfer the use of a heatsink compound is recommended.

THERMAL RESISTANCE

From mounting base to heatsink

(a) without heatsink compound

$$R_{th\ mb-h} = 6\ ^{\circ}C/W$$

(b) with heatsink compound

$$R_{th\ mb-h} = 3\ ^{\circ}C/W$$

See also the graph.

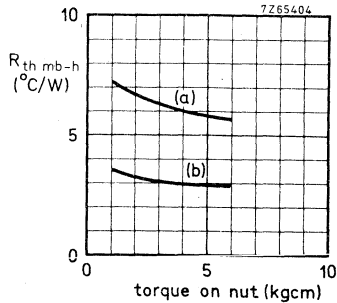

COOLING CLIP FOR TO-92 VARIANT

MECHANICAL DATA

Dimensions in mm

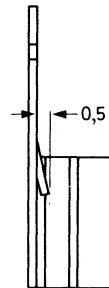
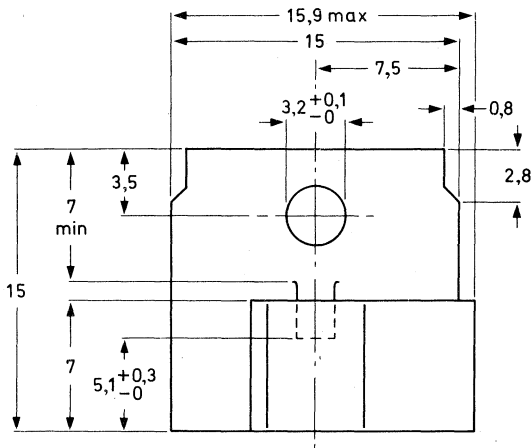

7270841

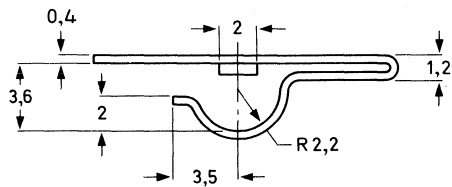

Material: steel, aluminium plated.

INDEX OF TYPE NUMBERS

The inclusion of a type number in this publication does not necessarily imply its availability.

| Type No. | Part | Section | Type No. | Part | Section | Type No. | Part | Section |
|----------|------|---------|----------|------|---------|----------|------|---------|
| AA119 | 1b | PC | ASY27 | 3 | Sw | BAV10 | 1b | WD |
| AA21 | 1b | PC | ASY28 | 3 | Sw | BAV18 | 1b | WD |
| AA30 | 1b | GB | ASY29 | 3 | Sw | BAV19 | 1b | WD |
| AA32 | 1b | GB | ASY73 | 3 | Sw | BAV20 | 1b | WD |
| AAZ13 | 1b | GB | ASY74 | 3 | Sw | BAV21 | 1b | WD |
| AAZ15 | 1b | GB | ASY75 | 3 | Sw | BAV45 | 1b | Sp |
| AAZ17 | 1b | GB | ASZ15 | 2 | P | BAV70 | 4a | Mm |
| AAZ18 | 1b | GB | ASZ16 | 2 | P | BAV99 | 4a | Mm |
| AC125 | 2 | LF | ASZ17 | 2 | P | BAW56 | 4a | Mm |
| AC126 | 2 | LF | ASZ18 | 2 | P | BAW62 | 1b | WD |
| AC127 | 2 | LF | BA100 | 1b | AD | BAX12 | 1b | WD |
| AC128 | 2 | LF | BA102 | 1b | T | BAX13 | 1b | WD |
| AC128/01 | 2 | LF | BA145 | 1a | R | BAX14 | 1b | WD |
| AC132 | 2 | LF | BA148 | 1a | R | BAX15 | 1b | WD |
| AC187 | 2 | LF | BA182 | 1b | T | BAX16 | 1b | WD |
| AC187/01 | 2 | LF | BA216 | 1b | WD | BAX17 | 1b | WD |
| AC188 | 2 | LF | BA217 | 1b | WD | BAX18 | 1b | WD |
| AC188/01 | 2 | LF | BA218 | 1b | WD | BB105A | 1b | T |
| AD161 | 2 | P | BA219 | 1b | WD | BB105B | 1b | T |
| AD162 | 2 | P | BA220 | 1b | WD | BB105G | 1b | T |
| AF124 | 3 | HF | BA221 | 1b | WD | BB106 | 1b | T |
| AF125 | 3 | HF | BA222 | 1b | WD | BB110B | 1b | T |
| AF126 | 3 | HF | BA243 | 1b | T | BB110G | 1b | T |
| AF127 | 3 | HF | BA244 | 1b | T | BB117 | 1b | T |
| AF139 | 3 | HF | BA314 | 1b | Vrg | BB204B | 1b | T |
| AF239 | 3 | HF | BA315 | 1b | Vrg | BB204G | 1b | T |
| AF239S | 3 | HF | BA316 | 1b | WD | BB205A | 1b | T |
| AF367 | 3 | HF | BA317 | 1b | WD | BB205B | 1b | T |
| AF369 | 3 | HF | BA318 | 1b | WD | BB205G | 1b | T |
| ASY26 | 3 | Sw | BA379 | 1b | T | BBY31 | 4a | Mm |

AD = Silicon alloyed diodes
 GB = Germanium gold-bonded diodes
 HF = High-frequency transistors
 LF = Low-frequency transistors
 Mm = Microminiature devices for
 thick- and thin-film circuits
 P = Low-frequency power transistors

PC = Germanium point contact diodes
 R = Rectifier diodes
 Sp = Special diodes
 Sw = Switching transistors
 T = Tuner diodes
 Vrg = Voltage regulator diodes
 WD = Silicon whiskerless diodes

INDEX

| Type No. | Part | Section | Type No. | Part | Section | Type No. | Part | Section |
|----------|------|---------|----------|------|---------|----------|------|---------|
| BC107 | 2 | LF | BC556 | 2 | LF | BCY71 | 2 | LF |
| BC108 | 2 | LF | BC557 | 2 | LF | BCY72 | 2 | LF |
| BC109 | 2 | LF | BC558 | 2 | LF | BCY87 | 4a | DT |
| BC146 | 2 | LF | BC559 | 2 | LF | BCY88 | 4a | DT |
| BC147 | 2 | LF | BC560 | 2 | LF | BCY89 | 4a | DT |
| BC148 | 2 | LF | BC635 | 2 | LF | BD115 | 2 | P |
| BC149 | 2 | LF | BC636 | 2 | LF | BD131 | 2 | P |
| BC157 | 2 | LF | BC637 | 2 | LF | BD132 | 2 | P |
| BC158 | 2 | LF | BC638 | 2 | LF | BD133 | 2 | P |
| BC159 | 2 | LF | BC639 | 2 | LF | BD135 | 2 | P |
| BC177 | 2 | LF | BC640 | 2 | LF | BD136 | 2 | P |
| BC178 | 2 | LF | BCW29 | 4a | Mm | BD137 | 2 | P |
| BC179 | 2 | LF | BCW30 | 4a | Mm | BD138 | 2 | P |
| BC200 | 2 | LF | BCW31 | 4a | Mm | BD139 | 2 | P |
| BC264A | 4a | FET | BCW32 | 4a | Mm | BD140 | 2 | P |
| BC264B | 4a | FET | BCW33 | 4a | Mm | BD181 | 2 | P |
| BC264C | 4a | FET | BCW69 | 4a | Mm | BD182 | 2 | P |
| BC264D | 4a | FET | BCW70 | 4a | Mm | BD183 | 2 | P |
| BC327 | 2 | LF | BCW71 | 4a | Mm | BD201 | 2 | P |
| BC328 | 2 | LF | BCW72 | 4a | Mm | BD202 | 2 | P |
| BC337 | 2 | LF | BCX17 | 4a | Mm | BD203 | 2 | P |
| BC338 | 2 | LF | BCX18 | 4a | Mm | BD204 | 2 | P |
| BC368 | 2 | LF | BCX19 | 4a | Mm | BD226 | 2 | P |
| BC369 | 2 | LF | BCX20 | 4a | Mm | BD227 | 2 | P |
| BC407 | 2 | LF | BCY30A | 2 | LF | BD228 | 2 | P |
| BC408 | 2 | LF | BCY31A | 2 | LF | BD229 | 2 | P |
| BC409 | 2 | LF | BCY32A | 2 | LF | BD230 | 2 | P |
| BC417 | 2 | LF | BCY33A | 2 | LF | BD231 | 2 | P |
| BC418 | 2 | LF | BCY34A | 2 | LF | BD232 | 2 | P |
| BC419 | 2 | LF | BCY55 | 4a | DT | BD233 | 2 | P |
| BC546 | 2 | LF | BCY56 | 2 | LF | BD234 | 2 | P |
| BC547 | 2 | LF | BCY57 | 2 | LF | BD235 | 2 | P |
| BC548 | 2 | LF | BCY58 | 2 | LF | BD236 | 2 | P |
| BC549 | 2 | LF | BCY59 | 2 | LF | BD237 | 2 | P |
| BC550 | 2 | LF | BCY70 | 2 | LF | BD238 | 2 | P |

DT = Dual transistors

FET = Field-effect transistors

LF = Low-frequency transistors

Mm = Microminiature devices for
thick- and thin-film circuits

P = Low-frequency power transistors

INDEX

| Type No. | Part | Section | Type No. | Part | Section | Type No. | Part | Section |
|----------|------|---------|----------|------|---------|----------|------|---------|
| BD262 | 2 | P | BD680 | 2 | P | BDY96 | 2 | P |
| BD262A | 2 | P | BD681 | 2 | P | BDY97 | 2 | P |
| BD262B | 2 | P | BD682 | 2 | P | BF115 | 3 | HF |
| BD263 | 2 | P | BDX62 | 2 | P | BF167 | 3 | HF |
| BD263A | 2 | P | BDX62A | 2 | P | BF173 | 3 | HF |
| BD263B | 2 | P | BDX62B | 2 | P | BF177 | 3 | HF |
| BD291 | 2 | P | BDX63 | 2 | P | BF178 | 3 | HF |
| BD292 | 2 | P | BDX63A | 2 | P | BF179 | 3 | HF |
| BD293 | 2 | P | BDX63B | 2 | P | BF180 | 3 | HF |
| BD294 | 2 | P | BDX64 | 2 | P | BF181 | 3 | HF |
| BD329 | 2 | P | BDX64A | 2 | P | BF182 | 3 | HF |
| BD330 | 2 | P | BDX64B | 2 | P | BF183 | 3 | HF |
| BD331 | 2 | P | BDX65 | 2 | P | BF184 | 3 | HF |
| BD332 | 2 | P | BDX65A | 2 | P | BF185 | 3 | HF |
| BD333 | 2 | P | BDX65B | 2 | P | BF194 | 3 | HF |
| BD334 | 2 | P | BDX66 | 2 | P | BF195 | 3 | HF |
| BD335 | 2 | P | BDX66A | 2 | P | BF196 | 3 | HF |
| BD336 | 2 | P | BDX66B | 2 | P | BF197 | 3 | HF |
| BD433 | 2 | P | BDX67 | 2 | P | BF198 | 3 | HF |
| BD434 | 2 | P | BDX67A | 2 | P | BF199 | 3 | HF |
| BD435 | 2 | P | BDX67B | 2 | P | BF200 | 3 | HF |
| BD436 | 2 | P | BDX77 | 2 | P | BF240 | 3 | HF |
| BD437 | 2 | P | BDX78 | 2 | P | BF241 | 3 | HF |
| BD438 | 2 | P | BDX91 | 2 | P | BF244A | 4a | FET |
| BD645 | 2 | P | BDX92 | 2 | P | BF244B | 4a | FET |
| BD646 | 2 | P | BDX93 | 2 | P | BF244C | 4a | FET |
| BD647 | 2 | P | BDX94 | 2 | P | BF245A | 4a | FET |
| BD648 | 2 | P | BDX95 | 2 | P | BF245B | 4a | FET |
| BD649 | 2 | P | BDX96 | 2 | P | BF245C | 4a | FET |
| BD650 | 2 | P | BDY20 | 2 | P | BF256A | 4a | FET |
| BD675 | 2 | P | BDY90 | 2 | P | BF256B | 4a | FET |
| BD676 | 2 | P | BDY91 | 2 | P | BF256C | 4a | FET |
| BD677 | 2 | P | BDY92 | 2 | P | BF324 | 3 | HF |
| BD678 | 2 | P | BDY93 | 2 | P | BF336 | 3 | HF |
| BD679 | 2 | P | BDY94 | 2 | P | BF337 | 3 | HF |

FET = Field-effect transistors
 HF = High-frequency transistors

P = Low-frequency power transistors

INDEX

| Type No. | Part | Section | Type No. | Part | Section | Type No. | Part | Section |
|----------|------|---------|------------|------|---------|----------|------|---------|
| BF338 | 3 | HF | BFS21 | 4a | FET | BLX65 | 4a | Tra |
| BF362 | 3 | HF | BFS21A | 4a | FET | BLX66 | 4a | Tra |
| BF363 | 3 | HF | BFS22A | 4a | Tra | BLX67 | 4a | Tra |
| BF422 | 3 | HF | BFS23A | 4a | Tra | BLX68 | 4a | Tra |
| BF423 | 3 | HF | BFS28 | 4a | FET | BLX69 | 4a | Tra |
| BF450 | 3 | HF | BFS92 | 3 | HF | BLX91 | 4a | Tra |
| BF451 | 3 | HF | BFS93 | 3 | HF | BLX92 | 4a | Tra |
| BF457 | 3 | HF | BFS94 | 3 | HF | BLX93 | 4a | Tra |
| BF458 | 3 | HF | BFS95 | 3 | HF | BLX94A | 4a | Tra |
| BF459 | 3 | HF | BFT24 | 3 | HF | BLX95 | 4a | Tra |
| BF480 | 3 | HF | BFT25 | 4a | Mm | BLX96 | 4a | Tra |
| BF494 | 3 | HF | BFW10 | 4a | FET | BLX97 | 4a | Tra |
| BF495 | 3 | HF | BFW11 | 4a | FET | BLY83 | 4a | Tra |
| BFQ10 | 4a | FET | BFW12 | 4a | FET | BLY84 | 4a | Tra |
| BFQ11 | 4a | FET | BFW13 | 4a | FET | BLY87A | 4a | Tra |
| BFQ12 | 4a | FET | BFW16A | 3 | HF | BLY88A | 4a | Tra |
| BFQ13 | 4a | FET | BFW17A | 3 | HF | BLY89A | 4a | Tra |
| BFQ14 | 4a | FET | BFW30 | 3 | HF | BLY90 | 4a | Tra |
| BFQ15 | 4a | FET | BFW45 | 3 | HF | BLY91A | 4a | Tra |
| BFQ16 | 4a | FET | BFW61 | 4a | FET | BLY92A | 4a | Tra |
| BFR29 | 4a | FET | BFW92 | 3 | HF | BLY93A | 4a | Tra |
| BFR30 | 4a | Mm | BFW93 | 3 | HF | BLY94 | 4a | Tra |
| BFR31 | 4a | Mm | BFX34 | 3 | Sw | BPX25 | 4b | PDT |
| BFR53 | 4a | Mm | BFX89 | 3 | HF | BPX29 | 4b | PDT |
| BFR64 | 3 | HF | BFY50 | 3 | HF | BPX40 | 4b | PDT |
| BFR65 | 3 | HF | BFY51 | 3 | HF | BPX41 | 4b | PDT |
| BFR90 | 3 | HF | BFY52 | 3 | HF | BPX42 | 4b | PDT |
| BFR91 | 3 | HF | BFY55 | 3 | HF | BPX66P | 4b | PDT |
| BFR92 | 4a | Mm | BFY90 | 3 | HF | BPX70 | 4b | PDT |
| BFR93 | 4a | Mm | BG1895-541 | 1a | R | BPX71 | 4b | PDT |
| BFR94 | 3 | HF | BG1895-641 | 1a | R | BPX72 | 4b | PDT |
| BFS17 | 4a | Mm | BLW60 | 4a | Tra | BPX95 | 4b | PDT |
| BFS18 | 4a | Mm | BLX13 | 4a | Tra | BR100 | 1a | Th |
| BFS19 | 4a | Mm | BLX14 | 4a | Tra | BR101 | 3 | Sw |
| BFS20 | 4a | Mm | BLX15 | 4a | Tra | BR Y39 | 1a | Th |

FET = Field-effect transistors
 HF = High-frequency transistors
 Mm = Microminiature devices for
 thick- and thin-film circuits
 PDT = Photodiodes or transistors

R = Rectifier diodes
 Sw = Switching transistors
 Th = Thyristors, diacs
 Tra = Transmitting transistors

INDEX

| Type No. | Part | Section | Type No. | Part | Section | Type No. | Part | Section |
|--------------|------|---------|--------------|------|---------|--------------|------|---------|
| BR Y39(SCS) | 3 | Sw | BTW32 series | 1a | Th | BY206 | 1a | R |
| BR Y39(PUT) | 3 | Sw | BTW33 series | 1a | Th | BY207 | 1a | R |
| BSS38 | 3 | Sw | BTW34 series | 1a | Tri | BY208 series | 1a | R |
| BSS40 | 3 | Sw | BTW38 series | 1a | Th | BY209 | 1a | R |
| BSS41 | 3 | Sw | BTW40 series | 1a | Th | BY223 | 1a | R |
| BSS50 | 3 | Sw | BTW42 series | 1a | Th | BY409 | 1a | R |
| BSS51 | 3 | Sw | BTW43 series | 1a | Tri | BY476 | 1a | R |
| BSS52 | 3 | Sw | BTW45 series | 1a | Th | BYX10 | 1a | R |
| BSS68 | 3 | Sw | BTW47 series | 1a | Th | BYX22 series | 1a | R |
| BSV15 | 3 | Sw | BTW92 series | 1a | Th | BYX25 series | 1a | R |
| BSV16 | 3 | Sw | BTX18 series | 1a | Th | BYX29 series | 1a | R |
| BSV17 | 3 | Sw | BTX94 series | 1a | Tri | BYX30 series | 1a | R |
| BSV52 | 4a | Mm | BTX95 series | 1a | Th | BYX32 series | 1a | R |
| BSV64 | 3 | Sw | BTY79 series | 1a | Th | BYX35 | 1a | R |
| BSV78 | 4a | FET | BTY87 series | 1a | Th | BYX36 series | 1a | R |
| BSV79 | 4a | FET | BTY91 series | 1a | Th | BYX38 series | 1a | R |
| BSV80 | 4a | FET | BU105 | 2 | P | BYX39 series | 1a | R |
| BSV81 | 4a | FET | BU108 | 2 | P | BYX42 series | 1a | R |
| BSW41 | 3 | Sw | BU126 | 2 | P | BYX45 series | 1a | R |
| BSW66 | 3 | Sw | BU132 | 2 | P | BYX46 series | 1a | R |
| BSW67 | 3 | Sw | BU133 | 2 | P | BYX48 series | 1a | R |
| BSW68 | 3 | Sw | BU204 | 2 | P | BYX49 series | 1a | R |
| BSX19 | 3 | Sw | BU205 | 2 | P | BYX50 series | 1a | R |
| BSX20 | 3 | Sw | BU206 | 2 | P | BYX52 series | 1a | R |
| BSX21 | 3 | Sw | BU207A | 2 | P | BYX55 series | 1a | R |
| BSX59 | 3 | Sw | BU208A | 2 | P | BYX56 series | 1a | R |
| BSX60 | 3 | Sw | BU209A | 2 | P | BYX71 series | 1a | R |
| BSX61 | 3 | Sw | BY126 | 1a | R | BYX90 | 1a | R |
| BT126 | 1a | Th | BY127 | 1a | R | BYX91 series | 1a | R |
| BT128 series | 1a | Th | BY164 | 1a | R | BYX96 series | 1a | R |
| BT129 series | 1a | Th | BY176 | 1a | R | BYX97 series | 1a | R |
| BTW23 series | 1a | Th | BY179 | 1a | R | BYX98 series | 1a | R |
| BTW24 series | 1a | Th | BY184 | 1a | R | BYX99 series | 1a | R |
| BTW30 series | 1a | Th | BY187 | 1a | R | BZV10 | 1b | Vrf |
| BTW31 series | 1a | Th | BY188 series | 1a | R | BZV11 | 1b | Vrf |

FET = Field-effect transistors
 Mm = Microminiature devices for
 thick- and thin-film circuits
 P = Low-frequency power transistors
 R = Rectifier diodes

Sw = Switching transistors
 Th = Thyristors, diacs
 Tri = Triacs
 Vrf = Voltage reference diodes

INDEX

| Type No. | Part | Section | Type No. | Part | Section | Type No. | Part | Section |
|--------------|------|---------|----------|------|---------|----------|------|---------|
| BZV12 | 1b | Vrf | BZZ23 | 1a | Vrg | ORP60 | 4b | Ph |
| BZV13 | 1b | Vrf | BZZ24 | 1a | Vrg | ORP61 | 4b | Ph |
| BZV14 | 1b | Vrf | BZZ25 | 1a | Vrg | ORP62 | 4b | Ph |
| BZV15 series | 1a | Vrg | BZZ26 | 1a | Vrg | ORP66 | 4b | Ph |
| BZV38 | 1b | Vrf | BZZ27 | 1a | Vrg | ORP68 | 4b | Ph |
| BZW70 series | 1a | TS | BZZ28 | 1a | Vrg | ORP69 | 4b | Ph |
| BZW86 series | 1a | TS | BZZ29 | 1a | Vrg | ORP90 | 4b | Ph |
| BZW91 series | 1a | TS | CNY22 | 4b | PhC | OSB9110 | 1a | St |
| BZW93 series | 1a | TS | CNY23 | 4b | PhC | OSB9210 | 1a | St |
| BZX55 series | 1b | Vrg | CNY42 | 4b | PhC | OSB9310 | 1a | St |
| BZX61 series | 1b | Vrg | CNY43 | 4b | PhC | OSB9410 | 1a | St |
| BZX70 series | 1a | Vrg | CNY44 | 4b | PhC | OSM9110 | 1a | St |
| BZX75 series | 1b | Vrg | CNY46 | 4b | PhC | OSM9210 | 1a | St |
| BZX79 series | 1b | Vrg | CNY47 | 4b | PhC | OSM9310 | 1a | St |
| BZX84 series | 4a | Mm | CNY47A | 4b | PhC | OSM9410 | 1a | St |
| BZX87 series | 1b | Vrg | CQY11B | 4b | LED | OSS9110 | 1a | St |
| BZX90 | 1b | Vrf | CQY11C | 4b | LED | OSS9210 | 1a | St |
| BZX91 | 1b | Vrf | CQY24 | 4b | LED | OSS9310 | 1a | St |
| BZX92 | 1b | Vrf | CQY46 | 4b | LED | OSS9410 | 1a | St |
| BZX93 | 1b | Vrf | CQY47 | 4b | LED | RPY18 | 4b | Ph |
| BZY78 | 1b | Vrf | CQY50 | 4b | LED | RPY19 | 4b | Ph |
| BZY88 series | 1b | Vrg | CQY52 | 4b | LED | RPY20 | 4b | Ph |
| BZY91 series | 1a | Vrg | CQY53 | 4b | LED | RPY33 | 4b | Ph |
| BZY93 series | 1a | Vrg | CQY54 | 4b | LED | RPY55 | 4b | Ph |
| BZY95 series | 1a | Vrg | CQY61 | 4b | LED | RPY58A | 4b | Ph |
| BZY96 series | 1a | Vrg | OA47 | 1b | GB | RPY71 | 4b | Ph |
| BZZ14 | 1a | Vrg | OA90 | 1b | PC | RPY76A | 4b | I |
| BZZ15 | 1a | Vrg | OA91 | 1b | PC | RPY82 | 4b | Ph |
| BZZ16 | 1a | Vrg | OA95 | 1b | PC | RPY84 | 4b | Ph |
| BZZ17 | 1a | Vrg | OA200 | 1b | AD | RPY85 | 4b | Ph |
| BZZ18 | 1a | Vrg | OA202 | 1b | AD | IN821 | 1b | Vrf |
| BZZ19 | 1a | Vrg | ORP10 | 4b | I | IN823 | 1b | Vrf |
| BZZ20 | 1a | Vrg | ORP13 | 4b | I | IN825 | 1b | Vrf |
| BZZ21 | 1a | Vrg | ORP23 | 4b | Ph | IN827 | 1b | Vrf |
| BZZ22 | 1a | Vrg | ORP52 | 4b | Ph | IN829 | 1b | Vrf |

AD = Silicon alloyed diodes
 GB = Germanium gold-bonded diodes
 I = Infrared devices
 LED = Light emitting diodes
 Mm = Microminiature devices for
 thick- and thin-film circuits
 PC = Germanium point contact diodes

Ph = Photoconductive devices
 PhC = Photocouplers
 St = Rectifier stacks
 TS = Transient suppressor diodes
 Vrf = Voltage reference diodes
 Vrg = Voltage regulator diodes

INDEX

| Type No. | Part | Section | Type No. | Part | Section | Type No. | Part | Section |
|----------|------|---------|----------|------|---------|----------|------|---------|
| IN914 | 1b | WD | IN5752B | 1b | Vrg | 2N2894A | 3 | Sw |
| IN914A | 1b | WD | IN5753B | 1b | Vrg | 2N2904 | 3 | Sw |
| IN916 | 1b | WD | IN5754B | 1b | Vrg | 2N2904A | 3 | Sw |
| IN916A | 1b | WD | IN5755B | 1b | Vrg | 2N2905 | 3 | Sw |
| IN916B | 1b | WD | IN5756B | 1b | Vrg | 2N2905A | 3 | Sw |
| IN4009 | 1b | WD | IN5757B | 1b | Vrg | 2N2906 | 3 | Sw |
| IN4148 | 1b | WD | 2N918 | 3 | HF | 2N2906A | 3 | Sw |
| IN4150 | 1b | WD | 2N929 | 2 | LF | 2N2907 | 3 | Sw |
| IN4151 | 1b | WD | 2N930 | 2 | LF | 2N2907A | 3 | Sw |
| IN4154 | 1b | WD | 2N1302 | 3 | Sw | 2N3019 | 3 | Sw |
| IN4446 | 1b | WD | 2N1303 | 3 | Sw | 2N3020 | 3 | Sw |
| IN4448 | 1b | WD | 2N1304 | 3 | Sw | 2N3055 | 2 | P |
| IN5729B | 1b | Vrg | 2N1305 | 3 | Sw | 2N3375 | 4a | Tra |
| IN5730B | 1b | Vrg | 2N1306 | 3 | Sw | 2N3442 | 2 | P |
| IN5731B | 1b | Vrg | 2N1307 | 3 | Sw | 2N3553 | 4a | Tra |
| IN5732B | 1b | Vrg | 2N1308 | 3 | Sw | 2N3632 | 4a | Tra |
| IN5733B | 1b | Vrg | 2N1309 | 3 | Sw | 2N3819 | 4a | FET |
| IN5734B | 1b | Vrg | 2N1613 | 3 | HF | 2N3823 | 4a | FET |
| IN5735B | 1b | Vrg | 2N1711 | 3 | HF | 2N3866 | 4a | Tra |
| IN5736B | 1b | Vrg | 2N1893 | 3 | HF | 2N3924 | 4a | Tra |
| IN5737B | 1b | Vrg | 2N2218 | 3 | Sw | 2N3926 | 4a | Tra |
| IN5738B | 1b | Vrg | 2N2218A | 3 | Sw | 2N3927 | 4a | Tra |
| IN5739B | 1b | Vrg | 2N2219 | 3 | Sw | 2N3966 | 4a | FET |
| IN5740B | 1b | Vrg | 2N2219A | 3 | Sw | 2N4036 | 3 | Sw |
| IN5741B | 1b | Vrg | 2N2221 | 3 | Sw | 2N4091 | 4a | FET |
| IN5742B | 1b | Vrg | 2N2221A | 3 | Sw | 2N4092 | 4a | FET |
| IN5743B | 1b | Vrg | 2N2222 | 3 | Sw | 2N4093 | 4a | FET |
| IN5744B | 1b | Vrg | 2N2222A | 3 | Sw | 2N4347 | 2 | P |
| IN5745B | 1b | Vrg | 2N2297 | 3 | HF | 2N4391 | 4a | FET |
| IN5746B | 1b | Vrg | 2N2368 | 3 | Sw | 2N4392 | 4a | FET |
| IN5747B | 1b | Vrg | 2N2369 | 3 | Sw | 2N4393 | 4a | FET |
| IN5748B | 1b | Vrg | 2N2369A | 3 | Sw | 2N4427 | 4a | Tra |
| IN5749B | 1b | Vrg | 2N2483 | 3 | HF | 2N4856 | 4a | FET |
| IN5750B | 1b | Vrg | 2N2484 | 3 | HF | 2N4857 | 4a | FET |
| IN5751B | 1b | Vrg | 2N2894 | 3 | Sw | 2N4858 | 4a | FET |

FET = Field-effect transistors
 HF = High-frequency transistors
 LF = Low-frequency transistors
 P = Low-frequency power transistors

Sw = Switching transistors
 Tra = Transmitting transistors
 Vrg = Voltage regulator diodes
 WD = Silicon whiskerless diodes

INDEX

| Type No. | Part | Section | Type No. | Part | Section | Type No. | Part | Section |
|----------|----------|---------|----------|----------|---------|----------|------|---------|
| 2N4859 | 4a | FET | 56246 | 1a to 4a | A | 56315 | 1a | DH |
| 2N4860 | 4a | FET | 56253 | 1a | DH | 56316 | 1a | A |
| 2N4861 | 4a | FET | 56256 | 1a | DH | 56318 | 1a | DH |
| 61SV | 4b | I | 56261 | 2 | A | 56319 | 1a | DH |
| 40809 | 2 | LF | 56262A | 1a | A | 56326 | 2, 3 | A |
| 40820 | 3 | HF | 56263 | 1a to 4a | A | 56333 | 2, 3 | A |
| 40835 | 3 | HF | 56264A | 1a | A | 56334 | 1a | DH |
| 40838 | 3 | HF | 56268 | 1a | DH | 56337 | 1a | A |
| 56200 | 2, 3, 4a | A | 56271 | 1a | DH | 56339 | 2 | A |
| 56201 | 2 | A | 56278 | 1a | DH | 56348 | 1a | DH |
| 56201c | 2 | A | 56280 | 1a | DH | 56349 | 1a | DH |
| 56201d | 2 | A | 56290 | 1a | HE | 56350 | 1a | DH |
| 56203 | 2 | A | 56293 | 1a | HE | 56351 | 2 | A |
| 56218 | 2, 3, 4a | A | 56295 | 1a | A | 56352 | 2 | A |
| 56230 | 1a | HE | 56299 | 1a | A | 56353 | 2 | A |
| 56231 | 1a | HE | 56309B | 1a | A | 56354 | 2 | A |
| 56233 | 1a | A | 56309R | 1a | A | 56356 | 2, 3 | A |
| 56234 | 1a | A | 56312 | 1a | DH | 56359 | 2 | A |
| 56239 | 2 | A | 56313 | 1a | DH | 56360 | 2 | A |
| 56245 | 2, 3, 4a | A | 56314 | 1a | DH | | | |

A = Accessories

DH = Diecast heatsinks

FET = Field-effect transistors

HE = Heatsink extrusions

HF = High-frequency transistors

I = Infrared devices

LF = Low-frequency transistors

MAINTENANCE TYPE LIST

The type numbers listed below are not included in this handbook except for those marked with an asterisk.

Detailed information will be supplied on request.

| | |
|---------|---------|
| AF121 | ASY80 |
| * AF124 | * BF177 |
| * AF125 | * BF178 |
| * AF126 | * BF179 |
| * AF127 | BFX44 |
| AF240 | BSV68 |
| AF267 | |
| AFZ12 | |
| ASY76 | |
| ASY77 | |



General



High-frequency transistors



Switching transistors



Accessories



Index and maintenance type list

Electronic components and materials for professional, industrial and consumer uses from a world-wide Group of Companies

- Argentina:** FAPESA I.y.C., Av. Crovara 2550, Tel. 652-7438/7478, BUENOS AIRES.
- Australia:** Philips Industries Ltd., Elcoma Division, 67 Mars Road, Tel. 42 1261, LANE COVE, 2066, N.S.W.
- Austria:** Österreichische Philips, Bauelemente Industrie G.m.b.H., Zieglergasse 6, Tel. 93 26 11, A-1072 WIEN.
- Belgium:** M.B.L.E., 80, rue des Deux Gares, Tel. 523 00 00, B-1070 BRUXELLES.
- Brazil:** IBRAPE S.A., Caixa Postal 7383, Av. Paulista 2073-S/Loja, Tel. 287-7144,01311 SAO PAULO, SP.
- Canada:** Philips Electron Devices, 116 Vanderhoof Ave., Tel. 425-5161, TORONTO 17, Ontario.
- Chile:** Philips Chilena S.A., Av. Santa Maria 0760, Tel. 39-40 01, SANTIAGO.
- Colombia:** SADAPE S.A., Calle 19, No. 5-51, Tel. 422-175, BOGOTA D.E. 1.
- Denmark:** Miniwatt A/S, Emdrupvej 115A, Tel. (01) 69 16 22, DK-2400 KØBENHAVN NV.
- Finland:** Oy Philips Ab, Elcoma Division, Kaivokatu 8, Tel. 1 72 71, SF-00100 HELSINKI 10.
- France:** R.T.C., La Radiotechnique-Compelec, 130 Avenue Ledru Rollin, Tel. 355-44-99, F-75540 PARIS 11.
- Germany:** Valvo, UB Bauelemente der Philips G.m.b.H., Valvo Haus, Burchardstrasse 19, Tel. (040) 3296-1, D-2 HAMBURG 1.
- Greece:** Philips S.A. Hellénique, Elcoma Division, 52, Av. Syngrou, Tel. 915 311, ATHENS.
- Hong Kong:** Philips Hong Kong Ltd., Components Dept., 11th Fl., Din Wai Ind. Bldg., 49 Hoi Yuen Rd, Tel. K-42 72 32, KWUNGTONG.
- India:** Elcoma Div. of Philips India Ltd., Band Box House, 254-D, Dr. Annie Besant Rd., Tel. 457 311-5, Prabhadevi, BOMBAY-25-DD.
- Indonesia:** P.T. Philips-Ralin Electronics, Elcoma Division, 'TIMAH' Building, Jl. Jen. Gatot Subroto, Tel. 44 163, JAKARTA.
- Ireland:** Philips Electrical (Ireland) Ltd., Newstead, Clonskeagh, Tel. 69 33 55, DUBLIN 14.
- Italy:** Philips S.p.A., Sezione Elcoma, Piazza IV Novembre 3, Tel. 2-6994, I-20124 MILANO.
- Japan:** NIHON PHILIPS, 32nd Fl., World Trade Center Bldg., 5, 3-chome, Shiba Hamamatsu-cho, Minato-ku, Tel. 03-435-5268, TOKYO.
- Korea:** Philips Electronics Korea Ltd., Philips House, 260-199 Itaewon-dong, Yongsan-ku, Tel. 44-4202, C.P.O. Box 3680, SEOUL.
- Mexico:** Electrónica S.A. de C.V., Varsovia No. 36, Tel. 5-33-11-80, MEXICO 6, D.F.
- Netherlands:** Philips Nederland B.V., Afd. Elonco, Boschdijk 525, Tel. (040) 79 33 33, NL-4510 EINDHOVEN.
- New Zealand:** EDAC Ltd., 70-72 Kingsford Smith Street, Tel. 873 159, WELLINGTON.
- Norway:** Electronica A.S., Vitaminveien 11, Tel. (02) 15 05 90, P.O. Box 29, Grefsen, OSLO 4.
- Peru:** CADESA, Jr. Ilo, No. 216, Apartado 10132, Tel. 27 73 17, LIMA.
- Philippines:** ELDAC, Philips Industrial Dev. Inc., 2246 Pasong Tamo, Tel. 86-89-51 to 59, MAKATI-RIZAL.
- Portugal:** Philips Portuguesa S.A.R.L., Av. Eng. Duarte Pacheco 6, Tel. 68 31 21, LISBOA 1.
- Singapore:** Philips Singapore Private Ltd., Elcoma Div., P.O. Box 340, Toa Payoh Central P.O., Lorong 1, Toa Payoh, Tel. 53 88 11, SINGAPORE 12.
- South Africa:** EDAC (Pty.) Ltd., South Park Lane, New Doornfontein, Tel. 24/6701-2, JOHANNESBURG.
- Spain:** COPRESA S.A., Balmes 22, Tel. 329 63 12, BARCELONA 7.
- Sweden:** ELCOMA A.B., Lidingövägen 50, Tel. 08/67 97 80, S-10 250 STOCKHOLM 27.
- Switzerland:** Philips A.G., Elcoma Dept., Edenstrasse 20, Tel. 01/44 22 11, CH-8027 ZÜRICH.
- Taiwan:** Philips Taiwan Ltd., 3rd Fl., San Min Building, 57-1, Chung Shan N. Rd, Section 2, P.O. Box 22978, Tel. 5513101-5, TAIPEI.
- Turkey:** Türk Philips Ticaret A.S., EMET Department, Gümüşsuyu Cad. 78-80, Tel. 45.32.50, Beyoğlu, ISTANBUL.
- United Kingdom:** Mullard Ltd., Mullard House, Torrington Place, Tel. 01-580 6633, LONDON WC1E 7HD.
- United States:** North American Philips Electronic Component Corp., 230, Duffy Avenue, Tel. (516) 931-6200, HICKSVILLE, N.Y. 11802.
- Uruguay:** Luzilectron S.A., Rõndeau 1567, piso 5, Tel. 9 43 21, MONTEVIDEO.
- Venezuela:** Industrias Venezolanas Philips S.A., Elcoma Dept., Av. Principal de los Ruices, Edif. Centro Colgate, Apdo 1167, Tel. 36.05.11, CARACAS.

©N.V. Philips' Gloeilampenfabrieken